

STUDENTS' MODELING OF FRICTION AT THE MICROSCOPIC LEVEL

by

EDGAR DE GUZMAN CORPUZ

B.S., Philippine Normal University, Manila, Philippines, 1991  
M.S.T., De La Salle University, Manila, Philippines, 1998

AN ABSTRACT OF A DISSERTATION

submitted in partial fulfillment of the requirements for the degree

DOCTOR OF PHILOSOPHY

Department Of Physics  
College of Arts and Sciences

KANSAS STATE UNIVERSITY  
Manhattan, Kansas

2006

## Abstract

Research that investigates the dynamics of knowledge construction by students as they model phenomena at the microscopic level has not been extensively conducted in physics and science education in general. This research wherein I investigated the dynamics of knowledge construction of students in the context of microscopic friction is an attempt to do so.

The study commenced with an investigation of the variations in the existing models of students about microscopic friction (phase I of the study). Clinical interviews were conducted with introductory physics students in order to elicit their models. A phenomenographic approach of data analysis was employed to establish the variations in students' models. Results show that students' mental models of friction at the atomic level are dominated by their macroscopic experiences. Friction at the atomic level according to most students is due to mechanical interactions (interlocking or rubbing of atoms).

Can we build on these macroscopic ideas of students in order to help them construct more scientific explanations of friction at the atomic level? The second phase of the research was an investigation of the dynamics of knowledge construction of students as they constructed models of friction at the atomic level while building on their prior ideas. Individual as well as group teaching interviews were conducted with introductory physics students in order to investigate students learning trajectories and the processes they undergo as they created new models of friction at the atomic level. Results show that the *span, zone of proximal development* and the *epistemological orientations* of the students greatly influenced the extent to which they utilize scaffolding afforded to them during the model-building process. Moreover, results show that students undergo the process of *incorporation* and *displacement* during their model construction and reconstruction.

In the third phase, an instructional material geared towards helping students develop more scientific explanations of microscopic friction was developed and pilot-tested.

Overall, the results of the study have significant implications for further research, in improving instruction, and curriculum material development.

STUDENTS' MODELING OF FRICTION AT THE MICROSCOPIC LEVEL

by

EDGAR DE GUZMAN CORPUZ

B.S., Philippine Normal University, Manila, Philippines, 1991  
M.S.T., De La Salle University, Manila, Philippines, 1998

A DISSERTATION

submitted in partial fulfillment of the requirements for the degree

DOCTOR OF PHILOSOPHY

Department of Physics  
College of Arts And Sciences

KANSAS STATE UNIVERSITY  
Manhattan, Kansas

2006

Approved by:

Major Professor  
N. SANJAY REBELLO

# **Copyright**

EDGAR DE GUZMAN CORPUZ

2006

## Abstract

Research that investigates the dynamics of knowledge construction by students as they model phenomena at the microscopic level has not been extensively conducted in physics and science education in general. This research wherein I investigated the dynamics of knowledge construction of students in the context of microscopic friction is an attempt to do so.

The study commenced with an investigation of the variations in the existing models of students about microscopic friction (phase I of the study). Clinical interviews were conducted with introductory physics students in order to elicit their models. A phenomenographic approach of data analysis was employed to establish the variations in students' models. Results show that students' mental models of friction at the atomic level are dominated by their macroscopic experiences. Friction at the atomic level according to most students is due to mechanical interactions (interlocking or rubbing of atoms).

Can we build on these macroscopic ideas of students in order to help them construct more scientific explanations of friction at the atomic level? The second phase of the research was an investigation of the dynamics of knowledge construction of students as they constructed models of friction at the atomic level while building on their prior ideas. Individual as well as group teaching interviews were conducted with introductory physics students in order to investigate students learning trajectories and the processes they undergo as they created new models of friction at the atomic level. Results show that the *span, zone of proximal development* and the *epistemological orientations* of the students greatly influenced the extent to which they utilize scaffolding afforded to them during the model-building process. Moreover, results show that students undergo the process of *incorporation* and *displacement* during their model construction and reconstruction.

In the third phase, an instructional material geared towards helping students develop more scientific explanations of microscopic friction was developed and pilot-tested.

Overall, the results of the study have significant implications for further research, in improving instruction, and curriculum material development.

# Table of Contents

List of Figures .....	xii
List of Tables .....	xiv
Acknowledgment .....	xviii
Dedication .....	xix
CHAPTER 1 - Introduction .....	1
1.1 Scope of Research.....	1
1.2 Personal Perspective .....	2
1.3 Rationale .....	2
1.3.1 Why Now? – Relevance to New Scientific and Technological Breakthroughs .....	3
1.3.2 Why Friction?.....	4
1.3.3 Why Modeling?.....	5
1.3.4 Why Microscopic Modeling?.....	5
1.4 Broader Impacts .....	6
1.5 Research Questions.....	6
1.6 Research Strategy Overview.....	7
1.7 Road Map of Thesis .....	9
CHAPTER 2 - Review of Related Literature & Studies.....	11
2.1 Introduction.....	11
2.2 Constructivist Perspectives of Learning and Teaching.....	11
2.2.1 Learning as seen by Piaget.....	13
2.2.2 Vygotsky and the Zone of Proximal Development .....	15
2.2.3 Integrating Piaget and Vygotsky .....	17
2.3 Conceptual Change .....	19
2.4 Models and modeling.....	29
2.4.1 Models Defined .....	29
2.4.2 What Model Means in This Study.....	31
2.4.3 Analogical Reasoning .....	31
2.4.4 Microscopic Modeling .....	32
2.5 Microscopic Friction.....	33

2.5.1	Coulombs Interlocking Model .....	33
2.5.2	Molecular Adhesion Model.....	35
2.5.3	Independent Oscillator Model (Tomlinson Model).....	37
2.6	Perspectives on Transfer of Learning .....	42
2.7	Collaborative Learning .....	45
2.8	Motivational Aspect of Learning.....	46
2.8	Pedagogical Framework.....	46
2.9	Theoretical Framework.....	48
2.10	Research Framework .....	49
2.11	Chapter Summary .....	51
CHAPTER 3 - Research Design.....		53
3.1	Introduction.....	53
3.2	Educational Environment.....	53
3.3	Research Setting.....	54
3.4	Research Plan Overview .....	55
3.5	Philosophical, Methodological & Theoretical Perspectives .....	56
3.5.1	Philosophical Assumptions .....	56
	Ontological Assumptions.....	56
	Epistemological Assumptions.....	57
	Assumptions Regarding Human Nature .....	58
3.5.2	Methodological Perspectives.....	58
3.5.3	Theoretical Perspectives.....	59
	Phenomenology.....	59
	Constructivism .....	60
	Transfer of Learning .....	61
3.6	Selecting Research Tools.....	62
3.6.1	Phenomenography.....	62
3.6.2	Credibility .....	64
	Triangulation.....	64
	Member Checks .....	64
	Peer Debriefing.....	65
3.6.3	Dependability .....	65

3.6.4	Clinical Interviews .....	65
3.6.5	Clinical Interviews with Experts .....	67
3.6.6	Teaching Interviews .....	67
3.7	Mapping Appropriate Methodologies, Perspectives, and Research Tools to the Final Research Plan .....	68
3.8	Chapter Summary .....	68
CHAPTER 4 - Phase I – Students’ Mental Models .....		70
4.1	Introduction .....	70
4.2	Methodological Overview .....	70
4.3	Data Gathering Procedures .....	70
4.3.1	Clinical Interviews .....	70
4.5	Data Analysis .....	74
4.6	Students’ Mental Models: Descriptions of Phenomena .....	74
4.6.1	Cause of Friction at the Atomic Level .....	74
4.6.2	Why Static Friction is Greater than Kinetic Friction .....	77
4.7	Students’ Mental Models: Emergent Themes .....	79
4.7.1	Mechanical Interactions .....	79
4.7.2	Bonding .....	79
4.8	Students’ Mental Models: Overall Findings .....	80
4.9	Development of Preliminary Teaching Interview Protocol .....	80
4.9.1	Expert Interviews & Surveys .....	81
4.9.2	Examination of Models in Literature .....	82
4.9.3	Establishing Target Ideas for Students .....	84
4.9.4	Developing the Preliminary Teaching Interview .....	85
4.10	Chapter Summary .....	86
CHAPTER 5 - Phase II: Dynamics of Model Construction .....		88
5.1	Introduction .....	88
5.2	Methodology .....	89
5.3	Data Gathering Procedures .....	90
5.4	Teaching Interviews .....	92
5.4.1	Individual Teaching Interviews .....	92
5.4.2	The Scaffolding Activities .....	93



Activity #1. Feeling and Sketching of Rough & Smooth Surfaces .....	93
Activity #2. Dragging of Wooden Block across a Wooden Plank and Sandpaper Surface	94
Activity #3. Graphing the variation of friction with surface roughness of both surfaces..	95
Activity #4. Metal Block Activity .....	95
Activity #5. Sketching the Pairs of Sliding Surfaces at the Atomic Level .....	96
Activity #6. Paper-Transparency Activity .....	96
Activity #7. Sketching of pairs of Sliding surfaces at the Atomic Level .....	97
Activity #8. Relating the Paper-Transparency Activity with the Metal Blocks Activity ..	97
Activity #9. Revisiting the Friction vs. Roughness Graph .....	98
Activity #10. Dragging of Block along its wide and Narrow Side .....	99
Activity #11. The Balloon Activity .....	99
Activity #12. Mathematical Modeling .....	100
5.4.3 Group Teaching Interview .....	102
5.5 Data Analysis Technique .....	103
5.5 Results .....	105
5.5.1 Individual Teaching Interview Results & Discussions .....	105
5.5.2 Individual Teaching Interview - The Case of George .....	126
5.5.3 Individual Teaching Interview- The Case of Steve & Rose .....	132
5.5.4. Group Teaching Interviews .....	138
5.5.4.1 Group Teaching Interview- The Case of Lynn, Jeff & Meg .....	138
5.5.4.2 Group Teaching Interview- The Case of Gerald & Matt .....	148
5.5.4.3 Group Teaching Interview- The Case of Arthur & Nathan .....	155
5.5.4.4 Group Teaching Interview: The case of Emily and Jacob .....	164
5.5.4.5. Group Teaching Interview: Further Explored .....	175
5.6 Chapter Summary .....	177
CHAPTER 6 - Development, Evaluation & Pilot-Testing of the Instructional Materials .....	179
6.1 Introduction .....	179
6.2 Methodology .....	179
6.2.1. The Development of the Instructional Module .....	179
6.2.2. Content Validation of the Instructional Module .....	183
6.2.3. Formative Evaluation of the Module .....	183
6.2.4 Qualitative Evaluation of the Material (Formative Assessment of Learning) .....	183

6.2.5	Development, Validity and Reliability of the Micro-Friction Test.....	184
6.2.6	Quantitative Evaluation of the Instructional Material.....	186
6.3	Data Gathering Procedures.....	186
6.4	Results.....	187
6.4.1	Students' Attitudes towards the Developed Material.....	187
6.4.2	Students' Conceptual Progression (Formative Assessment of Students' Learning).....	191
6.4.3	Pilot Test of the Instructional Material.....	209
6.5	Chapter Summary.....	218
CHAPTER 7 - Summary and Conclusions.....		220
7.1	Overview of the Study.....	220
7.2	Conclusions.....	222
7.2.1	Research Question #1: What are the variations in the existing models of introductory college physics students regarding microscopic friction?.....	222
7.2.2	Research Question #2: What scaffolding (cues, hints, activities and other external inputs) causes students to reorganize their knowledge about atomic friction?.....	223
7.2.3	Research Question #3: To what extent can students utilize this scaffolding to reorganize and reconstruct their models of atomic friction?.....	224
7.2.4	Research Question #4: What are the variations in students' interactions as they go through a series of model-building activities?.....	225
7.2.5	Research Question #5: What teaching interventions and/or instructional strategies can be designed to help students come up with a more scientifically accepted model of atomic friction?.....	225
7.3	Implications for Research, Curriculum Development & Instruction.....	226
7.3.1	Further Research.....	226
7.3.2	Instruction.....	227
7.3.3	Curriculum Development.....	227
Bibliography.....		230
Appendix A - The Interview Room Set-up.....		237
Appendix B - The Clinical Interview Protocols.....		238
Appendix C - The Teaching Interview Protocols.....		243
Appendix D - The Scaffolding Activities.....		250
Appendix E - Research Plan.....		255
Appendix F - Informed Consent Form.....		266
Appendix G - Questionnaire for Experts.....		268

Appendix H - The Five-Minute Paper .....	270
Appendix I - Demographics of Teaching Interview Participants .....	271
Appendix J - Sample Transcript .....	272
Appendix K - Version of the Instructional Material for Content Validation.....	283
Appendix L - Students' Feedback Questionnaire .....	330
Appendix M - Table of Specifications (Micro-Friction Test) .....	331
Appendix N - Micro-Friction Test.....	332
Appendix O - i-CARE .....	338
Appendix P - Sample Worksheets .....	340
Appendix Q - T-test Results (Students' Perceptions of the Material) .....	342

## List of Figures

Figure 2.1. Dimensions of constructivism and the perspective adopted in the study.....	13
Figure 2.2. Representation of a learner's Zone of Proximal Development (ZPD).....	16
Figure 2.3. Tharp & Gallimore's Four Stage ZPD.....	17
Figure 2.4. Resource Graph.....	26
Figure 2.5: Interactive relationship between models and phenomena.....	30
Figure 2.6: The Interlocking Model.....	35
Figure 2.7: Spot Welds.....	36
Figure 2.8: (a) Two ideal, flat crystals making contact at the plane indicated by the dash lines. (b) Tomlinson Model.....	39
Figure 2.9: Motion of an atom $B_0$ described by the independent oscillator model. ....	40
Figure 2.10: Plot of friction coefficient against surface roughness. ....	41
Figure 2.11: The dynamic transfer model showing various feedback paths.....	44
Figure 2.12: The Transfer Model based on Redish's two-level framework (2004).....	45
Figure 2.13: Karplus' Learning Cycle.....	47
Figure 2.14: Hestenes' Modeling Cycle and Karplus' Learning Cycle.....	47
Figure 2.15: Level Systems of Multiple Representations.....	49
Figure 2.16: Adapted Modeling Cycle.....	50
Figure 3.1: The transfer framework.....	62
Figure 4.1. The interview room.....	73
Figure 4.2. Variation of force of friction with microscopic roughness.....	82
Figure 4.3. Weight is supported by many micro regions.....	83
Figure 4.4. Target Model of Friction vs. Surface Roughness.....	85
Figure 5.1: The teaching interview room.....	91
Figure 5.2: Sketch of a rough surface.....	94
Figure 5.3: Sketch of a smooth surface.....	94
Figure 5.4: Dragging of wooden block.....	94
Figure 5.5: Initial graph of friction force vs. roughness of surfaces.....	95

Figure 5.6: Metal Blocks.....	96
Figure 5.7: Sketch of pairs of sliding surfaces.....	96
Figure 5.8: Paper over a transparency.....	97
Figure 5.9: Modified graph of friction force vs. roughness of surfaces .....	98
Figure 5.10: Block dragged along its wide and narrow sides.....	99
Figure 5.11: Balloon Activity .....	100
Figure 5.12: Group Teaching Interview Room.....	102
Figure 5.13. Modified graph of friction force vs. roughness of the sliding surfaces.....	108
Figure 5.14. Knowledge Construction via Incremental Change Process.....	109
Figure 5.18: Construction of new associations based on previous associations.....	129
Figure 5.19: The Dynamics of Model Construction of Meg, Lynn & Jeff.....	148
Figure 5.20:The Dynamics of Interaction between Matt and Gerald .....	155
Figure 5.21. Dynamics of Model Construction of Nathan and Arthur .....	164
Figure 5.22. One-way Assimmilation.....	175
Figure 5.23. Balanced Participation.....	176
Figure 5.24. Unbalanced Participatioin .....	176
Figure 6.1. The First Cycle of the Modeling Activities .....	180
Figure 6.2. The Second Cycle of the Modeling Activities .....	181
Figure 6.3. Graph of Friction Force vs. Relative Roughness of Both Surfaces.....	182
Figure 6.4. Keeping Track of Students' Conceptual Progression.....	185
Figure 6.5. Keeping Track of Students' Conceptual Development.....	192
Figure 6.6. Pre-test & Post-test Scores of the Experimental & Control Groups .....	210
Figure 6.7. Pre-test vs. Post-test Comparison of the Experimental & Control Groups .....	212
Figure 6.8. Gain Scores per Question in the Two Groups .....	213
Figure 6.9. Differences Caused by the Activities .....	216
Figure 6.10. Students' Experiences with the Differences Encountered .....	217
Figure 7.1. Typical Curriculum Material Development .....	228
Figure 7.2. Alternative Strategy for Curriculum Design and Development.....	228

## List of Tables

Table 1-1. Phases of the Research and Timeline .....	9
Table 2-1: Wittmann’s processes of conceptual change.....	28
Table 4-1: The Informants .....	73
Table 4-2. Models Explaining Static Friction.....	76
Table 4-3. Models Explaining Kinetic Friction.....	77
Table 4-4. Models Explaining the Lubricating Mechanism of Oil.....	78
Table 5-1: Associations made by students in Activity #1 (Feeling & Sketching of Surfaces)...	112
Table 5-2: Variations in the associations made by students in Activity #2 (Dragging of Wooden Block).....	113
Table 5-3: Variations in the associations made by students in Activity #3 (Graphing of Friction Force vs. Roughness).....	114
Table 5-4: Variations in the associations made by students in Activity #4 (Metal Blocks Activity) .....	115
Table 5-5: Variations in the associations made by students in Activity #4 (Metal Blocks Activity) .....	116
Table 5-6: Variations in the associations made by students in Activity #6 (Papers & Transparency Activity) .....	117
Table 5-7: Variations in the associations made by students in Activity #6 (Papers & Transparency Activity) .....	118
Table 5-8: Variations in the associations made by students after Activity #6 (Papers & Transparency) & Activity 7 (Sketching).....	119
Table 5-9: Variations in the associations made by students in Activity # 9 Revisiting & Modifying Graph of Friction Force vs. Roughness).....	120
Table 5-10: Associations made by students in Activity # 10 (Dragging of Wooden Block on its Wide and Narrow Sides).....	121
Table 5-11: Associations made by students in Activity # 10 (Dragging of Wooden Block on its Wide and Narrow Sides).....	122

Table 5-12: Associations made by students in Activity # 11 (Balloon Activity) .....	123
Table 5-13: Associations made by students in Relating the Balloon Activity with the Wooden Block Activity.....	124
Table 5-14: Associations made by students as they go through the mathematical modeling activity.....	125
Table 5-15: Knowledge construction during the metal block activity.....	127
Table 5-16: Knowledge construction during the papers & transparency activity .....	128
Table 5-17: Modifying the graph of friction vs. roughness of the sliding surfaces.....	131
Table 5-18: Scaffolding inputs and ideas generated by Steve and Rose .....	134
Table 5-19: Scaffolding inputs and ideas generated by Steve and Rose (continued).....	135
Table 5-20: Scaffolding inputs and ideas generated by Steve and Rose (continued).....	136
Table 5-21: Scaffolding inputs and ideas generated by Steve and Rose (continued).....	137
Table 5-22. Associations made by students in the Feeling & Sketching of Surfaces.....	140
Table 5-23: Associations made by students in the “Feeling & Sketching of Surfaces” .....	141
Table 5-24: Associations made by students in the Graph of Friction vs. Roughness of Surfaces .....	142
Table 5-25: Associations made by students in the Metal Blocks activity .....	143
Table 5-26: Associations made by students in the Graphing of Friction vs. Roughness of Surfaces activity.....	144
Table 5-27: Associations made by students during the Sketching of Pairs of Sliding Surfaces	145
Table 5-28. Explanations of the Metal Blocks Activity after doing the Papers & Transparency .....	146
Table 5-29: Associations made by students in Activity 1 (Feeling & Sketching of Surfaces)...	151
Table 5-30: Variations in the associations made by students in the Graphing of Friction Force vs. Roughness activity .....	152
Table 5-31: Associations made by students in the Metal Blocks Activity .....	153
Table 5-32: Associations made by students in the “Modifying Graph of Friction Force vs. Roughness” Activity.....	154
Table 5-33. Association made in explaining their observations in dragging the wooden block across wooden plank.....	158
Table 5-34: Associations made from the Wooden Block Activity.....	159

Table 5-35: Associations made by students in the Graphing of Friction vs. Roughness of Surfaces.....	160
Table 5-36: Associations made by students after the Activity on Sketching the Pairs of Sliding Surfaces.....	160
Table 5-37: Associations made by students after the Metal Blocks Activity.....	161
Table 5-38: Associations made by students in the Graphing of Friction vs. Roughness of Surfaces activity.....	162
Table 5-39. Association made in explaining their observations in dragging the wooden block across wooden plank.....	169
Table 5-40: Associations made from the Wooden Block Activity.....	170
Table 5-41: Associations made by students in the Graphing of Friction vs. Roughness of Surfaces.....	171
Table 5-42: Associations made by students after the Metal Blocks Activity.....	172
Table 5-43: Associations made by students in the Papers & Transparency Activity.....	173
Table 5-44. Associations made in Modifying the Graph of Friction Force vs. Surface Roughness.....	174
Table 6-1. Phase III- Participants.....	186
Table 6-2. Students' Attitudes Toward the Developed Material ( <i>General Physics</i> ).....	189
Table 6-3. Students' Attitudes Toward the Developed Material ( <i>Concepts of Physics</i> ).....	190
Table 6-4: Associations made by students before doing the activities.....	194
Table 6-5: Associations made by students regarding rough and smooth surfaces.....	195
Table 6-6: Associations made by students in Graphing Friction Force vs. Roughness.....	196
Table 6-7: Initial Explanation of Students of the Metal Blocks Activity.....	197
Table 6-8: Variations in the associations made by students in Activity #4 (Papers & Transparency Activity).....	198
Table 6-9: Metal Blocks Activity (Explanation 2).....	201
Table 6-10: Variations in the associations made by students in Activity # (Modifying Graph of Friction Force vs. Roughness).....	202
Table 6-11: Ideas of Friction at the Atomic Level (After Papers & Transparency and Metal Blocks Activity).....	205
Table 6-12: Wood Block on its Wide and Narrow Sides (Predictions).....	206



Table 6-13: Explanation of Wood Block on its Wide and Narrow Sides Activity (After Balloon Activity) .....	207
Table 6-14: Ideas of Friction at the Atomic Level.....	208
Table 6-15. T-test for the Control Groups' Pre-Test & Post-Test Scores .....	210
Table 6-16. T-test for the Experimental Group's Pre-Test & Post-Test Scores .....	211
Table 6-17. T-test of Pre-Test Mean Scores of the Control & Experimental Groups .....	211
Table 6-18. T-test of Post-Test Means Scores of the Control & Experimental Groups .....	212
Table 6-19. T-test of the % Gain Scores of the Control & Experimental Groups .....	212

## Acknowledgment

I consider myself fortunate to have the support of many people during the course of this research. I am especially grateful to my advisor Dr. N. Sanjay Rebello for all the scaffolding he afforded me which subsequently broadened my span. Thank you for the constructive comments, and for constantly giving sound advice whenever I need them. I could not have chosen a better advisor. You are simply awesome!

I also would like to thank the members of my supervisory committee, Dr. Dean Zollman, Dr. Amit Chakrabarti, Dr. Larry Scharmann and Dr. Ruth Miller for their constructive comments and suggestions in improving the final copy of my dissertation.

My sincere appreciation also goes to:

My panel of experts, who unconditionally agreed to be my resource persons, Dr. Talat Rahman, Dr. Bruce Law, Dr. Abdelkader Kara, Dr. Ahlam Al Rawi, and Dr. Mark Robbins.

Dr. Peter Fletcher, for his brilliant ideas in organizing this work

Dr. Paula Engelhardt for helping me learn to conduct teaching interviews.

Members of the Physics Education research group for their suggestions during my research talk presentations which widened my perspective.

Kim Coy for making sure the recording materials I needed for the interviews are always sufficient and available.

Peter Nelson for lending me the materials I needed for my interviews.

The student-volunteers for their time and effort in participating in the interviews conducted.

Dr. Dave van Domelen for the help in recruiting student-volunteers.

Lolita, my aunt, for encouraging me to do my graduate studies at K-State.

Evelacio and Dominga, my parents, Edna, Evy, Marivic, Eva, Net, my sisters and Eric, my brother for their support and prayers.

Finally, to my wife Aileen, my daughter Ionna and my son Adair, for inspiring me and cheering me up during those critical times. What I have achieved wouldn't have been possible without you in my life.

## **Dedication**

I lovingly dedicate this work to my family.

# CHAPTER 1 - Introduction

Science and physics educators have long been concerned about helping students develop conceptual knowledge and scientific reasoning skills. Educators have long recognized a gap between what students are taught and what they learn. Over the past several decades physics education researchers have amassed a vast body of research investigating students' misconceptions and difficulties about specific topics in physics. More recently, physics education researchers have begun focusing, not just on students' misconceptions and difficulties, but rather on the ways in which, and the conditions under which students learn. It is at this juncture that the research described in this thesis is situated.

In this chapter of the dissertation I present the different issues pertaining to this research study. The first section discusses the context of the research study within the larger framework of the NSF-funded project that supports this work. In the second section, I describe my personal motivation for doing this research. The proceeding sections present the reasons why I chose the particular topical area of focus and how it is situated within the larger frame of cutting-edge scientific discovery. The chapter concludes with a discussion of the research questions that the study seeks to address and the road map for the rest of the dissertation.

## 1.1 Scope of Research

Research (Barlia and Beeth, 1999; McCombs, 1996; Pintrich, 1996; White, 1959) has shown that learners' motivation and effort to learn increases when they see the usefulness of the topic to their everyday life experiences. In traditional curricula however, real-world examples are often used as applications of concepts that have already been introduced, but seldom are real-world devices or phenomena used to motivate the introduction of a new concept.

The ongoing research and curriculum development in the KSU Physics Education Research Group, under the auspices of an NSF-funded grant titled *Research on Students' Mental Models, Learning and Transfer as a Guide to Application-based Curriculum Development in Physics* investigates the use of everyday phenomena and devices in the teaching and learning of physics. The project has developed a theoretical framework that explains the process through which learners construct knowledge based on external inputs and the factors that mediate

learners' sense making processes. The project has also developed a multi-methodological approach that provides a useful framework to develop curricula based on students' real-world experiences. The research described in this thesis is conducted within the scope of that aforementioned project and adopts the theoretical framework as well as the methodological approach.

## **1.2 Personal Perspective**

In both my research and my teaching I am interested in making the learning of physics more meaningful to students. Research has shown that the use of real-world contexts and devices increases student motivation to learn. However, research has also shown that real-world devices and contexts need to be appropriately integrated into the curriculum. Toward this goal I focus on the creation of research-based instructional materials and strategies to help incorporate real-world contexts into students' learning. I am also interested in conducting research on the dynamics of students' knowledge construction and the conditions under which students learn. I believe that if we can capture how students dynamically construct their ideas, teachers will be in a better position to provide students with pedagogically appropriate scaffolding in order help them learn.

Throughout my teaching career I have strived to help students experience how scientists come to understand complex processes. In explaining and understanding abstract ideas, scientists usually employ models. I believe that modeling should be an integral part of students' learning experience. Models are especially useful in explaining phenomena that we can't actually see. Students should be given opportunities to be involved in the process of modeling especially of phenomena at the microscopic level. This present study focuses on student modeling at the microscopic level and also the dynamics of their model construction and reconstruction. This study would contribute to the research on microscopic modeling and hopefully contribute in providing a framework for helping students learn more effectively using models.

## **1.3 Rationale**

This section provides a detailed discussion of the rationale for this research work. I will discuss the motivation for conducting this research in light of the latest developments in science

and technology. I will also discuss the motivation for investigating microscopic modeling and for choosing friction as a context in which to examine the process of microscopic modeling by students.

### ***1.3.1 Why Now? – Relevance to New Scientific and Technological Breakthroughs***

We are currently at the verge of several breakthroughs in nanoscience and technology. Nanotechnology is a field hotly pursued by scientists and engineers who aim to develop nanoscale devices that can be controlled and manipulated at the atomic and molecular levels. In the next few decades, it is anticipated that machines will be built increasingly smaller, so small that thousands of these tiny machines (nanomachines) could fit into the period at the end of this sentence. In medicine for example nanomachines or nanoscale robots called nanorobots would soon be able to enter our bodies to detect defects, destroy cancer cells, repair damaged cells or deliver drugs to specific organs in our body. Clearly, nanotechnology has the potential to change the way we live. In the coming years, we need a scientifically informed citizenry that can actively participate in the decision-making processes concerning the social and ethical issues which have scientific aspects associated with them.

Recognizing the potential benefit of nanotechnology, the federal government has created the National Nanotechnology Initiative (NNI) to oversee research and development in nanotechnology from different agencies. One of the goals of NNI is the development of educational resources in advancing the teaching and learning of nanoscience and technology. Several of the initiatives of NNI are geared towards helping students of all ages learn more about nanoscience and technology.

There have also been several efforts develop curricular materials geared toward advancing nanoscience education in the elementary, secondary and undergraduate levels. The science education community has long recognized that curricular development without a solid research base on how students learn and build their understanding can often be fruitless. A lack of understanding of the impediments faced by learners can lead to instructional materials that may momentarily excite and impress students, but often fail to foster long-lasting understanding or learning. Therefore, I believe that an urgent need exists to fill the lacunae of research in the understanding and learning of phenomena at the nanoscale level by all students regardless of their future academic goals. This research can serve as an important building block in the

development of effective curricular materials and instructional strategies that can foster learning and understanding of phenomena at the nanoscale.

In the physics curriculum there are several potential topics where we can integrate discussion of phenomena at the atomic or nanoscale level. Friction, for example, is a topic which has implications at the nanoscale level. This study focuses on students' understanding of microscopic friction.

### ***1.3.2 Why Friction?***

In our day to day experience friction plays an important role. For example when walking we need friction between our feet and the ground. On the other hand, friction also has its adverse effects. Friction wastes about 20% of energy in your car's engine. By most estimates the economic cost of poor friction control is more than 6% of GNP which currently translates to about \$400 billion per year.

While friction is a well-known phenomenon at the macroscopic level, it is very poorly understood at the microscopic level, not just by students, but also by scientists. Nanotribologists are currently trying to understand the microscopic origin of friction. If nanotribologists succeed in understanding the nanoscale origin of friction then we will have a better way of manipulating surfaces so that we can nearly eliminate friction if desired. Microscopic engines and gears would soon be realities as microscopic circuits are today. Learning about microscopic friction will help students understand some of the key scientific issues underlying the promise of nanoscience and technology.

Friction is familiar concept that is a part of the daily life of students. Friction is also covered in high school and introductory college curricula. In the present high school and introductory college physics curriculum friction is presented at the macroscopic level. The study of macroscopic friction is consistent with the National Science Standards (Content Standard C, Physical Science), under the heading of "Motion and Forces".

Although microscopic friction has not yet been completely understood, recent studies indicate (Robbins and Ringlein, 2004) that friction at the atomic scale is quite different from macroscopic friction. This difference provides a useful context for exploring students' ideas and process of knowledge construction. These processes are the focus of this research. Although the

study of microscopic friction is not explicitly addressed in the National Science Standards it is indirectly linked to standards that cover “Structure and Properties of Matter”

### ***1.3.3 Why Modeling?***

Cognitive theories explain learning by focusing on changes in mental processes and knowledge structures that occur as a result of people’s efforts to make sense of the world (Eggen and Kauchak, 2004). To understand phenomena that are not directly experienced, learners typically use models.

McDermott and Redish (1999) have provided an excellent review of physics education research, most of which has focused on students’ misconceptions and difficulties in various topics. It is evident that there has been relatively little research investigating the dynamics of students’ construction and reconstruction of their mental models. It has been long known, however that learning is a dynamic process (Piaget, 1964; Vygotsky, 1978). Students construct and reconstruct their knowledge based on their previous knowledge and scaffolding afforded to them. I believe that instructors and curriculum designers will be in a better position to develop instructional strategies and materials that would help facilitate conceptual understanding among students if they know the fine-grained details of how student utilize different scaffolding and mental resources in their model construction and reconstruction.

In this research I have investigated the dynamics of students’ model construction and reconstruction in the context of microscopic friction. Based on the results of my research, I have developed instructional materials geared to help students develop appropriate mental models of microscopic friction. These materials are designed to improve students’ scientific modeling skills.

### ***1.3.4 Why Microscopic Modeling?***

As described earlier, there is a great challenge for science educators to integrate nanoscience education in the curriculum. Providing students the opportunity to do microscopic modeling in the classroom is a significant step in realizing this goal. Challenging students to think of what is happening at the atomic scale is a great step in advancing the goals of nanoscience education.

The complexity of microscopic processes requires us to use models in order to better understand and explain them. These models usually are structural and functional analogs of



familiar devices, processes or events. The use of microscopic modeling is potentially useful in different disciplines such as chemistry, physics, biology or engineering. To keep pace with the developments in nanoscience and technology, there is a need to teach these disciplines from microscopic view. With the advent of instruments such as the quartz crystal microbalance and atomic force microscope, nanotribologists are now starting to pin down the microscopic origins of friction. Several models have been proposed in order to explain the strange behavior of friction at the atomic level.

Thus learning about microscopic modeling would greatly help students become scientifically prepared for the 21<sup>st</sup> century. The work described in this dissertation focuses specifically on students' construction of microscopic models and the development of instructional materials that facilitates the construction of microscopic models.

#### **1.4 Broader Impacts**

The research completed by this project will inform the design of instructional materials that help students construct models of microscopic phenomena such as friction. Although there's no consensus model yet for microscopic friction, simplistic teaching models can be adopted in order to have a common terminology for explaining friction at the microscopic level.

By providing opportunities for students to do microscopic modeling of phenomena in their curriculum, they become better prepared for the required scientific knowledge in understanding modern technology, such as nanotechnology that will soon revolutionize their way of life. Learning about the science underlying modern technology will prepare students to be scientifically literate for the 21<sup>st</sup> century. A scientifically informed public that is knowledgeable about phenomena at the microscopic level, is better prepared to engage in important debates pertaining to the use of cutting-edge technologies that have the potential to impact the way we live.

#### **1.5 Research Questions**

This research project aims to address the following research questions:

- What are the variations in the existing models of introductory college physics students regarding microscopic friction?

- What scaffolding (cues, hints, activities and other external inputs) cause students to reorganize their knowledge about atomic friction?
- To what extent can they utilize this scaffolding to reorganize and reconstruct their models of atomic friction?
- What are the variations in students' interactions as they go through a series of model-building activities?
- What teaching interventions and/or instructional strategies can be designed to help students come up with a more scientifically accepted model of atomic friction?

## **1.6 Research Strategy Overview**

I investigated the aforementioned research questions from a cognitive-cum-social constructivist perspective. This perspective has greatly influenced me in identifying the research questions and also the methodologies. Consistent with this constructivist view, I believe that learning is a dynamic process where students construct and reconstruct new knowledge from previous knowledge through interactions with their environment, including social environment. From this perspective learning and conceptual change are facilitated through interactions with more capable individuals through systematic scaffolding, including carefully sequenced hands-on and minds-on experiences such as discrepant or consonant events.

I have adopted a research strategy that utilizes a multi-methodological approach encompassing three distinct phases. In the first phase of the study, I established the variations in students' mental models of microscopic friction through phenomenographic (Marton, 1986) analysis of clinical interviews with students. I also interviewed content experts and conducted a thorough survey of literature to understand the models that scientists typically used to explain microscopic friction. Keeping in view students naïve models and those used by experts, I arrived at a set of target ideas or models that I concluded were appropriate goals for student learning.

Students' pre-existing models and target ideas provided us an empirical basis for the second phase. I created a set of learning experiences that provided a context for investigating the dynamics of students' model construction and reconstruction. These learning experiences included scaffolding activities designed to facilitate student construction and reconstruction of their models regarding atomic friction. I conducted individual and group teaching interviews to determine students' learning trajectories and the dynamics of students' model construction and

reconstruction processes as they created a new model of friction at the atomic level while progressing through these learning experiences. The teaching interviews specifically made us aware how the scaffolding activities influence students' model construction and reconstruction. Moreover, the teaching interviews also allowed us to investigate the conceptual development of students as they go through the scaffolding activities.

The third phase of the research involved the development and validation of an instructional module and associated assessment tasks, based on my insights into students' learning trajectories. The module was geared towards helping students construct a scientific model of atomic friction. Scaffolding, based on results of the second phase which were found productive in helping students reconstruct their knowledge of microscopic friction was incorporated in the development of the instructional material. Student-material, student-student interactions were investigated by having several groups of students used the instructional module in a laboratory-like setting. Content validity of the instructional module and assessment tasks was established by having content experts critique the developed material. Table 1-1 shows the different phases of the research and the timeline.

**Table 1-1. Phases of the Research and Timeline**

PHASES	Timeline	
	Start Date	End Date
1. Establishment of Students' Pre- existing Mental Models of Atomic Friction (via Clinical Interview)	Spring 2003	Fall 2004
2. Design and Development of Teaching Activities to Help Improve Students' Models of Atomic Friction and Dynamics of Model Construction and Reconstruction (Teaching Interview)	Fall 2004	Summer 2005
III. Evaluation of the Designed Activities	Summer 2005	Fall 2005

### **1.7 Road Map of Thesis**

The dissertation consists of seven chapters. In the first chapter I discuss the underlying motivation for conducting the research, the context, its impact on science learning and teaching, and the research questions. Chapter 1 concludes with a description of the three phases of the research.

Chapter 2 provides a review of relevant research studies and literature which include the constructivist perspectives of learning and teaching, conceptual change, models & modeling, transfer and motivational aspect of learning. The chapter concludes with a discussion of the pedagogical, theoretical and research frameworks relevant to this project.

Chapter 3 discusses the research setting, research methodology, research tools and the philosophical and methodological perspectives that influenced the research design and analysis. It concludes with the presentation of the final research plan.

Chapter 4 presents the data gathering and analysis tools that were used in the first phase of the research which was an investigation of students' existing mental models of microscopic friction. The results of the investigation are presented and discussed in this chapter as well. Chapter 4 concludes with a discussion of the transition from the first phase to the second phase of the research.

Chapter 5 is a discussion of the data gathering and analysis tools employed in the second phase of the research. Results from the individual and teaching interviews are presented and discussed in this chapter.

Chapter 6 discusses the methodology and analytical tools used in the third phase of the research. The results of the development, evaluation & pilot testing of the instructional material on microscopic friction are also presented in this chapter.

Finally, Chapter 7 presents the key findings from the different phases of the research. It concludes with the discussion of the implications of the research for further study, curriculum material development and instruction.

## **CHAPTER 2 - Review of Related Literature & Studies**

### **2.1 Introduction**

This research is anchored primarily on the tenets of constructivism. In this chapter, I review the research literature related to constructivism. In line with this philosophical perspective, I also present a review of the literature and research on models, modeling, conceptual change and dynamic transfer. A section of this chapter discusses literature about friction at the atomic level which is the context in which the present study is anchored. The chapter concludes with a discussion of the pedagogical, theoretical and research frameworks relevant to this project.

### **2.2 Constructivist Perspectives of Learning and Teaching**

Two models of learning have been used in science classrooms - the behaviorist and constructivist models of learning. The behaviorist model of learning centers on changing students' external behaviors rather than their internal knowledge. According to Cohen (1987), "the central tenet of behaviorism is that thoughts, feelings, and intentions, mental processes all, do not determine what we do. Our behavior is the product of our conditioning. We are biological machines and do not consciously act; rather we react to stimuli." The version of behaviorism that is relevant to education is based on the theory of Skinner (1953) whose work was influenced by Watson (1912) and Pavlov (1927).

As per the behaviorist perspective the mind is seen as an empty vessel or *tabula rasa* to be filled in with information. The mind is a receptacle for storing ideas that come from experience. Behaviorists believe that the mind is not able to produce ideas of its own, rather it responds to proper conditioning. The primary role of the teacher in this model is to provide the proper conditioning that would change student behavior.

In contrast to the behaviorist model of learning, the constructivist learning theory proposed by Bruner (1966) and others, presupposes that students construct knowledge from external experiences and interactions with their environment. Learning occurs as the learners

construct new knowledge and skills as well as modify their existing knowledge and skills. The active construction of knowledge is significantly influenced by prior knowledge. As per this perspective the emphasis is on the process rather than on the product. The primary role of the teacher in this model is to facilitate learning rather than transmit it.

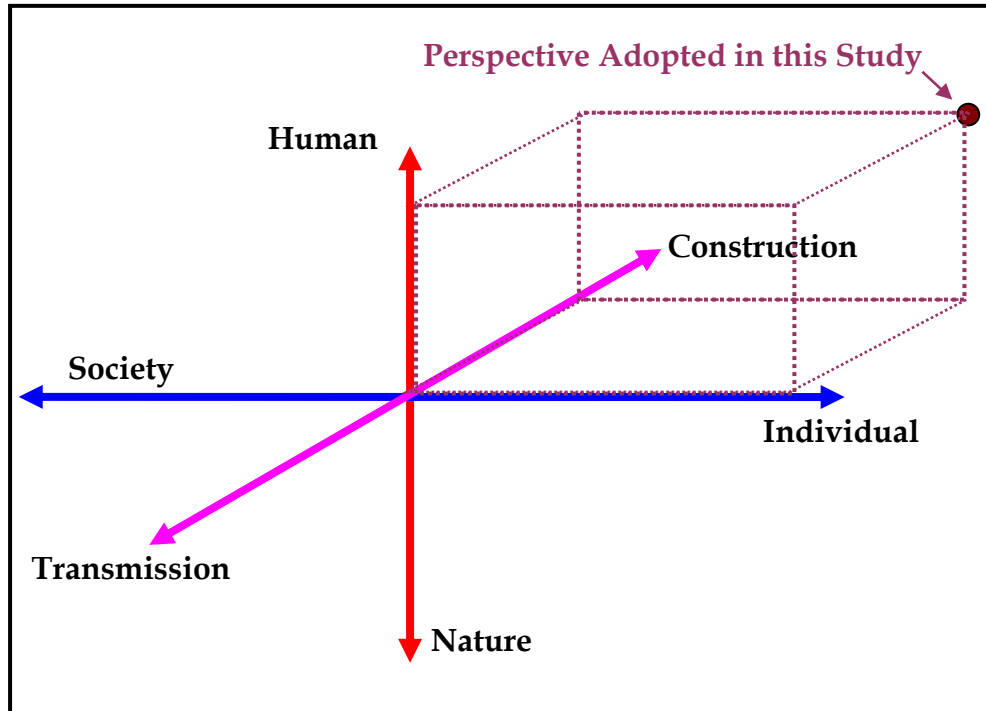
In describing the different facets of constructivism, Phillips (1995) proposed three dimensions (see Figure 2.1). The first dimension is concerned with the *ownership of the knowledge*. It is labeled “*individual psychology versus public discipline*”. At one extreme (individual) proponents focus on how individuals construct knowledge through their own cognition based on their interaction with their environment. Piaget (1964) and Vygotsky (1978) are both at this extreme although they see different mechanisms occurring as individuals construct knowledge. Piaget stressed the biological and psychological mechanisms to be found in the individual learner while Vygotsky focused on the social factors that affect learning. At the other extreme of this dimension, proponents are concerned about how human communities construct bodies of knowledge.

The second dimension is concerned with the *creation of new knowledge (human the creator versus nature the instructor)*. At one extreme, proponents posit that new knowledge is a human construct and does not exist outside the human mind. At the other extreme, proponents presuppose that knowledge is out there waiting to be absorbed by the learner in a relatively passive fashion.

The third dimension is concerned with the *process of learning*. This is the axis labeled *construction versus transmission*. At one extreme (transmission) is the spectator theory of learning. That is, the learner is passive and receives information, and without much mental or physical activity, internalizes it. It should be pointed out that this transmissionist view is not necessary identical to behaviorism discussed earlier. In transmissionist constructivism the learner may passively receive the information but nonetheless internalizes it in some way. Behaviorism on the other hand does not presuppose any internalization of knowledge by the learner, rather it focuses only on the change in behaviors. At the other end of this dimension (construction) learning is viewed as a dynamic process where learners are engaged in knowledge construction. Piaget and Vygotsky are both on this side of the scale for they both stress that the learner is mentally engaged in both the processes of construction and internalization. In the next

section I discuss the views of Piaget and Vygotsky in more detail and how they inform our research.

**Figure 2.1. Dimensions of constructivism and the perspective adopted in the study**



In terms of the three dimensions discussed above the present study is situated as shown in Figure 2.1. In terms of the ownership of knowledge dimension I am taking the perspective that learning is the construction of meaning by individuals from interaction and experiences with their environment. In terms of the second dimension (creation of knowledge) I am adopting the perspective that knowledge structures serve only to organize the learner’s experiential world and have no absolute correspondence with the natural world. In terms of the third dimension I subscribe to the perspective that knowledge is constructed through active engagement.

### ***2.2.1 Learning as seen by Piaget***

Three key elements are essential for learning as proposed by Piaget. One of the key ideas is the formation of *schemas*. Schemas are the components of an individual’s general knowledge structure that relate to that individual’s knowledge of the world Piaget (1964). They are organized systems of actions or thoughts that allow us to mentally represent or think about the objects and events in our world (Woolfolk, 2001). Bartlett (1932) considered schemas to be “maps or structures of knowledge stored in the long-term memory”. In the process of knowledge



acquisition or construction our pre-existing schemes often become inadequate that we are forced to adapt in order to function effectively. Adaptation is the process of adjusting schemes and experiences to each other to maintain equilibrium (Eggen and Kauchak, 2004). According to Piaget there are two basic processes involved in adaptation- *assimilation* and *accommodation*.

*Assimilation* occurs when we try to incorporate new knowledge into our pre-existing schema without reorganization of our previous mental structures. This process usually happens when differences between the new information and preexisting schema are not perceived or are ignored. Assimilation involves trying to understand something new by fitting it into or aligning it with what we already know. At times, we may have to distort the new information to make it fit (Woolfolk 2001). Disequilibrium occurs when we cannot assimilate new information into our existing schema. In order to fit in the new information we need to modify our pre-existing schema through a process called *accommodation* until the discrepancy is resolved (Bodner 1986). I will discuss these ideas further in the section on conceptual change.

This research focuses on the process by which students assimilate new ideas and modify their existing schema to accommodate new experiences. Through in-depth, think-aloud interview, I gain insights into how students negotiate these processes of conceptual change and the factors that mediate these processes.

Another theme central to Piaget's theory of learning is the idea of stages of cognitive development -- sensorimotor stage, pre-operational stage, concrete pre-operational stage, and formal operational stage. In the sensorimotor stage, intelligence is demonstrated through motor activity without the use of symbols. Knowledge of the world is limited, but constantly evolving because it is based on physical interactions and experiences. In the pre-operational stage, intelligence is demonstrated through the use of symbols. It is also at this stage that language use matures, memory and imagination are developed. However, thinking is done in a non-logical, nonreversible manner. In the concrete operational stage, intelligence is demonstrated through logical and systematic manipulation of symbols related to concrete objects. Finally, in the formal operational stage intelligence is demonstrated through the logical use of symbols related to abstract concepts.

It is important to point out that while Piaget primarily associated the above stages of intellectual development with an individual's age, most educators who use Piaget's ideas, such as Karplus (1974), have not necessarily associated these stages of development with the learner's

age. So, it is possible for a learner to be an adult and yet be a concrete operational thinker. It is also possible for a learner to function as a formal thinker in one domain, such as a domain in which one has developed a certain degree of expertise, while simultaneously functioning as a concrete operational thinker in a different domain in which he is a relatively novice learner. It is also possible that learners gradually acquire expertise and transition from being concrete thinkers to being formal thinkers in a given domain.

This research does not make any assumption that learners function in one mode or the other. Rather through the process of in-depth interviews we investigate students thinking without necessarily placing them in one of the above Piagetian categories of thinking. As I provide students experiences that help students construct mental models of microscopic friction, I also help them transition from being a concrete thinkers to more formal thinkers.

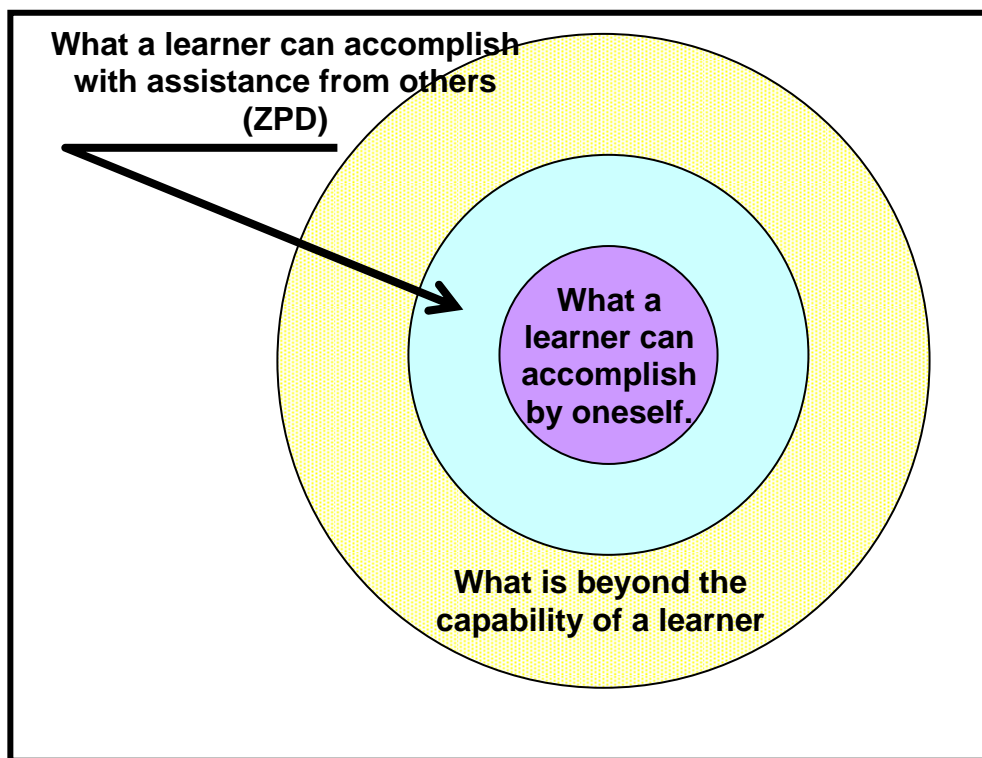
### ***2.2.2 Vygotsky and the Zone of Proximal Development***

According to Vygotsky (1978), learning and development arise directly from social interactions. One of the key concepts in his theory of learning and development is the notion of the Zone of Proximal Development (ZPD) which he defines as follows:

“Zone of Proximal Development is the distance between the actual development level as determined by independent problem solving and the level of potential development as determined through problem solving under adult guidance or in collaboration with more capable peers.”

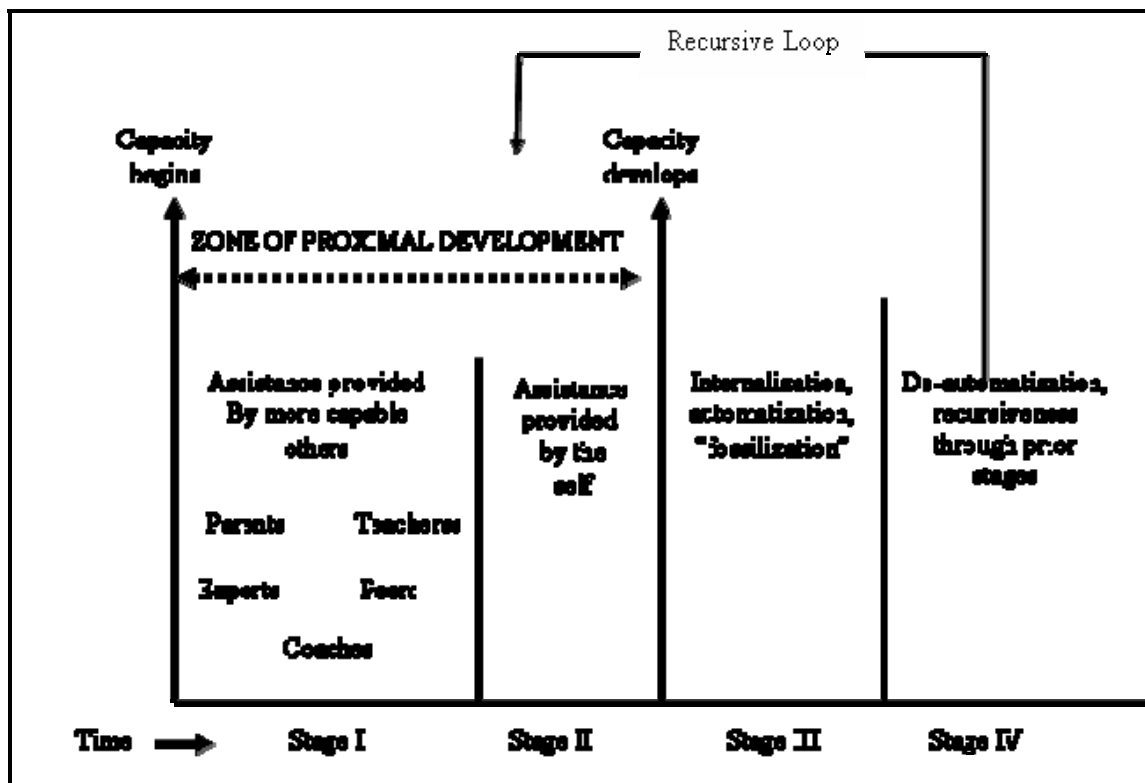
Simply put the ZPD is the cognitive “distance” between what an individual can accomplish on his/her own and what he/she can accomplish when assisted by more capable peers or adults. A useful mental visualization of ZPD is shown in Figure 2.2. If learners are within their ZPD, then they can learn the material (which is impossible for them to learn on their own) with assistance from peers or instructors. This structured and systematic assistance is referred to by Bruner (1966) as scaffolding. Just as workmen need scaffoldings as support in building or repairing a house, students need scaffoldings to support them in learning within their ZPD. A learner’s ZPD can be extended with scaffoldings from instructors, peers and learning materials (Bonk and Cunningham, 1998; Gredler, 1997; Bruner, 1984). The prompts, guidelines and questions that we provide students also serve as scaffolds (Bonk and Cunningham, 1998).

**Figure 2.2. Representation of a learner's Zone of Proximal Development (ZPD)**



Tharp and Gallimore (in McInerney and McInerney, 2002) identified four stages in the construction of knowledge involving the zone of proximal development as shown in Figure 2.3. In the first stage the learner is assisted by more capable persons (parents, teachers, experts and peers) in order to increase the proportion of his/her responsibility for and participation in the task. In the second stage a handover from the capable other to the learner has occurred and he/she can now perform the task unassisted although he/she is not expected yet to have mastered the task. Mastery of the task occurs on the third stage. In this stage the student internalizes what has been learned and practices to achieve automation. The fourth stage involves the de-automation of performance which leads to recursion back through the zone of proximal development. In this stage a task that a student could formerly perform is no longer possible, perhaps due to a change of context which leads to recursion to the first stage.

Figure 2.3. Tharp & Gallimore's Four Stage ZPD



The design of the teaching interviews that were conducted in the second phase of the research is primarily anchored on Vygotsky's idea of learning within the zone of proximal development via scaffolding activities. In this research, several scaffoldings (activities, prompts, guidelines and questions) were provided to students in order to extend their previous knowledge (which are not usually scientifically correct) about friction at the atomic level into one that is more scientifically accepted. The scaffolding activities and how these influenced students' knowledge construction and reconstruction are discussed in Chapter 5.

### 2.2.3 Integrating Piaget and Vygotsky

Each of the two theoretical perspectives discussed above brings with it a set of underlying assumptions about learning. Both perspectives highlight the importance of active learning. However, while the Vygotskian perspective focuses on activity within a socio-cultural context, the Piagetian perspective focuses on the learning of individual students through hands-on and minds-on activities. So, while Piagetian constructivists focus on learning in terms of cognitive

processes within an individual learner's mind, Vygotskian constructivists focus on an individual in action with others as the unit of analysis. A natural question that comes to mind when we amalgamate theoretical perspectives is whether each of them contain features that are mutually exclusive or contradictory with respect to the other.

The combination of the socio-cultural (Vygotskian) and cognitive (Piagetian) perspectives has been considered before and is not new. Cobb (2005) discusses the notion of "theoretical pragmatism" where he combines elements of the two perspectives in ways that are not mutually exclusive. Cobb points out that although the construction of knowledge by the learner may be attributed to different kinds of activities – socio-cultural vs. sensory-motor and conceptual, the knowledge constructed through these different kinds of activities must eventually be internalized by the learner. He therefore argues that the two perspectives are not mutually exclusive. He further purports that each perspective brings its own value in examining learning. While the socio-cultural perspective focuses on the "conditions for the possibility of learning," the cognitive perspective focuses on "what students learn and the processes by which they do so." Thus Cobb argues that each perspective "constitutes a background for the other." It is in this spirit that the two perspectives have been amalgamated in this research.

## 2.3 Conceptual Change

One type of research that relates to conceptual change deals with identifying students' alternative conceptions. Another type of research in this area is geared towards facilitating conceptual change among students in the classroom. It is beyond the scope of this thesis to provide a comprehensive overview of the research in the area of conceptual change. In this section I will present examples of these studies that are most relevant to my research.

Much of the work done on conceptual change pedagogy is anchored on Piaget's model of personal constructivism. These conceptual change strategies start by understanding what students know and then proceeding to providing educational experiences to students in order to challenge these prior ideas and thus lead them to consider alternative ideas and eventually reconstruct their knowledge in a way that is more consistent with ideas that are the prevailing scientific view in the field. Cognitive conflict or dissonance (Festinger, 1957) strategies make students dissatisfied with their existing conception and thus make them more amenable to consider alternative views. The dissatisfaction according to Posner (1982) would drive students to reconstruct their ideas. In this research, I integrated cognitive conflict-based activities to scaffold the students' knowledge construction and reconstruction.

Earlier research in science education (Novak, 1977; Driver and Easley, 1978; Viennot, 1979; McCloskey, 1983) had established that students bring to the classroom alternative frameworks, preconceptions, or misconceptions that are robust and difficult to change through traditional teaching. Misconceptions can be the result of instruction or they may originate prior to instruction (Vosniadou 2002). Researchers Chi and Roscoe (2002), Hewson (1981) and Posner (1982) agree that students often have some naïve knowledge or prior conceptions in the domain. McDermott and Redish (1999) have provided an excellent review of physics education research, most of which has focused on students' misconceptions and difficulties in various topics. It is apparent from this review that there has been significant emphasis on investigating students' difficulties in developing a robust conceptual understanding in various topical areas of physics. However, there is considerably less emphasis placed on students' construction of knowledge structures or mental models which is one of the foci of this research.

To facilitate conceptual change in the classroom, researchers (Cosgrove and Osborne, 1985; Gunstone, Champagne et al., 1981; Chinn and Brewer, 1993) propose the use of cognitive

conflict-based conceptual change instructional models. Conceptual change is hoped to occur by engaging students to do the following tasks: establishing prior ideas, providing cognitive conflict activities, resolving the conflict, and recognizing the modified idea. Park (2006) proposes that in the conflict-resolution stage students can be engaged to do similarity-based reasoning. In the similarity-based reasoning model, one tries to map out similarities between pieces of knowledge in one's background knowledge space with the pieces of information generated out of a target experiment. This view is consistent with the dynamic transfer framework that we use in this research.

More recently, several researchers (Vosniadou and Brewer, 1992; Vosniadou 1994; Ioannides and Vosniadou, in press; Vosniadou & Tiberghien, 1997; Kouka, Vosniadou et al., 2001) have attempted to provide detailed descriptions of the development of knowledge in specific subject matter areas (e.g. the physical sciences) Results of the study conducted by Vosniadou and Brewer (1992) on students' mental models, show that in the process of learning science, children add or delete beliefs and presuppositions to their explanatory frameworks destroying their coherence, while at the same time distorting the scientific concepts to which they are exposed. Vosniadou advocated the "framework theory" to refer to the conceptual system that young children form to interpret their observations about the physical world. This framework is believed to consist of certain basic ontological and epistemological presuppositions about the nature of physical objects and the way they function in the physical world. In their study Vosniadou and co-workers identified ontological presuppositions such as: physical objects are solid and stable, space is organized in terms of the directions of up and down and that unsupported objects fall in a downward direction. They likewise identified epistemological presuppositions by children in their study -- rest is the natural state of inanimate objects and motion needs to be explained, and that entities such as force, heat and weight are properties of physical objects. Children's observations and information received are interpreted under the constraints of such presuppositions. This view too is consistent with our framework on dynamic transfer in that our framework attempts to identify the epistemological, motivational and other factors that control what learners notice about their new situation as well as the prior knowledge that they bring to bear as they make sense of their new situation.

According to Chi (1992) and Reiner et al. (2000) misconceptions arise when a person associates the wrong ontology with a scientific concept such as force or heat. For example, Chi

notes that many concepts in physics are wrongly associated with a substance ontology when in fact they belong to a process ontology. Moreover, Chi believes that the process of changing theory exclusively involves ontological change. In other words, to address learners' misconceptions we must rectify the inappropriate ontological classification that they associate with a given object or phenomena. For instance, as Wittmann, Steinberg et al. (2002) propose, a learner may think of a wave as an object and associate several inappropriate features with it, while a different ontology, such as wave being classified as an event or phenomenon might enable the learner to associate scientifically correct features with a wave. Unlike Chi, Vosniadou (1994) argues that since we are dealing with complex knowledge system (consisting of a network of beliefs or presuppositions) conceptual change does not happen suddenly but is a gradual process and takes a long time to achieve. Thus, to facilitate conceptual change, it is not sufficient to address a learners' ontology.

Posner (1982) attempted to study why students maintain their existing conceptions in spite of instruction, and under what conditions these conceptions change. The following ideas were identified to be essential in promoting conceptual change:

- Students are dissatisfied with previous ideas.
- Students find the new conceptions are intelligible and make sense.
- Students perceive the new idea to be plausible.
- Students find the new conceptions are open to new areas of inquiry.

On the other hand, studies had likewise shown that cognitive conflict doesn't necessarily lead to conceptual change (Chan, C., J. Burtis, et al., 1997; Chinn and Brewer, 1993; Dole & Sinatra, 1998; Limon & Carettero, 1997; Posner, Strike et.al, 1982). Students' conceptions are highly resistant to change when students' knowledge structures are crystallized, coherent and firmly entrenched, even when faced with data that conflict with the existing ideas. In this research I explore multiple ways in which to help learners acquire new ideas about microscopic friction. These include the use of discrepant events, and also the use of activities and experiences that help the student generate alternative models to explain the discrepant event.

In describing the development of students' intuitive knowledge in physics diSessa (1993) proposes the theory of "knowledge in pieces". diSessa's theory is based on hypothetical knowledge structures called phenomenological primitives or p-prims. P-prims are small (atomic elements) or simple knowledge elements which are essentially always evoked as a whole. In



other words, p-prims are the smallest possible units of reasoning. The term phenomenological is used to describe these units of reasoning because they are created and reinforced by students' experiences with concrete phenomena, rather than through abstract reasoning. diSessa has shown that students activate certain p-prims in constructing their ideas. The following are some basic p-prims:

*Ohm's P-prim:* A tri-particle element with an impetus (effort), a resistance, and a result. Ohm's p-prim entails the following expectations: More effort begets more result; more resistance begets less result.

*Force as a Mover:* An abstraction of a push or toss. Things go in the direction you push them.

*Dying away:* Induced motion just dies away, like the sound of a struck bell

diSessa emphasizes that p-prims, per se are neither correct nor incorrect. Rather they are activated correctly or incorrectly depending upon the context. For instance, in most real-world scenarios the 'Force as a Mover' p-prim can help a learner predict situations correctly. However, in an ideal, frictionless situation applying this p-prim can lead to incorrect predictions of motion by the learner.

While p-prims are the represent knowledge elements of the smallest possible grain size, diSessa has proposed another knowledge structure that is at the other end of the spectrum of grain size. This knowledge structure according to diSessa is the coordination class. A coordination class, unlike p-prims is large, complex systems which are intended to constitute a model of a certain type of scientific concepts. It involves "systematically connected ways of getting information from the world" (diSessa and Sherin, 1998)

Coordination class consists of two distinct elements: Readout strategies and causal nets. Readout strategies are the set of methods by which any relevant information is gleaned from the world and causal nets are the collection of possible inferences that can be drawn from available information (diSessa in Limon and Mason, 2002 p.44).

DiSessa and Wagner (2005) identify two possible causes of difficulties in the development of coordination class.-- *span* and *alignment*. *Span* pertains to breadth of knowledge that one possesses in order to "operate" a concept across different contexts in which the concept is applicable. For instance, a learner who initially could apply the concept of friction in the

macroscopic domain, but is now able to apply it in the microscopic domain as well is said to have increased her *span* of the co-ordination class of friction.

*Alignment* on the other hand pertains to reading out the same information from a variety of context no matter what readout strategies and inferences are used. An example of increasing *alignment* would be that of a learner who initially recognized friction only as the force between two surfaces rubbing against each other, but now correctly recognizes that friction is no different than the force of “static” when two pieces of charge clothing stick together.

According to diSessa and Wagner (2005) two processes are involved in constructing coordination class- incorporation and displacement. *Incorporation* is the process of “recruiting elements of prior conceptualization into partial encoding of the new concept.” This process occurs when learners make associations between their newly developing coordination class and prior knowledge. So, for instance a learner when developing a coordination class concept for friction might begin to associate friction with electrical interactions, a concept that they had learned previously and is stored in their long-term memory.

*Displacement* is the process of dismissing elements of prior conceptualization that may initially and inappropriately “take over” consideration of particular circumstances from a coordination class. An example of this process might occur when a learner who initially associated increasing smoothness with decreasing friction between two surfaces realizes that in fact increasing smoothness can also be associated with increasing friction, has just displaced her initial associations and replaced them with new ones.

In this research, I have not characterized students’ ideas about microscopic friction in terms of a co-ordination class *per se*. However, I believe that several features of coordination classes such as span and alignment and the processes of incorporation and displacement are relevant to the criteria we can use to examine the robustness of students’ models of microscopic friction.

Hunt and Minstrell (1993) introduced the idea of *facets* which are individual pieces or constructions of a few pieces of knowledge and/or strategies of reasoning that are activated by learners in making sense of a situation. They have documented different facets of students’ thinking. Facets are larger in grain size than p-prims but are certainly smaller than coordination classes. Unlike p-prims, which are not necessarily tied to a particular context, facets are p-prims activated within a given context. An illustrative example demonstrating the difference between

p-prims and facets is described by Redish (2004). For instance, ‘closer is stronger’ is a p-prim. However, when this reasoning is applied to explaining seasons on the Earth in terms of its proximity to the Sun, the p-prim manifests itself in the form of a facet.

In my research I have noticed the use of intuitive knowledge by students which can possibly be traced back to their everyday experiences. Because the scope of our study is relatively narrow, it is difficult for us to characterize this intuitive reasoning as p-prims per se, however, because I have examined reasoning only within the context of microscopic friction it would be more accurate in referring to some of the intuitive student reasoning in terms of a facet rather than a p-prim.

While p-prims and facets are knowledge structures of relatively small grain size, other researchers have modeled student knowledge in terms of larger knowledge structures such as misconceptions or pre-conceptions. Chi and Roscoe (2002) distinguish between two types of naïve knowledge- pre-conceptions and misconceptions. Preconceptions are the naïve knowledge that can be readily revised or removed via instruction. Misconceptions on the other hand, are those kinds of naïve knowledge elements that are robust and are highly resistant to change even after ingenious instruction. Chi and Roscoe propose two levels at which preconceptions can be viewed – the proposition level and the mental model level.

According to Chi and Roscoe, a system of knowledge can be evaluated at the level of single ideas that can be stated as sentence or “propositions”. Propositions are beliefs that can either be incorrect or correct. At the mental model level, knowledge is represented as a set of interrelated propositions. Mental models can be judged according to coherence. Mental models in which the propositions are not interconnected in some systematic way are referred to as fragmented or incoherent models. On the other hand, a coherent model consists of propositions that are interconnected in an organized manner. Such knowledge representations can be used to make predictions and generate explanations in a consistent and systematic way. In my research I examine student creation of models. However, unlike Chi and Roscoe I deliberately adopt a value neutral stance and refrain from focusing on the scientific correctness of a student’s model. Rather, I focus on the process through which these models are created.

According to Chi and Roscoe, misconceptions occur as a result of assigning a concept in the wrong ontological category (Chi & Roscoe, 2002). This perspective implies that conceptual change involves the realignment or shifts across ontological categories. According to these

authors conceptual change is difficult for the following reasons -- students lack awareness of their understanding, or they lack an alternative category to shift concepts into, which they refer to an emergent process category. It is the lack of an emergent process category which makes conceptual change rather difficult. One can address the issue effectively and efficiently by providing students with the missing emergent process category to facilitate conceptual change. Thus Chi and Roscoe appear to be proposing an incremental model of conceptual change – one in which a learner is promoted through a sequence of emergent process categories. This notion is consistent with our design of model-building experiences in our researcher to facilitate students' creation of a mental model of microscopic friction.

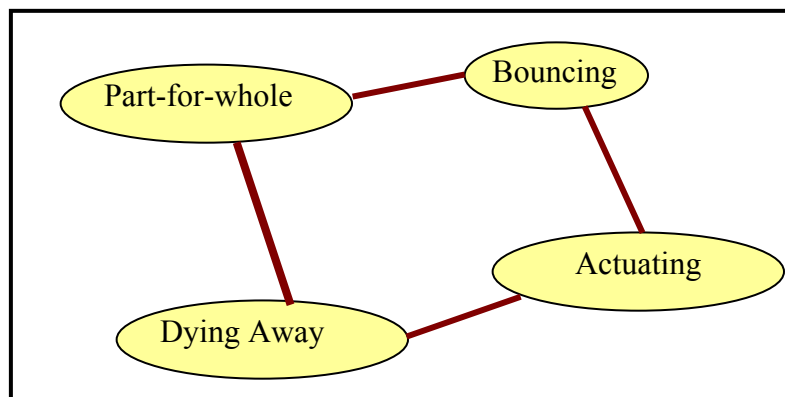
Along the lines of this incremental approach, other researchers have also proposed several different methods of conceptual change. Thagard (1990) proposes two processes for conceptual change -- branch jumping and tree switching. In branch-jumping one shifts a concept from one branch of a hierarchical tree to another. Tree-switching involves changing the organizing principle of a class of concepts. Hammer (2000) proposes the idea that learners put together conceptual resources in understanding physical phenomena and concepts. Conceptual resources are small grain size mental structures which can be thought of as “a unit of mind-code” (Hammer, 2002). It is likened to chunks of computer codes that can be incorporated into programs to perform some function. The resources as opposed to p-prims are not just phenomenological but can be epistemological and procedural. Thus resources can be larger in grain size than p-prims or facets. However, based on Hammer's analogy of mind code, I believe that resources are typically smaller in grain size than say diSessa's (1998) coordination classes or Johnson-Laird's (1983) mental models discussed later.

It is important to point out that Hammer's view of resource activation as a conceptual change process, is in some ways different from other conceptual change processes in that it does not focus on negating or correcting incorrect conceptions that are based on a learner's raw intuition. Rather it focuses on strategies to facilitate a learner's refining of their raw intuition. The process of refinement can involve activation and suppression of appropriate resources (Hammer and Elby, 2002)

Wittmann (in press) proposes the use of a resource graph in depicting how conceptual change occurs. The resource graph is a means to represent the resources that are activated/primed in a given situation or context. Figure 2.4 shows an example of a resource graph. Each circle

represents a resource and the lines show the links between/among resources. One of the limitations of the representation as acknowledged by the author is its static nature.

**Figure 2.4. Resource Graph**



Using resource graphs, Wittmann has attempted to describe four types of conceptual change – incremental, cascade, wholesale and dual construction. In incremental change, resources are either being added or deleted. This process is similar to Piaget’s idea of assimilation. Cascade involves connected changes to a resource graph. In a wholesale change, the final resource graph is totally different from the original resource graph. This process is similar to Piaget’s idea of accommodation. Finally, in dual construction, learners construct another resource graph in addition to the previous resource graph they have. The latter notion is consistent with a student being in what Bao and Redish (2000) might call a ‘mixed model state’ i.e. the student has two conceptions and activates different conceptions in different contexts.

Table 2-1 shows examples of resource graphs that depict each type of conceptual change.

In documenting student’s knowledge construction and reconstruction in the context of microscopic friction, I will be using resource graphs similar to the one proposed by Wittmann. However, unlike Wittmann’s representation, which does not depict the actuating agent that triggers conceptual change, our representation attempts to depict the factors that trigger conceptual change based on our experimental evidence.

The list of processes of conceptual change enumerated by Wittmann above can be expanded to include yet another process that Fauconnier and Turner (2002) refer to as “conceptual blending” or “conceptual integration.” Blending is a way of combining “mental

spaces.” A mental space is a set of assembled knowledge elements: .e.g. the scenario of a pair of wood blocks (say block A and B) sliding on each other is a mental space that ‘contains’ information about each block and how they interact.

In comparing blending with the conceptual change processes described by Wittmann (in press), I in fact find that blending is the reverse of the ‘dual construction’ process described by Wittmann.

In the blending process the learner selectively combines features from two “mental spaces” called “input spaces” into a single space called the “blended space”. An example of blending would be a learner combining her mental space of wooden blocks A and B with another mental space of a pair of metal blocks X and Y sliding on each other. The blending of these two input spaces could yield a blended space in which wooden block A is sliding on metal block Y. So the learner has selectively combined aspects of the two mental spaces to create a new space in this case hypothetical scenario i.e. a blended space.

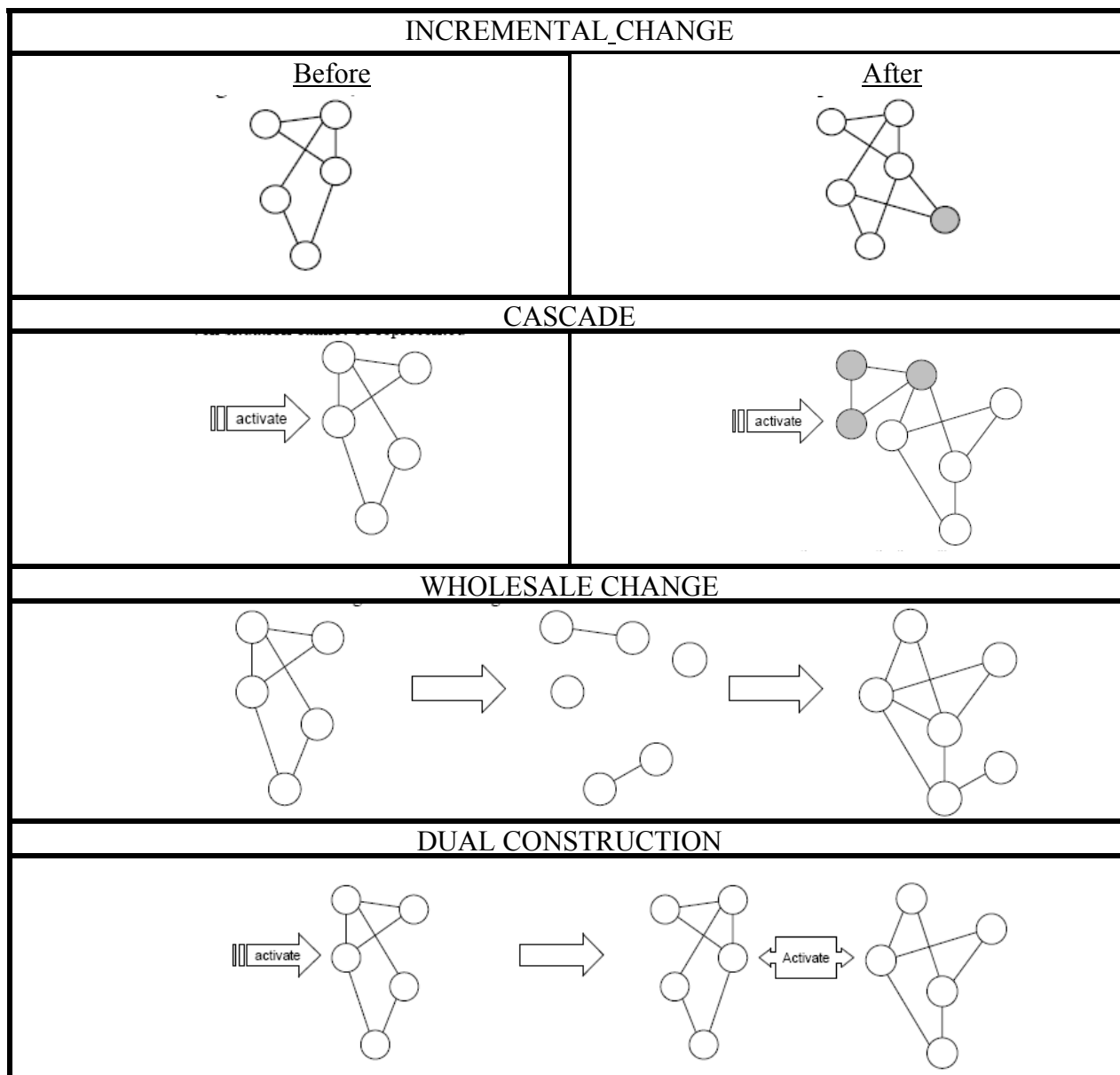
Fauconnier and Turner (2002) describe blending as a cognitive process that is deeply entrenched in our everyday thinking. We engage in ‘blending’ intuitively without any conscious effort. The blended space produced as a result of this process may selectively contain features of each of the input spaces, but it provides an effective cognitive ‘sand box’ for playing with ideas and making predictions, which are impossible with either of the two input spaces. For instance, in the example above, by creating the blended space of wooden block A sliding on metal block Y, the learner might be able to predict how the two blocks interact and generalize this knowledge to interactions between wood and metal, something that would be impossible in either of the two input spaces.

The notions of conceptual blending are in many ways similar to the ideas of ‘hybridization’ described by Hrepic (2002). In his study on students’ models of sound propagation Hrepic found that students quite often tended to combine aspects of the scientifically accepted ‘wave’ model and a more naïve ‘entity’ model. The ‘hybridized’ model contained selective features of the wave and entity models some of which were mutually contradictory features of each. Hrepic found that students would then use this hybridized wave entity model to make predictions about sound propagation in several real-life situations.

I find that the paradigm of ‘conceptual blending’ can provide a useful way of examining conceptual change especially in the context of student modeling of microscopic phenomena that

they cannot see, and can only imagine. Thus, students are left with no recourse but to blend aspects of their models of macroscopic reality with that of certain aspects of the microscopic nature of particles that they may be aware of to create a blended mental space that allows them to explain and predict microscopic physical phenomena.

**Table 2-1: Wittmann's processes of conceptual change**



## 2.4 Models and modeling

In this section I will be discuss the different definitions of mental models used by various researchers. Based on these various definitions, I will construct a functional definition of a mental model that I use in my study. The section concludes with a discussion of the role of analogical reasoning in the process of student's construction/reconstruction of knowledge.

### 2.4.1 Models Defined

The study of students' mental models has been, and continues to be a hot topic of research in cognitive psychology and science education. Mental models according to Johnson-Laird (1983) "are structural analogues of the world as perceived or conceptualized." Meanwhile, Gentner and Stevens (1983) argue that "mental models are related to human knowledge of the world and of how it works i.e., the way people understand some domain of knowledge." From Gilbert and Boulter's (1998) perspective, a model is a "representation of a target which might be an object, event, process or system." Vosniadou (1994) believes that "mental models refer to a special kind of mental representation, an analog representation, which individuals generate during cognitive functioning."

Driver (1986), Glasersfeld (1989) and Redish (1994) describe students' mental models as ways in which learners organize experiences to minimize the mental energy needed to make sense of the world around them. Learners often test the adequacy of these models in the light of new experiences, thereby constantly modifying and reorganizing them. Thus, at any point in a learner's development, these models may involve multiple representations, myriad rules and procedures that the learner may not even know how to apply. Furthermore, these models may be nebulous, incomplete or self-contradictory. During instruction, students build on and modify these mental models. Depending upon the complexity of the model, this change can be a long and difficult process for the learner. Greca and Moreira (2002) define mental model as an internal representation which acts out as a structural analogue of situations or processes. Its role is to account for the individual's reasoning both when he/she tries to understand, tries to predict and explain the physical world.

In this research mental model is my own representation of what I believe students think of a certain physical phenomenon — friction. I believe that students construct these models *in vivo* while answering questions during an interview -- predicting and explaining why a system

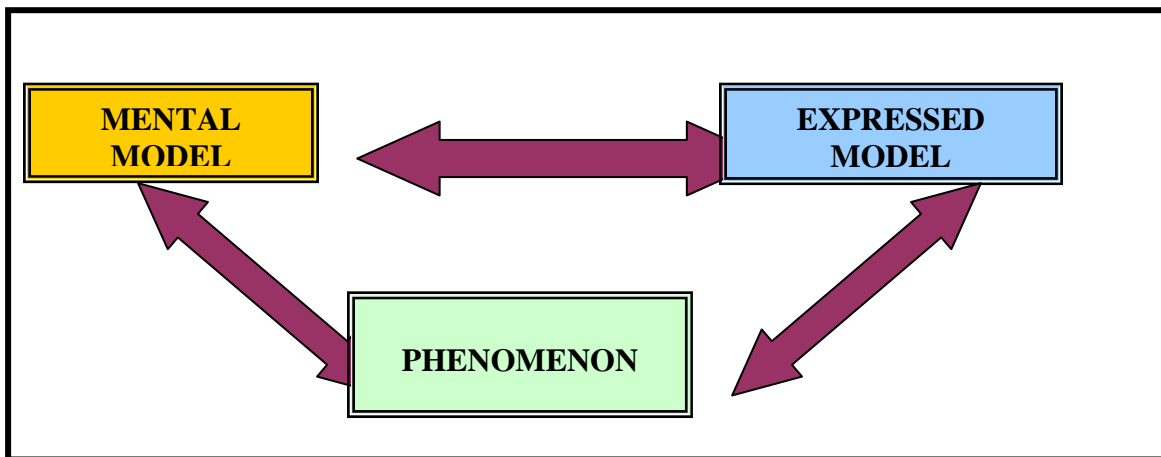


behaves in a particular way in a given context. The term ‘mental model,’ in my research, actually refers to the model that I, the researcher have constructed to describe what I believe the students are thinking.

In talking about mental models we can not avoid the fact they seem to be private in nature (Gilbert and Boulter, 1998; Franco and Colinvaux, 2000; Norman, 1983). How then can we access somebody else’s mental model? Gilbert and Boulter (1998) suggest that we can rely on the expressed version of it which they term expressed models. Expressed models are believed to represent selected aspects of phenomena and of our mental models. Figure 2.5 shows the interactive nature of relationship between models and phenomena (Buckley and Boulter, 2000).

To discover the students’ mental models in this study regarding friction I conducted semi-structured clinical interviews and asked students factual and generative questions (Vosniadou, 1994) in various contexts. Several activities were presented to the students where they were asked to predict and explain what they thought was happening.

**Figure 2.5: Interactive relationship between models and phenomena**



The different activities provided me different contexts in which I probed deeper into students’ understanding, and thus had a better access to their thinking. This also put us in a better position to assume that the students’ expressed models are close representations of their mental models. In our final analysis, the categories of students’ responses (mental models) from our interview data were examined by taking into account the aforementioned features of mental models.

### ***2.4.2 What Model Means in This Study***

In this research, I am subscribe to Greca's & Moreira's idea that a mental model is an internal representation which acts out as a structural analogue of situations or processes which can be accessed through some expressed versions of it (Gilbert and Boulter, 1998).

I am cognizant of the issue raised by Norman (1983) that one should distinguish between an individual's mental models and the analysis that researchers carry out regarding these models. However, I couldn't disagree more with this issue of grasping or understanding students' mental models. In my research when referring to students' mental models I actually refer to my own model of students' understanding that is gleaned from students' expressed model.

Like many other things that physicists try to describe, such as microscopic particles, we can never see or 'read' what is in a student's mind, but we can (like physicists often do) construct a model (based on experimental evidence) about what or how a student might be thinking based on what they tell us. Why do we researchers build models of student thinking? For reasons similar to why physicists do. Such models, similar to models in physics can be useful, because they provide us with a vocabulary or framework to describe what a student may be thinking, and what difficulties he or she is experiencing while making sense of the situation. Based on our models of what the students think of a particular phenomena instructors and curriculum designers can be in a better position to create interventions that will help students reorganize pieces of their knowledge and eventually improve their existing mental model so as to have a deeper and more coherent understanding of a given phenomena.

### ***2.4.3 Analogical Reasoning***

One of the mechanisms of transfer with which this research will be primarily concerned is analogical reasoning. Ample evidence (Hamed, 1999; Reed, Ernst et al., 1974; Hoffding, 1892) indicate that analogical reasoning, which is often an underlying cognitive process in the construction of students' understanding, can be very useful. Students often grasp abstract ideas by mapping them onto more concrete ones (Lave and Wenger, 1991). Students have been found to use analogical reasoning as early as 5th grade (Clement, 1998). However, researchers have pointed out that learners must recognize the limits of analogies and the difference between analogies and reality to prevent "over-mapping" the analogies (Kurtz, Miao et al., 2001).

Research conducted by Hamed (1999) demonstrates students' spontaneous use of analogies while explaining surface phenomena at the microscopic level. He found that student-generated analogies could either be static (describing an object) or dynamic (describing an event). Obviously, both transfer and analogical reasoning are very relevant in students' knowledge construction/reconstruction which is one of the foci of this research.

#### ***2.4.4. Microscopic Modeling***

Numerous studies (Abraham, Grzybowski et al., 1992; Griffiths & Perston, 1992; Hesse and Anderson, 1992; Andersson, 1990; Unal, 1996) have been conducted to document students' ideas about particles and atoms. Relatively fewer studies (Eylon and Ganiel, 1990; Lee, Eichinger et al., 1993) have been completed to investigate students' use of models in explaining the behavior of bulk matter.

Hamed (1999) conducted an investigation of how students think about surface phenomena (i.e. oil drop in water, paint on a metal, sticking mechanism of tapes etc.) One of his findings was that physics majors have no predisposition of using microscopic explanations in describing and explaining macroscopic phenomena. They usually only gave such explanations if they were asked or cued to explain a phenomenon at the microscopic level. Hamed also found out that when students are presented with novel situations, they usually use analogies to describe and explain the phenomena. In most instances the students used a mesoscopic model in order to explain a phenomenon at the microscopic level. For example when asked to explain the sticking mechanism of a tape at the microscopic level one student answered:

*“...I can visualize little fingers reaching out and grabbing. But I'm not sure that this is what is happening because molecules are not little fingers”.*

Mikelskis-Seifert and Fischler (2003) contend that the transfer of macroscopic attributes to the submicroscopic objects is the central problem of learning about particles and atoms. These researchers claim that the major teaching problem is the difficulty in achieving an acceptable understanding of the particle world. That is, the understanding that most of the macroscopic properties of matter with which we are so familiar, are lacking in the submicroscopic world. As a consequence teachers should more strongly emphasize the differences that exist between the scientist's understanding of the material model and the model world presented to students. Moreover, Mikelskis-Seifert and Fischler found out in their study that students who are able to

differentiate between these two worlds and are aware of their specific characteristics have achieved a metaconceptual awareness that helps them overcome misconceptions about the micro-world.

Research conducted by Anderson (1990) and Mikelskis-Seifert and Fischler (2003) had shown that students' transition into the microworld is dominated by macroscopic thinking. However, in the study by Mikelskis-Seifert and Fischler (2003), a teaching unit was developed on the basis of a framework called the 'Level System of Multiple Representation,' in order to improve students' understanding of the basic ideas of the particle model. Results showed that students who were exposed to the teaching unit had a significantly higher increase in their pretest to posttest scores. The framework used by Mikelskis-Seifert was useful as I designed the learning experiences for our students to help them construct a model of microscopic friction and will be discussed later in this chapter.

Based on the review of literature, it is clear that there are very few studies that have been completed so far that document the use of microscopic models in explaining physical phenomena. A study has yet to be completed to document what students think about friction and lubrication at the atomic level. One purpose of the present study is to document students' models of microscopic friction which likewise will provide benchmark for further investigating the dynamics of their model construction/reconstruction in the context of microscopic friction. Moreover, scaffolding activities were designed to help students acquire a metaconceptual awareness of the different mechanisms of macroscopic and microscopic friction.

## **2.5 Microscopic Friction**

This section starts out with the discussion of the early models used to explain friction and their corresponding limitations. Then, I proceed to a discussion of contemporary models of explaining friction. Finally, I discuss experts' views about friction at the microscopic level, which is still an emerging area of research.

### ***2.5.1 Coulombs Interlocking Model***

The first systematic study of friction was conducted by Leonardo da Vinci. He was the first to propose the following ideas about friction, commonly referred to as Amonton's Laws of Friction:

- Friction produced by the same weight will be of equal resistance at the beginning of its movement although the contact may be of different breadth and length.
- Friction produces double the amount of effort if the weight doubled.

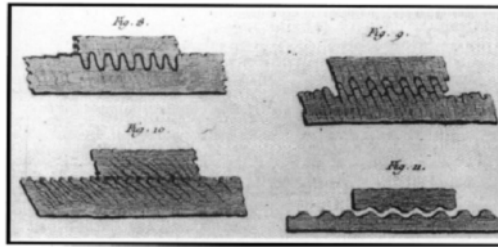
Another physicist who acquired an interest in studying friction is Charles Augustin Coulomb. He investigated how the following factors affected friction:

- The nature of the materials in contact and their surface coatings
- The extent of the surface area.
- The normal pressure (or force)
- The length of time that the surfaces remained in stationary contact.
- Ambient conditions such as temperature, humidity and even vacuum.

In explaining the cause of friction, Coulomb proposed the interlocking model as depicted in Figure 2.6. According to this model friction arises from mechanical interlocking between rigid or elastically deforming asperities. This model can explain the fact that the coefficient of dry sliding friction is between 0.1 and 1.0 for many pairs of materials.

There are two identified limitations for such a model in explaining friction. First, it does not provide guidance on how to calculate the average angle of the saw tooth planes and how that angle would depend on the gross roughness of the surfaces or on the type of material. For instance, the friction between very smooth surfaces can be extremely large (Swartz and Miner 1997). Secondly, it can not explain why friction produces energy loss. In the above model, energy is recovered when the block slides down into the next position of the saw tooth geometry. Clearly, this model can not explain cold-welding of two highly polished metal surfaces.

**Figure 2.6: The Interlocking Model**



### 2.5.2 Molecular Adhesion Model

Bowden and Tabor (1950) in their book *The friction and lubrication of solids* presented a simple model for friction on a micrometer scale- the adhesion model or plastic junction model. This model assumes that friction is proportional to both the real area of contact and a mean lateral force per unit area, the so-called shear strength. The friction force is given by

$$\text{Friction Force} = AS \quad (2.1)$$

Where:

S is the force per unit area to shear a junction

A is the actual contact area

in this model, the actual area of contact is proportional to the load and is given by

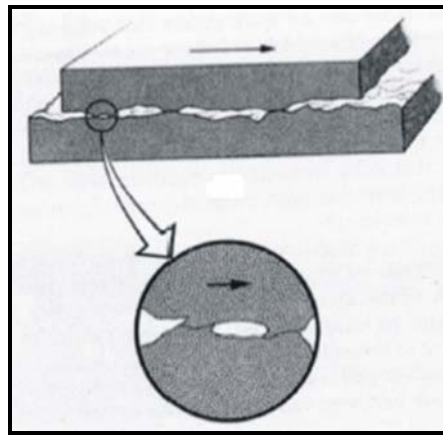
$$A = \frac{\text{Normal Force}}{\text{Yield Pressure}} = \frac{N}{P} \quad (2.2)$$

For most materials the shear modulus is about  $\frac{1}{2}$  the compression modulus, it is plausible that the friction force should be about  $\frac{1}{2}$  the normal force:

$$F = \frac{N}{P} S \Rightarrow N \frac{S}{P} \approx \frac{1}{2} N \quad (2.3)$$

In the adhesion model dry sliding friction is caused by the breaking of large number of tiny spot welds that are continually made as two objects are pressed together and slide over each other as depicted in Figure 2.7. The energy loss in the friction mechanism is described as plastic deformation of the asperities. Thus, it is called the plastic junction model. Thus, the understanding of friction at the micrometer scale has been reduced to an understanding of two new quantities: shear strength and area of contact. However, one of the limitations of the above model is that it can't explain the coefficient of friction  $\mu$  for ductile materials.

**Figure 2.7: Spot Welds**



However, one might ask why is adhesion phenomenon not observed when we set a book on a table then lift the book? The answer has something to do with the nature of the surfaces. Here we have to take into account the films of gas molecules and assorted oils preventing molecular bonding (Swartz and Miner, 1997). Furthermore, much of the load is being supported by spring-like compressions without bonding. If the load is removed or decreased, these springs help to snap any molecular bonds that have formed.

One way of testing the molecular bonding model of friction is by the use of Teflon. We can show through the Teflon that friction is very low ( $\mu < 0.1$ ) because it does not bond well with most things under most conditions.

Burns, Houston et al. (1999) showed evidence that strong adhesive forces due to hydrogen bonding lead to frictional loss not only because of dissipative intermolecular forces (e.g. bond breaking) at the contact interface but also in part because of tensile deformation (reorientation) and collective motion of the hydrocarbon chains. They concluded that energy

dissipation which steeply increases with adhesive forces can be attributed to tensile molecular deformation, collective molecular chain motion, and dissipative hydrogen-bond ruptures under tensile or adhesive stress.

The adhesion model cannot be the complete story, especially considering the messiness of real surfaces. During the sliding process, some of the rough spots will actually collide and be broken off. In essence, the above model can be a good explanatory model for friction without tear. However, whether through microscopic bond breaking or the fracturing of individual tiny peaks, the work done in pulling an object against friction ends up as thermal energy dispersed throughout the surfaces.

### ***2.5.3 Independent Oscillator Model (Tomlinson Model)***

Krim (2002) has observed that sound energy can be a major contributor to friction. This observation can explain the completely different nature of microscopic friction from the one usually observed at the macroscopic level. For example Krim and co-workers (2002) observed that solid films can be far more slippery than liquid films, contrary to most everyday situations, where liquids usually act as lubricants. According to them, friction arising from sound waves, or atomic-lattice vibrations, occurs when atoms close to one surface are set into motion by the sliding action of atoms in the opposing surface. In this way, some of the mechanical energy needed to slide one surface over the other is converted to sound energy, which is eventually transformed into heat. Hence, to maintain the sliding motion, more mechanical energy must be added, and one has to push harder.

Tomassone, Sokoloff et al. (1997) measured the friction force of one-atom-thick films sliding along flat solid surfaces through the use of quartz crystal microbalance. The set-up consists of a single crystal of quartz that oscillates at high frequency ( $5 \times 10^6$  -  $10 \times 10^6$  times per second). Crystalline metal film was deposited on the surfaces and then single-atom-thick films of different materials were deposited on the electrodes. The “rubbing” action of the film sliding about the substrate provided a measure of frictional-energy dissipation which reduces the amplitude of vibration of the single crystal of quartz.

Solids are much like musical instruments in that they can only vibrate at certain distinct frequencies, so the amount of mechanical energy consumed will depend on the frequencies actually excited (Krim, 1996). According to Krim, if the “plucking” action of the atoms in the



opposing surfaces resonates with one of the frequencies of the other, then friction arises. Otherwise, sound waves are not generated. This suggests a possibility of observing frictionless sliding. Recently, they have confirmed that friction increases in direct proportion to the sliding speed using one-atom-thick solid films sliding over crystalline silver and gold surfaces.

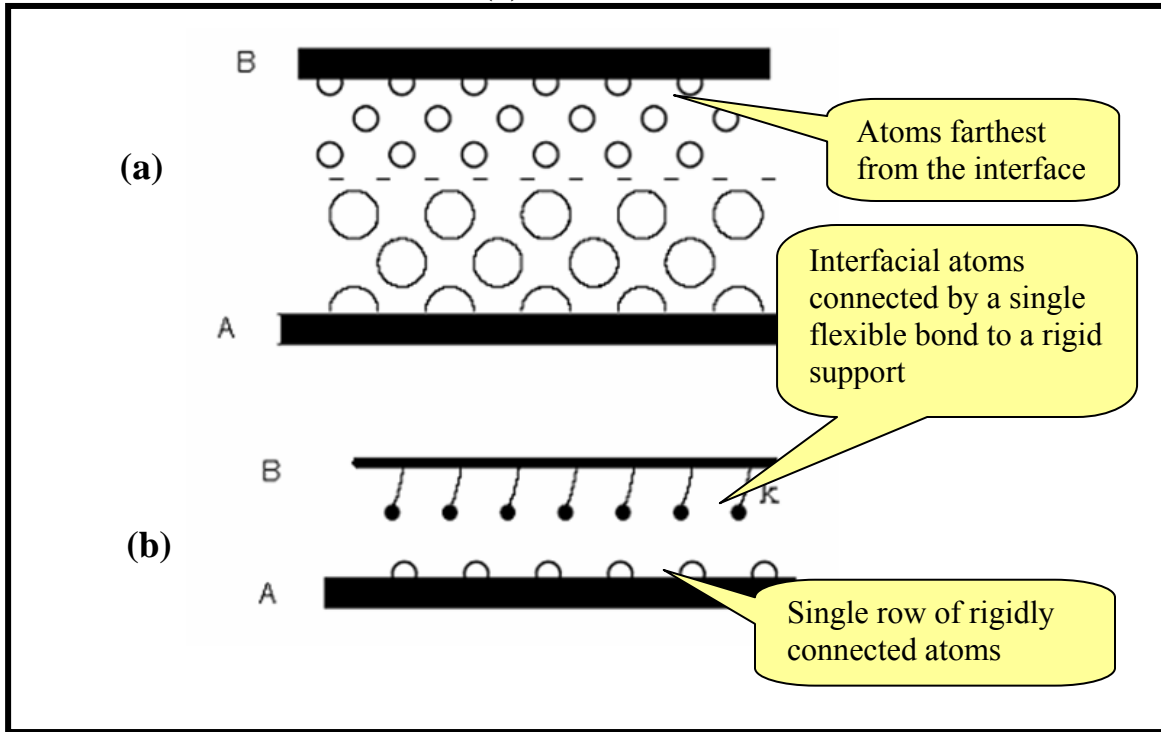
Computational studies are also currently undertaken in finding answers to the mysterious behavior of friction at the atomic scale. Robbins and co-workers (2001) simulated one-atom-thick krypton films sliding on crystalline gold surfaces. The simulations shows that liquid-krypton atoms, being more mobile than solid-krypton, could “get stuck” in the gaps between the solid-gold atoms more easily. In this situation, the shearing takes place between the solid and liquid surface rather than within the bulk of the liquid (which usually is the macroscopic case) which usually offers less shearing resistance than does a solid-liquid interface.

The Tomlinson model is by far the simplest model in describing wear-less friction for we can treat each atom on one surface as an independent oscillator (Robbins and Muser, 2001; Muser, Wenning et al., 2001; McClelland, Germann et al., 1993). In Figure 2.8, the row of interfacial atoms in surface B are treated as independent oscillators and hence do not interact with each other.

However, these oscillators experience a potential from the interfacial atoms of surface A. This is represented by the single bond in the figure. The above model is simple but it contains all the major elements of the wearless frictional problem -- movable surface atoms, a periodic corrugated interfacial structure, and a mechanism to dissipate vibrational energy created at the surface (McClelland, 1992).

The dynamics of the above model is based on the potential curves  $V_{AB}$  and  $V_{BB}$  which govern the lateral motion of a particular atom on B surface  $B_0$  as surface A slides

**Figure 2.8: (a) Two ideal, flat crystals making contact at the plane indicated by the dash lines. (b) Tomlinson Model**



by it as shown in Figure 2.9.  $V_{BB}$  is a simple parabolic potential well with curvature  $k_{BB}$ , representing the strong bond connecting  $B_0$  to solid B. One of the important ideas here is that for energy dissipation to occur there must be more than one local minimum in  $V_s$  (equivalent to requiring  $V_s$  to have a local minimum).

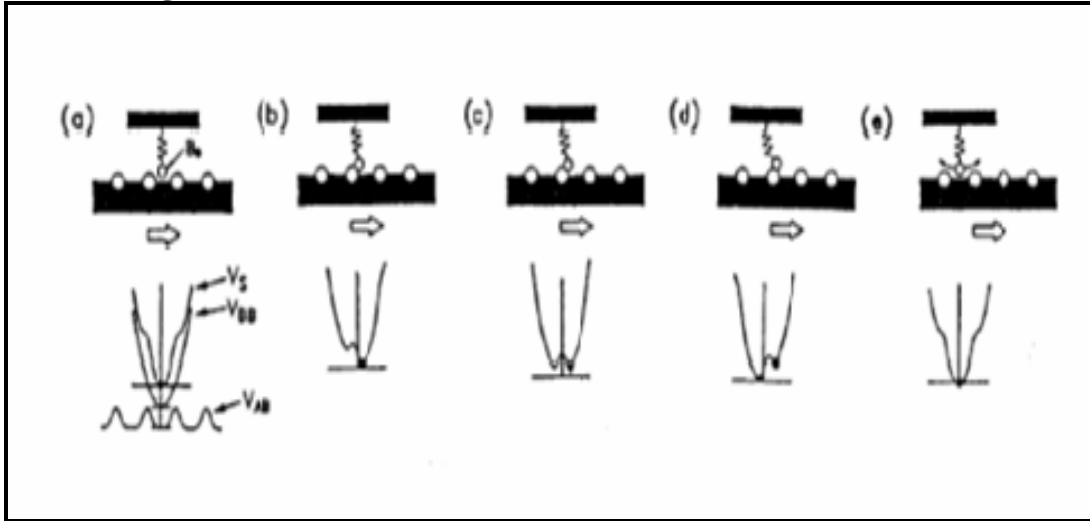
In Figure 2.9, we see that  $B_0$  remains in the changing minimum of  $V_s$  without becoming excited until the stages d and e where the local minimum disappears. At this point,  $B_0$  must fall abruptly to the bottom potential and thus become vibrationally excited.

The vibrational energy is then dissipated irreversibly in the solids. According to McClelland (1992), the potential  $V_{AB}$  has “plucked” the harmonic  $V_{BB}$  bond. It is at this plucking where the strain energy on B bond due to translation is converted to vibrational motion (heat). This mechanism can not occur if interfacial forces are sufficiently weak.

This implies that when two solids slide across each other, breaking interfacial bonds and distorting intra-solid bonds at the interface requires energy. For the strong interaction “plucking” case, the potential energy is not returned; the new bonds are formed and the relaxation occurs instantaneously, so that energy is not regained as mechanical energy but dissipated to the rest of

the solids as phonons (McClelland, 1992). Energy is dissipated as surface 'A' moves from (d) to (e).

**Figure 2.9: Motion of an atom  $B_0$  described by the independent oscillator model. The net potential affecting  $B_0$  is  $V_S = V_{AB} + V_{BB}$**



Recently, sliding friction has been probed on an atomic scale using a variety of techniques (e.g. atomic force microscopy, quartz crystal microbalance). Below are some of the significant findings of research done in pinning down what is happening at the microscopic level:

- In macroscopic friction experiments it is usually found that the friction force vanishes continuously when the load  $L \rightarrow 0$  as implied by Coulomb's friction law. This is not usually the case in experiments involving a single asperity contact area, such as friction force microscopy with smooth probing tips. Friction force is finite for  $L=0$  and for small negative values (Ringlein & Robbins, 2004).
- Microscopic friction is dependent on the actual contact area. (Bowden & Tabor, Burns et.al, 1998; Robbins & Ringlein, 2004; Krim, 1996)
- Stick-slip on the atomic scale has been observed (Krim, 2002; Bennewitz et.al 2001; Mate, et.al,1987)

Robbins and Ringlein (2004) propose that friction can be better described at the atomic scale by the equation:

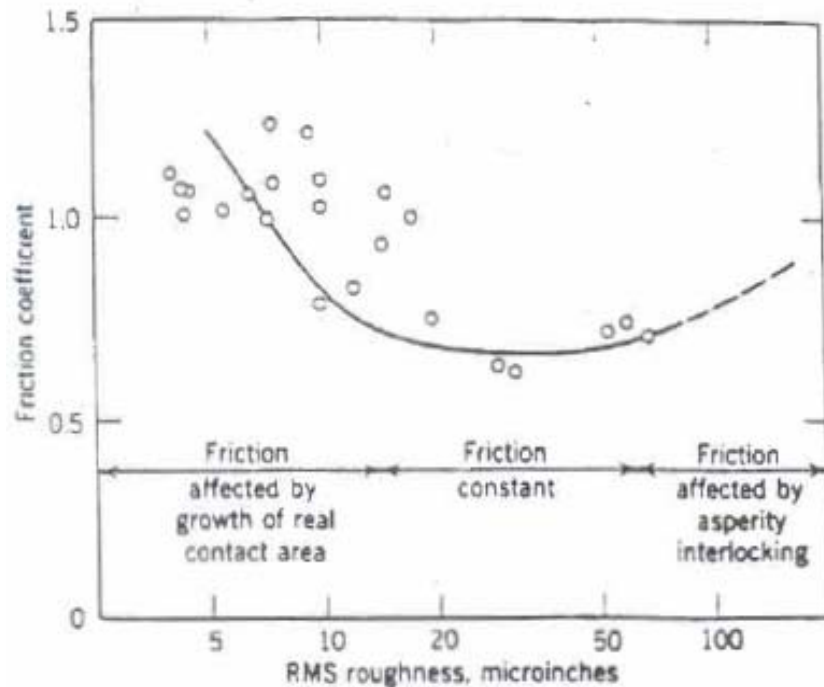
$$f = \mu N + cA \quad (2.4)$$

Where

‘c’ is the force needed to overcome electrical interactions between atom pairs, and  
‘A’ is the atomic area of contact (pairs of atoms in close contact) between the surfaces.

According to Rabinowicz (1992), friction varies with surface roughness as shown Figure 2.10. It can be seen that for some intermediate roughness the friction tends to be independent of the roughness. But at both extremes, the friction goes up. Friction goes up when the roughness increases due to interlocking of asperities. Friction also goes up when the surface roughness decreases due to the growth of real contact area.

**Figure 2.10: Plot of friction coefficient against surface roughness.** (Source: I.L. Singer and H.M. Pollock. *Fundamentals of Friction: Macroscopic and Microscopic Processes*. Kluwer Academic Publishers. p.26)



The aforementioned ideas about microscopic friction were some of the bases in coming up with the target ideas in this study which were subsequently used in the design of the activities for the teaching experiment done in the second phase of the research.

## 2.6 Perspectives on Transfer of Learning

Several transfer studies (Adams, Kasserian et al., 1988; Bassok, 1990; Brown and Kane, 1988; Chen and Daehler, 1989; Lockhart, Lamon et al, 1988; Nisbett, Fong et al., 1987; Novick, 1988; Perfetto, 1983; Brown, 1983; Reed, 1993; Reed, Ernst et al., 1974) have focused primarily on looking at how students apply previously learned problem solving strategies in a new context.

In Gick 1980& Holyoak's (1980) study involving the "fortress vs. tumor" problem, students were expected to learn a certain problem-solving strategy (fortress problem) and apply it in a new context ("tumor" problem). The two problems have deep structural similarities and it was hoped that students will see similarities through analogical transfer and were expected to be successful in solving the transfer problem. Within this perspective of transfer, researchers typically pre-define the concept that is to be "transferred" and then they look for evidence of transfer in a context quite different from the context where the concept was initially learned. Researchers involved in this type of study look at transfer from a purely cognitive perspective. Researchers adopting the aforementioned perspectives usually find that transfer is rare.

On the other hand, several researchers view transfer in a rather different perspective. Lobato's (1996) "Actor Oriented" view of transfer focuses on identifying *any* knowledge that students may transfer to a new situation. This view has its origin in the ideas of "perceived similarities" by Hoffding (1982) and "situated cognition" by Lave and Wenger (1991). It relies on "personal creations of relations of similarity" by the learner rather than similarities from the researcher's perspective.

Greeno, Moore et al. (1993) on the other hand, considered the socio-cultural aspects of transfer. They began to consider how the factors external to the student such as interactions with the environment and social interactions with peers or the teacher affect the transfer. They focused on activities that the learner performs in the learning context. While performing these activities, the learner becomes attuned to the affordances of the learning situation and its potential state of affairs and brings these aspects of the learning context into the transfer context to solve the problem.

Similarly, Bransford and Schwartz (1999) describe transfer in terms of whether it adequately prepares students to learn in the future. Based on this perspective, they focus on whether and how students *learn* to solve the problem in the transfer context. These authors

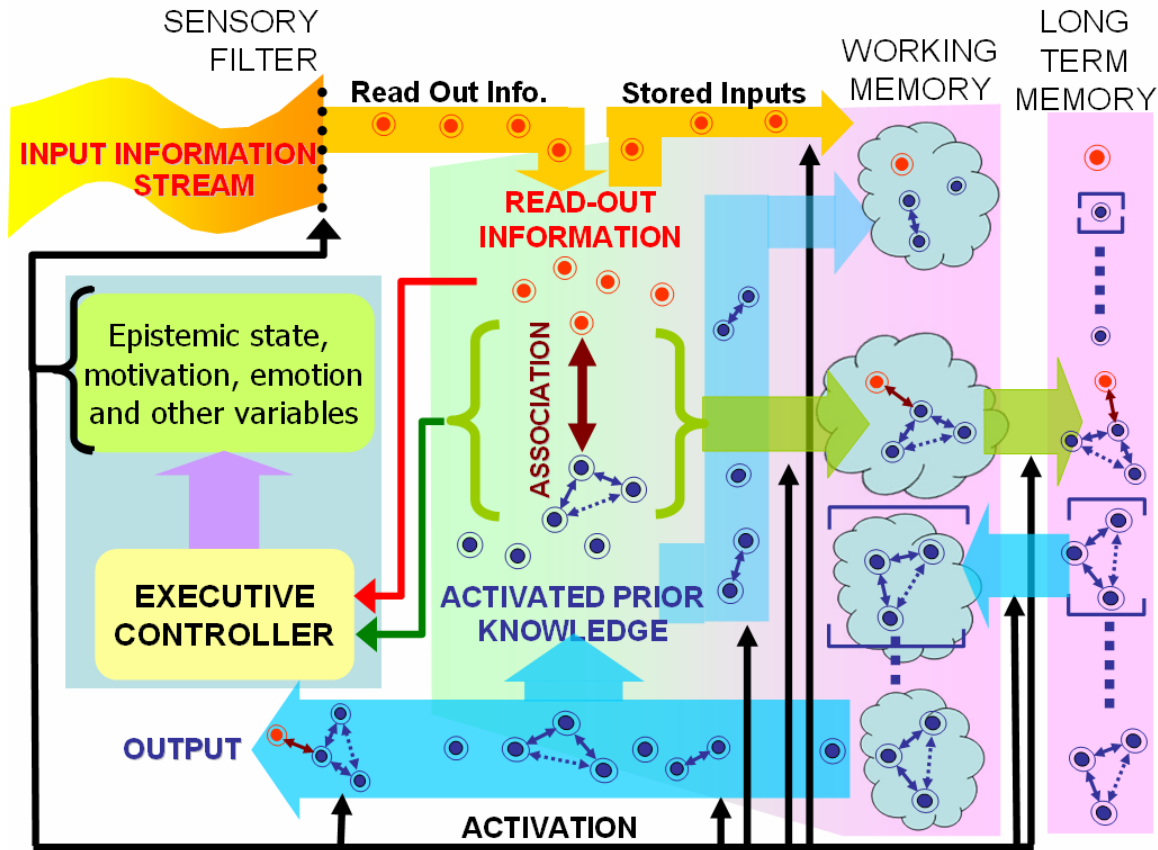
believe that transfer of learning would most likely occur if students are given opportunities to reconstruct their learning in the transfer context just as they did in the learning context.

According to Rebello, Zollman et al. (2005) we must examine transfer from students' perspective rather than a pre-defined researcher's perspective. Transfer is a dynamic phenomenon in which learners' construct their mental model or knowledge structure in the target scenario, rather than merely apply what they have learned in the learning scenario to the transfer scenario. In constructing the new target structure in the target scenario learners make associations between elements of the input information that they read out from the target scenario and elements or existing knowledge structures stored in their long term memory.

We should not focus only on students' internal knowledge but on different mediating factors such as the learners' epistemic state, level of motivation for the task and kinds of emotion. These mediating factors help filter the input information, the prior knowledge activated from long-term memory, and what the learner decides to store from their working memory into their long term memory. These mediating factors do not just affect the aforementioned aspects of transfer, but are also in turn are affected by the kinds of associations that a learner might generate in a given situation to as to create a mighty feedback loop with several paths and influences as shown in Figure 2.11.

In my research, I adopt the aforementioned contemporary perspectives in investigating the issue of transfer of learning. I subscribe to the idea of Bransford and Schwartz (1996) that students construct or reconstruct their knowledge in new context. Also, I personally believe that in looking at transfer one should not pre-decide what transfers but rather one should examine everything or anything that is transferred (Lobato, 1996). Finally, in my research I also consider the socio-cultural aspect of transfer (Greeno, Moore et al. 1993) as students construct and reconstruct their knowledge through interactions with other peers or the instructor.

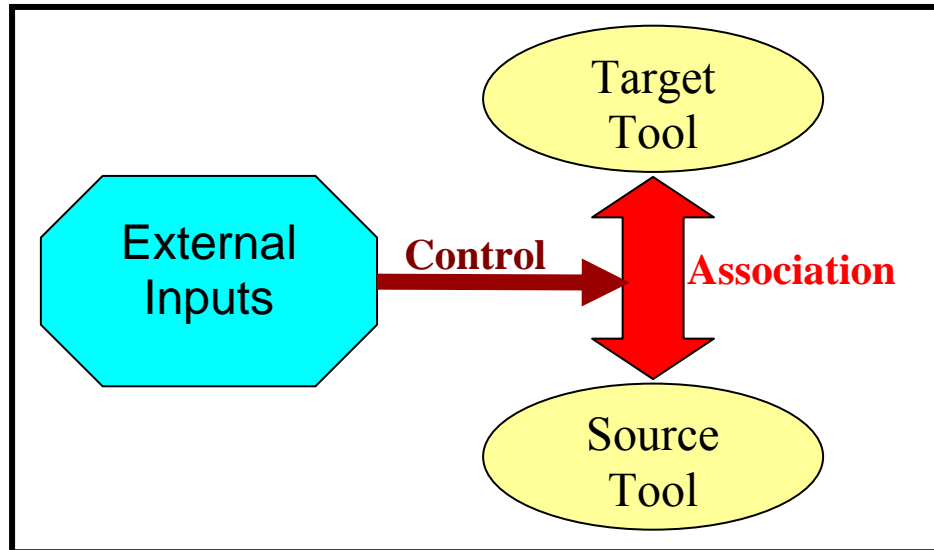
**Figure 2.11: The dynamic transfer model showing various feedback paths.**



In studying the dynamics of students' construction and reconstruction in the context of transfer I adopt the two-level framework (Figure 2.12) proposed by Redish 2004). Within certain segments in the teaching interview I will be determining the external inputs, what source tools get activated and what controls this activation.

I then look at the association that they make. In my framework these associations, in and of themselves, constitute transfer. Note, that I do not make a value judgment on whether or not these associations are scientifically correct. Rather I adopt a value-neutral stance with regard to these associations and attempt to examine all possible associations that a student makes.

**Figure 2.12: The Transfer Model based on Redish's two-level framework (2004)**



## **2.7 Collaborative Learning**

Several researchers (Johnson and Johnson, 1992; Kampulainen & Mutanen; Slavin, 1992; Webb & Palinscar, 1996) have shown that collaboration can enhance students' learning. In looking at how collaboration contributes to students' learning, Sawyer (2006) proposed the use of *interaction analysis*. Interaction analysis is designed to analyze naturally occurring conversation as students engage in classroom activities. Sfard and Kieran (in Sawyer, p. 197) used interaction flowchart in order to depict the actions that participants do in a collaborative activity. In my research, the dynamics of students' interactions during the group teaching interviews will be analyzed in terms of the assimilation of resources and/or accommodation of models.

Forman (1992), Forman & Cazden (1985) and Palinscar (1998) have looked at how participants build on each other's ideas to jointly construct a new understanding. Their data emerged from analysis of conversations among participants. This idea is consistent with the aim of the group teaching interviews that were conducted. In the group teaching interviews, students' conversations with the researcher-interviewer and their peers were examined in order to investigate the ways and means by which students collaborate in the model-building activities.



## **2.8 Motivational Aspect of Learning**

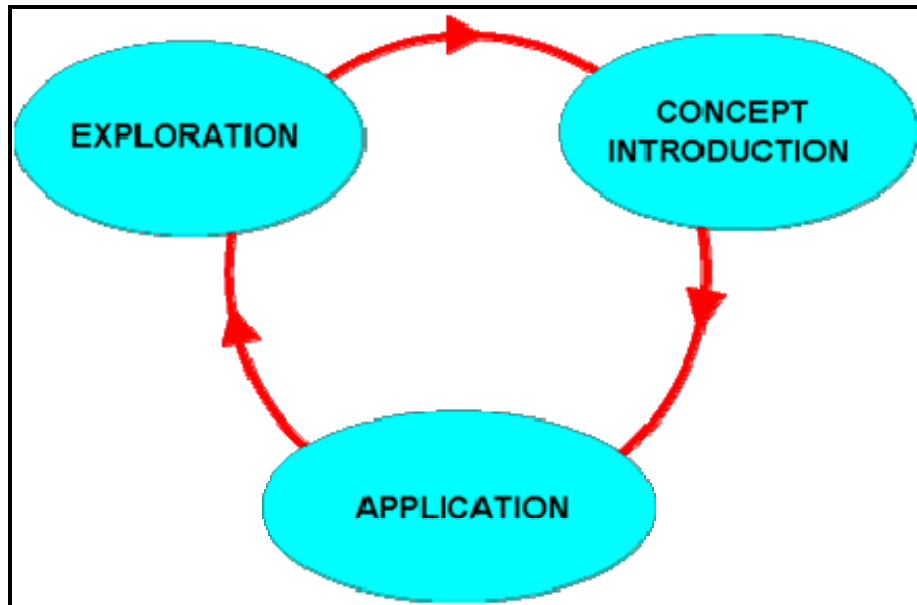
Research (McCombs, 1996; Pintrich, 1996) has shown that learners are increasingly motivated when they can see the usefulness of what they are learning to everyday life. White describes how this “competence motivation” often translates into a greater amount of time and effort that students are willing to devote to learning. When Barlia and Beeth (1999) created individual motivational profiles for students in a calculus-based course, they found that “task value” was the principal motivational factor for most students. Thus, this finding indicates that teachers need to demonstrate the value of participating in conceptual change, and that students need to find applications for their new conceptions within their everyday lives. Duch (1996) studied students in an honors general physics course that focused on the applications of physics to the human body and medicine and found that active group learning and connections to real-world applications help students learn physics. Two independent studies (Rennie, 1996; Ferguson, 1995 ; Oliver & Oliver, 1997) that compared student learning and performance on tasks with and without real-world contexts found that student learning was enhanced by real-life contexts. Cognitive and neuroscientists such as Kovalik (1998) who have created an integrated thematic instructional model using the results of brain research, have also found that emotion and prior experiences in the learning process can influence how students learn. They have identified specific neurotransmitters and sensory input needed for students who lack prior real-world experience with the learning topic.

## **2.8 Pedagogical Framework**

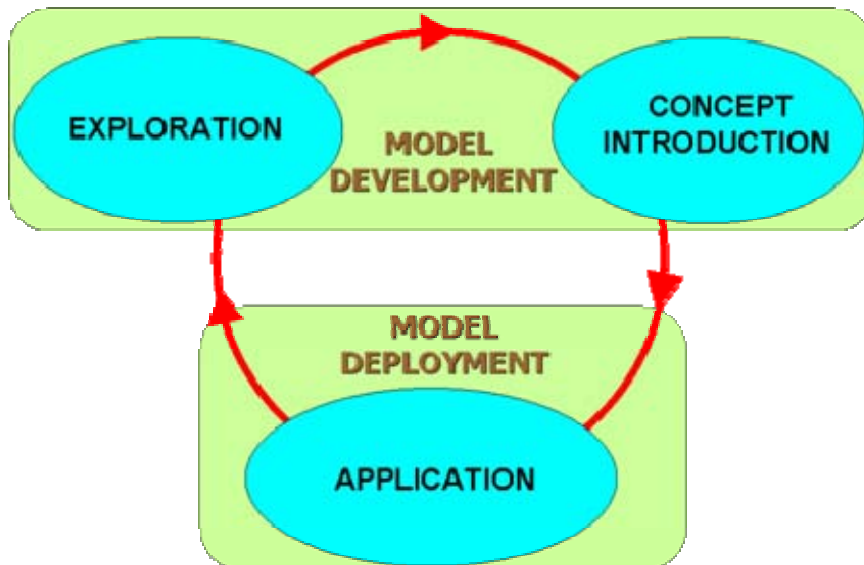
In facilitating the students’ model construction and reconstruction in this research, they were engaged in activities set-up in a way that students go through a learning cycle. In my research I was guided by Karplus’ Learning Cycle (1974) as shown below. Karplus’ Learning Cycle depicted in Figure 2.13 is a research-based curriculum innovation with an emphasis on the development of students’ reasoning skills. It consists of three cycles -- exploration, concept introduction and application. It has been adopted in wide variety of situations and many variations had been created. One of these is Hestenes’ Modeling Cycle (Wells, Hestenes et al., 1995).

Figure 2.14 shows Hestenes' Modeling cycle and how it encompasses Karplus' Learning cycle. Hestenes' model development corresponds to Karplus' exploration and

**Figure 2.13: Karplus' Learning Cycle**



**Figure 2.14: Hestenes' Modeling Cycle and Karplus' Learning Cycle**



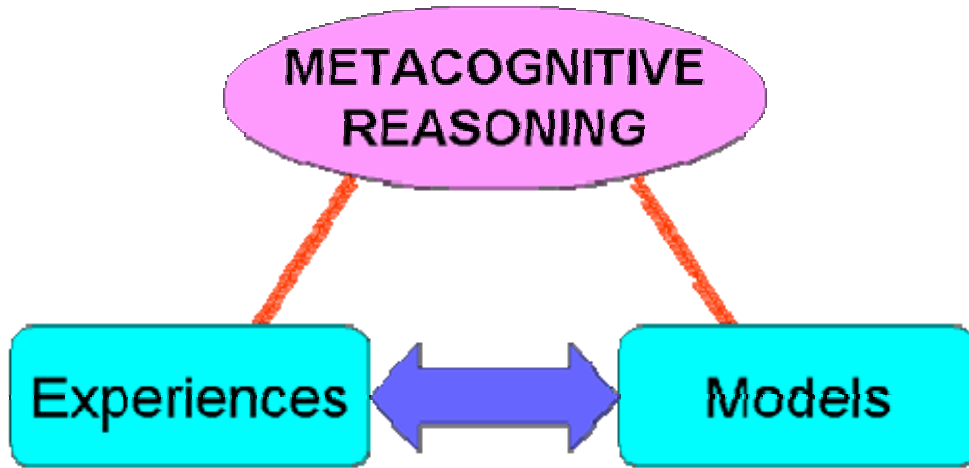
concept introduction phases while Hestenes' model deployment corresponds to Karplus' application phase. Hestenes' Modeling Cycle has been shown to be effective in making learning of physics more meaningful to students.

## **2.9 Theoretical Framework**

In this research I adapted an amalgamation of Vygotsky's social constructivist as well as Piaget's cognitive constructivist perspectives. I believe that these two perspectives are not mutually exclusive and that they are in fact mutually reinforcing since they lie very close to each other in each of the three dimensions outlined by Phillips. Both the Piagetian and Vygotskian perspectives view learning as a dynamic process where students construct new ideas and skills and reconstruct previous knowledge through interactions with their environment including their social environment.

German Researchers Mikelskis-Seifert and Fischler designed a multidimensional approach to the understanding of particle models which they called the Level System of Multiple Representations (see Figure 2.15). One important feature of their framework is the metacognitive reasoning aspect. The metacognitive reasoning feature entails the need for students to reflect and try to make sense of what is happening in the macro-and microworld. This makes the students mentally engaged in what they are doing. The level systems of multiple representations are consistent with the constructivist point of view of Learning. In Piaget's theory of learning he emphasizes the important role of cognitive conflict which induces productive learning. I believe that providing students with activities that produce cognitive conflict makes them mentally engaged so that they can reflect on the comparisons between their macroscopic experiences and microscopic models. Furthermore, this notion of having students compare and contrast the macro and microscopic views of a phenomenon is also consistent with Bransford's idea of 'contrasting cases' (Bransford, Franks et al., 1989).

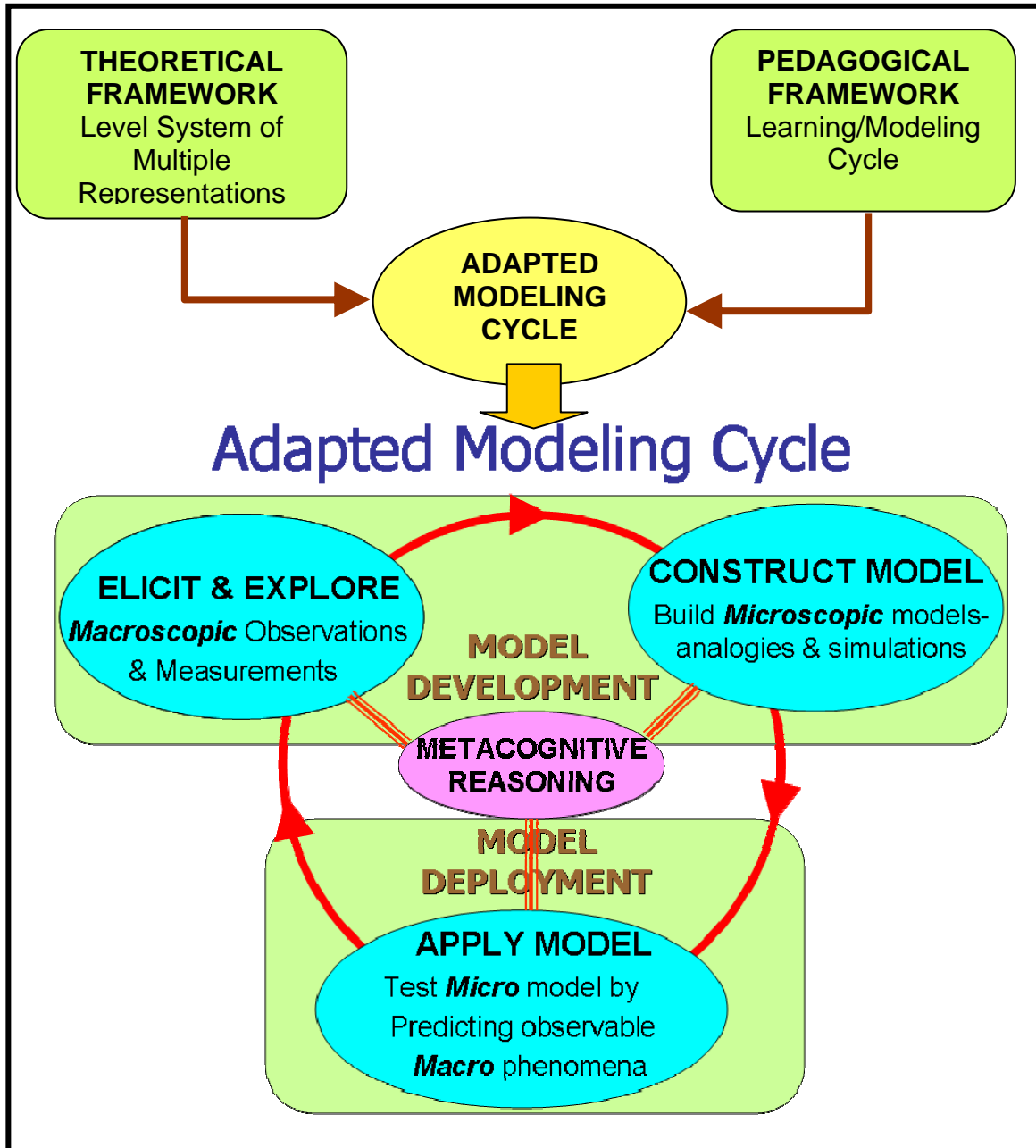
**Figure 2.15: Level Systems of Multiple Representations**



### **2.10 Research Framework**

Based on the theoretical framework of the Level Systems of Multiple Representations and the pedagogical framework of the Learning and Modeling Cycles as well as constructivist view of learning owed to Piaget and Vygotsky discussed above I arrived at an adapted modeling cycle consisting of three phases (Figure 2.16). The adapted modeling cycle guided the design and planning of the different tasks in studying the dynamics of students' model construction and reconstruction in the context of microscopic friction. In the next chapter I will discuss the research design based on the ideas presented in this chapter.

Figure 2.16: Adapted Modeling Cycle



## 2.11 Chapter Summary

In this chapter a selected review of related research covering constructivist perspectives of learning, conceptual change processes, models and modeling, perspectives on transfer, and motivational aspects of learning is presented. The chapter concludes with a discussion of the pedagogical and research framework of the study.

According to the constructivist perspective of learning, students dynamically construct their knowledge from external experiences and interactions with their environment. Thus, learning occurs as the learners construct new knowledge and skills as well as modify their existing knowledge and skills.

Phillips 1995) proposes three dimensions in looking at constructivism- ownership of knowledge (individual psychology versus public discipline), creation of knowledge (human the creator versus nature the instructor) and process of learning (construction versus transmission). In terms of the ownership of knowledge dimension I am taking the perspective that learning is the construction of meaning by individuals from interaction and experiences with their environment. In terms of the second dimension (creation of knowledge) I am adopting the perspective that knowledge structure serves only to organize the learner's experiential world and has no absolute correspondence with the natural world. In terms of the third dimension I subscribe to the perspective that knowledge is constructed through active engagement. Piaget and Vygotsky are both on this side of the scale for they both stress that the learner is both mentally and physically engaged in the processes of construction and internalization.

In the process of knowledge acquisition or construction , two basic processes may be involved according to Piaget - *assimilation* and *accommodation*. *Assimilation* occurs when we try to incorporate new knowledge into our pre-existing schema without reorganization of our previous mental structures. *Accommodation* on the other hand occurs when one tries to modify pre-existing schema in adapting to a given situation. In this research I investigated the process by which students assimilate new ideas and modify their existing schema to accommodate new experiences.

Meanwhile, Vygotsky views learning and development as a result of social interactions. One of the key concepts in his theory of learning and development is the notion of the Zone of Proximal Development (ZPD) which is the cognitive “distance” between what an individual can

accomplish on his/her own and what he/she can accomplish when assisted by more capable peers or adults. If learners are within their ZPD, then they can learn the material (which is impossible for them to learn on their own) with assistance from more experienced peers or instructors. This structured and systematic assistance is referred to by Bruner (1976) as scaffolding. In this research I provided different scaffolding activities to students as I tried to investigate the dynamics of their knowledge construction.

In this research a mental model is my own representation of what I believe students think of a certain physical phenomenon -- friction. I believe that students construct these models *in vivo* while answering questions during an interview -- predicting and explaining why a system behaves in a particular way in a given context. These views are consistent with those of Franco and Colinvaux (2000), Vosniadou (1994), Gentner and Stevens (1983) and Rouse and Morris (1986). Moreover, the term ‘mental model,’ in my research, actually refers to the model that I constructed to describe what I believe the students are thinking.

Also, in this chapter, the contemporary perspectives of transfer adopted in this research were also discussed. One of the perspectives is that one should look at transfer from students’ perspective rather than a pre-defined researcher’s perspective. On the other hand transfer is viewed as a dynamic phenomenon in which learners dynamically construct their mental model or knowledge structure in the target scenario, rather than merely apply what they have learned in the learning scenario to the transfer scenario. Lastly, transfer studies should not focus only on students’ internal knowledge but on different mediating factors such as a students’ epistemic mode, level of motivation or types of emotions associated with the learning experience. In this research I adopted the aforementioned contemporary perspectives in investigating the issue of transfer of learning.

The pedagogical and theoretical frameworks of the study were also thoroughly discussed in this chapter. In structuring the teaching interviews and designing the instructional material I used learning cycles which are a blend of Karplus’ and Hestenes’ Learning Cycles. Moreover, in facilitating the students’ model construction and reconstruction in constructing a more scientific model of microscopic friction I adopted the “level systems of multiple representations” framework which is also consistent with the constructivist point of view of learning. Finally, at the end of this chapter the research framework which evolved from the pedagogical and theoretical frameworks of the study is presented and discussed.

## CHAPTER 3 - Research Design

### 3.1 Introduction

This chapter describes the existing curriculum in which friction is taught, the research setting and the preliminary research project plan. The philosophical and methodological perspectives that influenced the design and analysis phases are likewise discussed. The latter part of this chapter provides a detailed discussion of the research tools employed in the study and concludes with the fully developed research plan.

### 3.2 Educational Environment

The curriculum for introductory college physics students primarily discusses phenomena at the macroscopic level. Most textbooks used across different levels simply state that force of friction

1.) is equal to the product of the coefficient of friction,  $\mu$  and the force of normal reaction,  $N$ .

In other words force of friction =  $\mu N$ .

2.) does not depend on the surface area.

These rules are called Amonton's Laws of Friction. But recent research in nanotribology has shown that these laws are not quite true at the nano scale.

With the advent of nanoscience and nanotechnology, I believe that there is a dire need to provide opportunities for learners to become aware of the strange behavior of physical phenomena at the nanoscale, especially when these phenomena are counter-intuitive with respect to their everyday macroscopic experiences. Friction is a phenomenon that students are familiar with at the macroscopic level.

In this project I ask: Can we expand the existing curriculum in order to integrate a microscopic treatment of friction? Can we design scaffolding activities which build on students' prior ideas to suit the diverse abilities of students from different streams, such as students in a conceptual-based course for non-science majors or in a more mathematically-based course for science majors?



### 3.3 Research Setting

This study was conducted at the main campus of Kansas State University (KSU), Manhattan, Kansas. KSU is a land-grant university enrolling about 22,000 undergraduates and about 5000 graduate students. The participants of our study were taking one of the following introductory physics courses: The Physical World, Concepts of Physics, General Physics, Engineering Physics and Contemporary Physics. Below are descriptions of the format, breadth and academic backgrounds of students taking these aforementioned courses.

*The Physical World* is a conceptual-based three-credit course designed to present an overview of the physical sciences for students who have little or no previous background in this area. Very few of these students have taken physics in high school. Students enroll in one of the lecture sections, each of which meet three times week for 50 minutes in a large lecture class of about 150-170 students taught by the course instructor. There is separate one-credit laboratory course, but students are not required to take the one-credit laboratory concurrently with this class.

*Concepts of Physics* is a conceptual-based three-credit course targeted toward elementary and early childhood education majors. Very few of these students have taken physics in high school. The course, which was designed by Zollman (1990) nearly 25 years ago uses the Karplus' Learning Cycle (Karplus & Renner, 1974) adapted to a large-enrollment format. In the early part of each week students drop into an Activities Center for about an hour to perform a set of exploration activities that activates their prior knowledge and give them a set of shared experiences. These experiences are the focus of discussion in class on Wednesday, which is the Concept Introduction phase of the Learning Cycle. In the second half of the week students return to the Activities Center to complete a set of Application activities which require them to apply the concepts learned in the Concept Introduction phase. The lectures on Friday and Monday focus on the Application activities.

*General Physics* is a two-semester introductory algebra-based physics course taken by students majoring in life sciences. A significant percentage of the students in this class have typically taken physics in high school. Students separately enroll in lecture, recitation and laboratory. The lecture meets for two hours each week, the laboratory for two hours and the recitation for one our each week. The recitation and laboratory classes run concurrent with the lecture.

*Engineering Physics* is a two-semester introductory calculus-based physics course taken by students majoring in engineering or in physics in their freshmen or sophomore year. Almost all of these students have taken physics in high school. Students enrolled in engineering physics attend two one-hour lectures per week in a large-enrollment lecture taught by the instructor. They also attend four hours per week of studio. Each studio class has a maximum of 40 students. The studio, which is a adaptation of Studio Physics first developed Wilson at Rensselaer (Wilson, 1994) is basically an integration of recitations and laboratories. In the studio the students do hands-on activities and discuss how to solve physics problems.

Contemporary Physics is a course on the recent advances in physics which is designed for non-physics majors. It emphasizes conceptual understanding rather than the mathematics and students learn through hands-on and computer simulations. Students enrolling in this course usually come from diverse physics backgrounds.

I cast a wide net of participants from all of the above courses. No attempt was made to take a representative sample from each course based on gender, ethnicity or performance in class. In some cases volunteers were offered \$10 per hour for participation in the study. In other cases, volunteers were offered a few points of extra credit in the course for their participation in the study.

### **3.4 Research Plan Overview**

This research consists of different phases. In the first Phase, I looked into the variations in students' mental models of friction at the microscopic level and also established, through interviews with experts and other sources the target model of microscopic friction that students can achieve through instruction. In the Phase II, I then looked at the ways in which students' construction and reconstruction of ideas about microscopic friction can be scaffolded so that they progress toward the target model. Furthermore, students' conceptual development was studied as they were provided different scaffolding activities. Based on insights on students' learning trajectories I developed an instructional module to help students construct the target model of microscopic friction. I also developed embedded formative assessments as well as pre/post summative assessments to assess student learning using the module. In Phase III, I pilot-tested the developed instructional module which was then pilot tested with students.

I used a multi-methodological approach in this study. In the fact finding phase (Phase I) I used a blend of a grounded theory approach and phenomenology. Data were generated from different sources -- students, physics content experts and existing literature and a variety of data collections techniques were used. In Phase II, in looking at the dynamics of students' construction and reconstruction of ideas, I used a phenomenological approach. Phase II culminated in the development of an instructional module and assessment tasks. Finally, in Phase III, I used an approach similar to that used in action research to evaluate the developed instructional module in the classroom.

### **3.5 Philosophical, Methodological & Theoretical Perspectives**

This section starts out with a discussion of the four assumptions that a researcher makes in order to understand social reality and research. These assumptions gave me a better sense of how I should approach my research in general. The theoretical as well as the methodological perspectives which guided my choice of the research methodology and research tools that are deemed appropriate and necessary in realizing the research plan are also presented. The two theoretical constructs (phenomenology and constructivism) in which this research is anchored are likewise presented. This section concludes with the presentation of the final research plan which evolved from the preliminary research plan. The final research plan maps out the appropriate methodologies and tools for carrying out the research.

#### ***3.5.1 Philosophical Assumptions***

It is essential for a researcher to clearly articulate the philosophical assumptions that he/she brings with him/her in carrying out a research. These assumptions have significant impact on the collection and analysis of data and in generating conclusions or generalizations as well. In this section the different assumptions of human nature, nature of social phenomena, bases of knowledge, and selection of methodology which influenced me in selecting the appropriate methodologies and research tools are presented.

According to Cohen and Manion (1994) there are four assumptions under which a researcher should approach social reality and research.

#### ***Ontological Assumptions***

Ontological assumptions are the assumptions that one makes about the very nature or essence of the social phenomena being investigated. Is social reality external to individuals (given out there in the world) or is it the product of individual consciousness (created by one's own mind)? This question results from the nominalist-realist debate. The nominalist views objects of thought merely as words and that there is no independent accessible thing constituting the meaning of a word. On the other hand, realist contends that objects have an independent existence and are not dependent for it on the knower (Cohen and Manion, 1994, p.6). In this research, in looking at the social aspect of knowledge construction, I adopted the assumption that social reality is a product of individual consciousness. That is, it is created by one's own mind. Therefore, in a sense I operated under nominalist ontological assumptions.

### *Epistemological Assumptions*

Epistemological assumptions concern the very bases of knowledge- its nature and forms, how it can be acquired, and how it is communicated to other human beings. (Cohen and Manion, 1994). Positivists view knowledge as hard, objective, and tangible while anti-positivists view knowledge as personal, subjective and unique. The positivist view demands that the researcher simply take an observer role while the anti-positivist view imposes an involvement of the researcher with his/her subjects.

In addition to examining the researchers' epistemological assumptions, I also examined my assumptions about the learners' epistemological stance. Conventionally, researchers adopted what has been referred to (Hammer, Elby et al., 2005) as a "unitary ontology" to describe a learner's epistemological beliefs. More recently this thinking has given way to a "manifold ontology" to describe learners' epistemology. Rather than consider learners to have a set of epistemological beliefs consistent across various learning situations, learners operate in different epistemological modes depending upon the context. Hammer and Elby 2002) believe that learners possess epistemological resources ("knowledge as propagated stuff," "knowledge as free creation," "knowledge as fabricated stuff") which are analogous to diSessa's phenomenological primitives (p-prims). A learner invoking the "knowledge as propagated" resource treats knowledge as a kind of stuff that can be passed from a source to a recipient. Meanwhile learners who invent their explanations are invoking the "knowledge as free creation". Learners who invoke the "knowledge as fabricated" resource treat knowledge as something inferred or developed from other knowledge.

In looking at the variation in students modeling of friction and dynamics of their knowledge construction I adopted the anti-positivist assumption that knowledge is personal, subjective and unique. Moreover, I subscribe to the view that learners do activate certain epistemological resources in constructing/reconstructing their knowledge. In examining students' construction and reconstruction of their mental models, I also sought to identify the epistemic mode that learners were operating under and the epistemological resources that they were using.

### ***Assumptions Regarding Human Nature***

This set of assumptions concerns the relationship between human beings and their environment. Burrell and Morgan (1979) point out two perspectives on the nature of relationship between human beings and their external world. One of the perspectives views human beings as responding in a mechanistic or even deterministic fashion to the situations encountered in their external world. In this mechanistic perspective, human beings and their experiences are viewed as products of the environment. Meanwhile, the other perspective views human being having a "free will" to control his environment. In this perspective, human beings are the creator of their environment.

In this research I am adapting a view which is primarily a mechanistic perspective. I believe that learners bring into the classroom pre-scientific ideas that are based on their everyday experiences. In making sense of unfamiliar situation learners activate explanations based on their everyday experiences. In studying the dynamics of model building of students I created an environment which provided them a specific context in which their knowledge construction is anchored. In this context, learners' actions are clearly a product of the environment they are exposed to.

### ***3.5.2 Methodological Perspectives***

The researchers' assumptions about human nature, ontology and epistemology have a great impact on the choice of appropriate methodologies. I believe that as a researcher, my choice of methodologies and research tools are dictated by the philosophical perspectives that I adopt.

Mertens (2005) outlines four research paradigms based on different philosophical assumptions that guide and direct thinking and action: post-positivism, constructivist,

transformative and pragmatic. In my research, I needed to adopt a blend of the constructivist and pragmatic paradigm because of the diverse purposes of this study.

In looking at the variations in students' mental models of microscopic friction I adopted a rather subjectivist perspective to the social world. This subjective perspective stresses the importance of the subjective experience of individuals in the creation of the social world. The use of a grounded theory and phenomenological approach are deemed appropriate for this end. Based on my review of existing literature these approaches are also sensitive to the ontological and epistemological assumptions that I am taking on in this research.

In studying the dynamics of students' knowledge construction I used a "phenomenological" approach which is consistent with the constructivist paradigm – reality is socially constructed. Meanwhile in the formative evaluation of the developed instructional material I adopted the pragmatic paradigm. I believe that the use of mixed methods is the most appropriate way of addressing this issue. A combination of both qualitative and quantitative method is deemed necessary to best evaluate the developed instructional material.

In a nutshell, my choice of adopting a multi-methodological approach in my research was dictated by the philosophy, the assumptions that I take on and the diverse purposes of this research. This notion is consistent with Holloway's view that "a researcher selects the methodology which encapsulates the philosophy, principles, and assumptions they hold about the nature of their research. It consists of the ideas underlying data collection and analysis." (Holloway 1997, p105).

### ***3.5.3 Theoretical Perspectives***

#### ***Phenomenology***

Most of qualitative works are anchored on the philosophy of phenomenology (e.g. phenomena should be studied without preconceived notions). Phenomenology has had an impact on philosophical thinking and served as a basis for qualitative research in areas of health and illness, in psychology and in educational inquiry. According to van Manen (1990) phenomenology describes how one orients to lived experience. The feature that distinguishes phenomenological research from other qualitative research is its focus on the subjective experience resulting from the inquiry. According to Patton (2002) in a phenomenological research one looks at the meaning, structure, and essence of the lived experience of a given

phenomenon for a particular person or a group of people. The intent of the researcher is to understand and describe an event from the point of view of the person experiencing it. Phenomenology is not a method itself, hence researchers who use this approach are reluctant to describe specific techniques, rather they describe phenomenology as a guiding principle that shapes the way in which they conduct their research. (Holloway, 1997, p 118).

### ***Constructivism***

Constructivism as a learning theory presupposes that students' minds are not blank slates or *tabula rasa* to be filled. According to constructivist perspective, learners come into the classroom with their prior knowledge, skills and beliefs that greatly affect the way they think and learn. Von Glasersfeld (1995) argues that "from the constructivist perspective, learning is not a stimulus-response phenomenon. It requires self-regulation and the building of conceptual structures through reflection and abstraction." (Glasersfeld, 1995, p.14). Phillip (1995) provides an excellent overview of the major types of constructivist perspectives that were presented in Chapter 2.

In this study I am concerned primarily with the perspectives of Piaget and Vygotsky. Both of these perspectives have been discussed in detail in Chapter 2. Below I discuss those ideas from these two perspectives that are most relevant to this study.

As per Piaget, conceptual change occurs when a learner is faced with a discrepant event in which predictions based on the learner's existing schema are contradicted by observations. This cognitive dissonance can often motivate a learner to reexamine his/her schema in the light of the new evidence. At this point, if a learner is provided the appropriate instructional scaffolding (Bruner *et. al.*, 1976) we can facilitate the process through which he/she can construct a new schema that can explain his/her observations, thereby resulting in conceptual change.

Vygotsky's theory is very similar to Piaget's but Vygotsky places more emphasis on the social interaction. Central to the Vygotskian perspective is the Zone of Proximal Development (ZPD) within which a learner can learn with assistance from more capable peers or adults. A learner's ZPD can be extended with scaffoldings from instructors, peers and learning materials (Bonk and Cunningham, 1998; Gredler, 1997 and Bruner, 1984).

In this research I adapted an amalgamation of Vygotsky's and Piaget's perspectives. As pointed out by Cobb (2005), I believe that these two perspectives are not mutually supportive.

Both the perspectives view learning as a dynamic process where students construct new ideas and skills and reconstruct previous knowledge through interactions with their environment including their social environment.

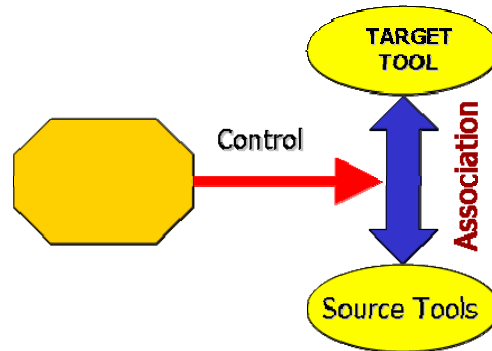
### ***Transfer of Learning***

An overview of relevant literature in transfer of learning was presented in Chapter 2. Here, I focus specifically on the aspects most relevant to my study. I adopt a framework for dynamic transfer (Rebello, Zollman et al., 2005) consistent with contemporary perspectives, to investigate how a student interacts with a series of scaffolding activities, with other students and with the teacher-interviewer in the teaching experiment.

Figure 3.1 shows the elements of the two-level dynamic transfer framework. The ‘source tool’ is dormant knowledge activated by the learner while the ‘target tool’ is information that a learner reads out from the external inputs. The associations between the source and target tool constitute transfer. The activation of associations – called “epistemic gaming”(Redish, 2004) -- is mediated by the learner’s epistemic state.



**Figure 3.1: The transfer framework**



## **3.6 Selecting Research Tools**

### ***3.6.1 Phenomenography***

Phenomenography aims to describe phenomena and focuses on the understanding and variations of experience within a social context. Phenomenographers study conceptions of the world and the distinctly different ways in which individuals understand, experience and interpret social phenomena (Holloway, 1997, p. 116) . In the end, the researcher presents the results in terms of the similarities and differences in relation to how a phenomenon is perceived by individuals.

Bowden (1995) distinguishes between pure phenomenography and developmental phenomenography. The original work of Marton (1981) is referred to as pure phenomenography because of its broad focus on phenomena confronted by subjects in their everyday life. On the other hand, a phenomenographic research with a narrower focus on learning and teaching a concept utilizes developmental phenomenography. The insights from the research outcomes can help in the planning of learning experiences which will lead students to a more powerful understanding of the phenomenon under study. Developmental phenomenography is consistent with the aims of the teaching interview discussed above.

In accessing the mental models of students about microscopic friction I used a phenomenographic approach. Mental models according to Johnson-Laird 1983 “are structural analogues of the world as perceived or conceptualized by individuals.” Meanwhile, Gentner and Stevens 1983 argue that “mental models are related to human knowledge of the world and of how it works i.e., the way people understand some domain of knowledge.” From Gilbert and

Boulter 1998 perspective, a model is a “representation of a target which might be an object, event, process or system.” Vosniadou 1994) believes that “mental models refer to a special kind of mental representation, an analog representation, which individuals generate during cognitive functioning.”

In this research I am defining mental models as students’ way of understanding a certain physical phenomenon —microscopic friction. I believe that students construct these models *in vivo* while answering questions during an interview -- predicting and explaining why a system behaves in a particular way in a given context. This framework is consistent with that of Franco and Colinvaux (2000), Vosniadou (1994); Gentner and Stevens (1983) and Rouse and Morris (1986). The use of a phenomenographic approach, made me capture the meaning and essence of the phenomenon under study as perceived or experienced by the student-participants. In essence the phenomenographic research approach provided me a means of looking at the variations in the mental models of students.

In making the data generated more manageable, I adopted Colaizzi’s (in Cohen and Manion, 1994) seven steps of phenomenological analysis:

1. Researchers review the collected data and become familiar with it. Through this process they gain a feeling for the subject’s **inherent meanings**.
2. Researchers return to the data and focus on those aspects that are seen as most important to the phenomena being studied. From the data they **extract significant statements**.
3. The researcher takes each significant statement and **formulates meaning** in the context of the subject’s own terms.
4. The meanings from a number of interviews are grouped or organised in a **cluster of themes**. This step reveals common patterns or trends in the data.
5. A detailed, analytic description is compiled of the subject’s feelings and ideas on each theme. This is called an **exhaustive description**.
6. The researcher identifies the **fundamental structure** for each exhaustive description.
7. The findings are taken back to the subjects who check to see if the researcher has omitted anything. This is called a **member check**

### ***3.6.2 Credibility***

Lincoln and Guba (1986) identify credibility as the criterion for validity in qualitative research as opposed to internal validity in post-positivist research. In qualitative research, the credibility test asks if there is a correspondence between the way the respondents actually perceive social constructs and the way the researcher portrays their viewpoints. (Mertens, 2005)

Mertens (2005) identifies several strategies in ensuring credibility of researchers' interpretations of the perceptions of individuals of a given phenomenon – prolonged and substantial engagement, persistent observation, peer debriefing, negative case analysis, progressive subjectivity, member checks and triangulation. I present below the different strategies that I employed in my study.

#### ***Triangulation***

Triangulation involves checking information that has been collected from different sources or methods for consistency of evidence across sources of data (Mertens, 2005). The basic purpose of it is to ensure validity of interpretations of evidence. In this study I used two of the six triangulation techniques proposed by Denzin (1989). The two techniques of triangulation that were used in this study are discussed below.

#### ***Member Checks***

To increase credibility of interpretations, a researcher must verify with the respondent groups the constructions that are developed as a result of data collected and analyzed. At the end of the interview, Mertens (2005) suggests that the researcher summarize what has been said and probe if the notes accurately reflect the person's position. In case of this study, the verification of my interpretation was built in during the interview process. I make a point that participants elaborate on their explanation whenever I feel that there are several ways in which their statements can be interpreted. Also, before each interview session ends, I make students summarize what they have told me during the interview. Since I conducted two interview sessions with each of the participants, I always started out with the second session by having students talk about what they did and said in the previous interview.

### ***Peer Debriefing***

In peer debriefing the researcher engages in discussion with peers of findings, conclusions, analysis and hypotheses. In my research, peer debriefing is implemented as I engage in discussion with my advisor of my analysis, conclusions, and hypotheses. Also, other peers in my research group are in a way involved in the debriefing process during seminar presentations where I talk about my research progress.

### ***3.6.3 Dependability***

According to Guba and Lincoln (1989) dependability is the qualitative parallel to reliability in post-positivist research. Whereas, stability over time is expected in post-positivist paradigm, change is expected in the constructivist paradigm which should be tracked and publicly inspectable (Mertens, 2005). Within this perspective, I have maintained a research plan (presented below) which has evolved in each step of the research process.

Each of the interview sessions of the clinical and teaching interviews conducted were videotaped. The videotaping was essential because of the need to capture the different modes (verbal and non-verbal) in which students convey their explanations of certain aspect of the phenomenon under study. I felt as a researcher that videotaping the clinical and teaching interviews would provide me the most complete and objective record of students' experiences.

The videotaping was set-up in such a way that it was unobtrusive as much as possible. The video camera was set up on a tripod that is located to the side of the interviewees. A television monitor was connected to the video camera and interviewees were asked to briefly look at it before every interview session so as to make them aware of what I am capturing during the interview. To maintain anonymity of the subjects I made sure that their faces don't show up in the video. Basically, the video captures hand gestures, pictorial representations, written and verbal expressions. Appendix A -shows how the interview room was set-up and the other reasons why videotape was chosen over other methods of data collection.

### ***3.6.4 Clinical Interviews***

In Phase I (fact-finding phase) of this research, semi-structured clinical interviews were conducted with participants with various backgrounds. A list of preliminary questions was generated and was pilot tested with a graduate student who had been doing clinical interviews in

order for me to get feedback on whether I was asking the right questions and probing students' answers adequately and appropriately. The initial list of questions was then revised based on the feedback generated. The second version of the protocol was then pilot-tested with two students who have the same background as our target participants. The final version of the interview protocol resulted from the feedback I received from the pilot interviews and the discussion I had with my advisor. Appendix B -shows the initial and final versions of the interview protocol.

The clinical interview protocol consisted of open-ended questions which are of different question types. Questions asked in the interview were of the following types:

- *Descriptive Questions:* Used primarily at the start of each interview or when moving to a new topic. This type of question allows subjects to discuss their experiences in their own words.
- *Structural Questions:* Used to elicit how subjects organize their knowledge. This question type is very important in this study as it encourages the subject to reflect and think metacognitively.
- *Opinion or Value Questions:* Used to determine what the subject thinks about a particular issue or person. This question type was used to elicit the subject's opinions and feelings, not just the 'correct' answer.
- *Probing or Nudging Questions:* Used to elicit information more completely, on a particular topic. This question type was used extensively to follow up responses given by students the previous questions

In the actual interviews I adopted a flexible perspective in the ordering of the questions asked and the depth of probing questions but essentially the major questions asked were the same or very similar in the different sets of interviews.

Results of the fact-finding phase showed that introductory college physics students' mental models of microscopic friction are predominantly influenced by their macroscopic ideas. This result motivated me to move on to investigate the dynamics of students' model construction and reconstruction in developing a better model of friction at the atomic level.

A preliminary list of interview questions that would be used in the second phase of this research was generated based on the results of the clinical interview. Subsequently, I also conducted interviews with content experts in order to establish their present models of friction at the microscopic level. And finally, I reviewed existing literature about microscopic friction.

Results of these processes conducted influenced the development of the protocol in the conduct of the teaching interviews in the second phase of the research.

### ***3.6.5 Clinical Interviews with Experts***

In transitioning from the first phase to the second phase of the research, clinical interviews with experts were conducted. The purpose of the interview was to establish their current models about microscopic friction. A more thorough discussion of the clinical interviews with experts is provided in the next chapter.

### ***3.6.6 Teaching Interviews***

As described previously, I primarily adopted a phenomenographic approach in my data collection and analysis. In looking into the dynamics of students' knowledge construction I specifically used the teaching interview (Engelhardt, Corpuz et al., 2003) as a research methodology. The philosophical basis for this methodology is consistent with the constructivist views of Piaget and Vygotsky as well as the contemporary views of transfer of learning (Bransford, Brown et al., 1999; Greeno, Moore et al. 1993 ; Lobato, 1996)

One of the aims of teaching interview is to provide a bridge between educational research and teaching practice. Cobb & Steffe 1983) assert that the interest of a researcher during the teaching experiment is in generating hypotheses on what a student might learn and finding ways and means of fostering learning in a given context.

The teaching interview is a “mock instruction” setting in which the teacher-researcher influences the knowledge construction process of students by providing pedagogically appropriate scaffoldings. It provides a rich context into which one can study the dynamics of students' knowledge construction and reconstruction as they interact with a learning material, with other students and with the teacher-interviewer. The research outcome from the teaching interview can be used for theory building or the outcome can be used in planning learning experiences for students in helping them understand better a given phenomenon.

In the second phase of my research I conducted teaching interviews in order to investigate dynamics of students' model construction and reconstruction in coming up with a better model of friction at the atomic level. In this phase, scaffolding activities were likewise designed. The initial version of the protocol was pilot tested with several students. An observer was involved in the pilot testing of the protocol. The protocol was then revised based on the

feedback from the students as well as from the observer. **Appendix C** -shows the initial and final versions of the teaching interview protocol. Meanwhile Appendix D -shows a detailed description of the scaffolding activities used in the teaching interviews.

### **3.7 Mapping Appropriate Methodologies, Perspectives, and Research Tools to the Final Research Plan**

The preliminary research plan was then refined and separated into three phases and more details were incorporated. The research plan served as a guide and as a means for communicating the process of my research with other researchers and peers. The preparation of this plan in a way addresses dependability issue of qualitative research. (see **Appendix E** -)

### **3.8 Chapter Summary**

This investigation was done at Kansas State University. The participants of this study were students enrolled in various introductory physics courses. In this chapter the philosophical and methodological perspectives that influenced the choice of the research methodology and research tools are thoroughly discussed. In carrying out the research I was guided by two theoretical constructs – phenomenology and constructivism.

I used a multi-methodological approach in this study. In the Fact-Finding Phase (Phase I) I used a blend of a grounded theory approach and phenomenology. Data were generated from a variety of sources -- students, physics content experts and existing literature. A variety of data collections techniques were used. In Phase II, while examining the dynamics of students' construction and reconstruction of ideas, I used a phenomenological approach. Phase II culminated with the development of an instructional module and assessment tasks. Finally, in Phase III, I used an approach similar to that used in action research to evaluate the developed instructional module in the classroom.

A discussion of four assumptions that a researcher makes in order to understand social reality and research are provided in this chapter. These assumptions gave me a better sense of how I should approach my research in general. Since this research is qualitative in nature, different aspects of credibility and dependability were further presented in this chapter including triangulation, member-check and peer-debriefing.

Clinical interviews were used in order to investigate students' existing mental models about microscopic friction. Meanwhile teaching interviews were primarily used to investigate

the processes in which students dynamically construct their ideas. Individual teaching interviews were conducted in order to establish the variations in students' conceptual trajectories as they were provided with different scaffolding activities. Group teaching interviews were conducted in order to investigate the social aspect of students' knowledge construction. The chapter concluded with a presentation of the final research plan which guided me throughout the study.



## **CHAPTER 4 - Phase I – Students’ Mental Models**

### **4.1 Introduction**

This chapter describes the fact-finding phase of the project. The primary goal here was to investigate students’ mental model of microscopic friction. The data gathering and analysis procedures and various sources of data are presented in this chapter. The chapter concludes with a presentation of the variations in students’ mental models and how the findings of the study feed into the second phase of the research.

### **4.2 Methodological Overview**

In the fact-finding phase of the research, a grounded theory approach was used first to establish students’ initial mental models about microscopic friction and later to determine the target models that would help students construct through instruction.

In keeping with the grounded theory I approached the research task with no prior hypothesis about students’ mental models of microscopic friction or about the target models that would be appropriate for these students to construct. I cast a wide net to gather data from a variety of sources. Data emanated from conducting clinical interviews with introductory college physics students. I also interviewed and surveyed experts in the field of nanoscience research and examined existing instructional resources in the area of microscopic friction.

### **4.3 Data Gathering Procedures**

The purpose of the fact-finding phase of this research is to investigate the variations in students’ mental models about microscopic friction and also to establish a target model that I aim for students to construct through the instructional experiences. This section provides details on the data gathering procedures used to address this issue.

#### ***4.3.1 Clinical Interviews***

In order to elicit students’ mental models of microscopic friction, two one-hour semi-structured clinical interviews were conducted per student. The interview sessions were

videotaped with permission from the students. The clinical interview conducted with the students is loosely structured and conversational in its nature. The conversational style allowed me to talk to the interviewees in a more natural and less threatening way than a more structured format. The loosely structured, conversational format appeared to make students more willing to speak out what they were thinking at the spur of the moment.

At the beginning of the first interview session, the interviewer (I) discussed with students issues about confidentiality of the interview data, purpose of the interview, data collection procedures (videotaping and audio taping) and how data will be used. The conditions of informed consent as required by the KSU Institutional Review Board on Human Subjects were clearly explained to the students. Students were asked to read the informed consent form (Appendix F -) and sign it if the conditions were acceptable to them. They were also told that they had the right to withdraw from the process at any time, without any penalty.

In addition to the requirements of the KSU IRB informed consent form, students were explicitly reminded that there were no right or wrong answers in the interview. They were also told that the purpose of the interview was to explore their thinking as it occurred and that it was acceptable to “make things up” as they went along. This was deliberately done in order to encourage them to be more open and comfortable during the interview. They were also told that in some cases they could be asked follow-up questions based on their responses, and that these follow-up questions did not necessarily mean that their answer was either correct or incorrect, rather it was only an attempt by the interviewer to gain deeper insights into their thinking and reasoning processes. Up to the first five minutes of the interview were spent on clarifying the aforementioned points to the interviewee. This part of the conversation seemed to make students more comfortable to speak freely regarding their thoughts about the phenomenon in focus.

The interview protocol was pilot-tested with a graduate student and two undergraduate students (one life science major and one engineering major). The initial version of the protocol was then revised based on their feedback. The final version of the protocol contained questions addressing the following issues:

- Surfaces at different length scales
- cause of friction at the atomic level
- differences between kinetic and static friction
- lubricating mechanism of oil

- effect of surface roughness on friction

Several model-eliciting activities (Lesh & Kelly, 2000) aided the interviewer in probing the students' mental models of friction. These activities include having students slide their fingers across a wooden surface, dragging a wooden block across a wooden surface then across a surface with sandpaper, sketching how surfaces would look to them at the atomic level.

Follow-up and probing questions were also asked during the interview and these were quite different with each student. The probing questions in the clinical interviews were based on students' predictions and explanations during the different model-eliciting activities.

The first interview session focused on establishing students' explanations of surfaces at different length scales, the cause of friction at the atomic level and similarities and differences between kinetic and static friction. The second interview session, which occurred a day or two after the first session, focused on students' explanations of the lubricating mechanism of oil and variation of friction with surface roughness. Throughout these interviews students were requested to explain their ideas in words as well as through diagrams and sketches. The use of multiple representations of students' ideas often provided opportunities for further probing questions.

As a way of increasing the dependability (Guba, 1989) of the data collected, I asked students to summarize before the end of the interview their explanations of the different model-eliciting activities. The second interview session began by having students recall what they had done and said in the previous interview session. It is worth noting that all of the students whom I interviewed were able to accurately recall what they did and said during the first session.

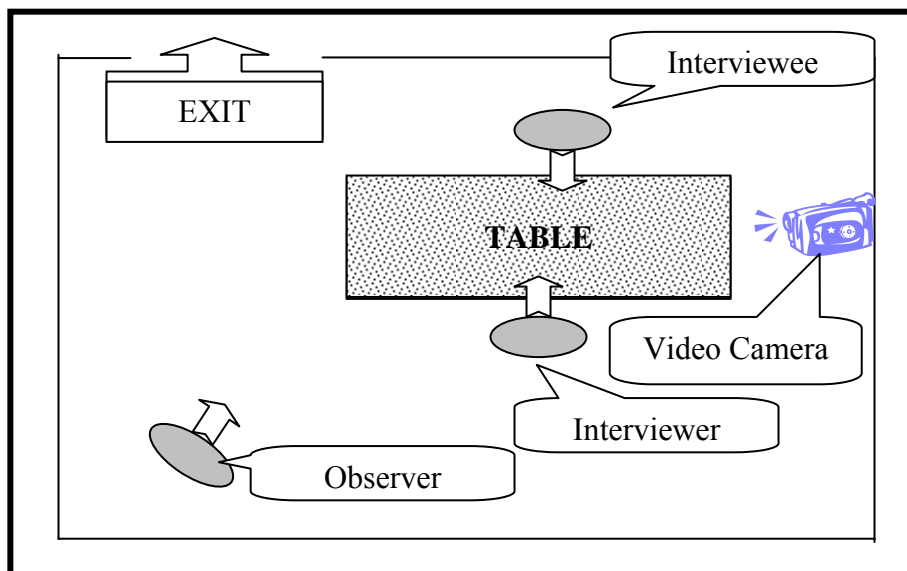
A total of 11 students enrolled in Contemporary Physics course in spring 2004 were interviewed. Almost all students were life-science majors and already had instruction on atoms in previous science classes. Table 4-1 shows the distribution of students with respect to their majors.

**Table 4-1: The Informants**

<b>Major</b>	<b>No. of Students</b>
Mechanical Engineering	<b>4</b>
Secondary Education	<b>3</b>
Marketing	<b>1</b>
Computer Science	<b>1</b>
Microbiology	<b>1</b>
Undecided	<b>1</b>
<b>Total</b>	<b>11</b>

Patton (1990) stresses the importance of recording the raw data during an interview as completely as possible from the perspective of the interviewee. Since the raw data from my research not only come from direct quotations from the interviewees but also from their written responses and gestures responses as well, the use of videotaping seems to be an indispensable means of recording the data.

**Figure 4.1. The interview room**



Through the use of the videotape, the burden of making field notes on the part of the interviewer is being addressed. Since I did not have to take notes all throughout the interview I was able to better maintain the conversational style during the interview. Moreover, I was able

to give my full attention to the interviewee and I was able to better formulate questions to probe deeper into what the interviewee was saying at a particular instant.

## **4.5 Data Analysis**

A phenomenographic approach of analysis (Marton 1986; Svensson and Theman, 1983) as per which students' responses are grouped into naturally occurring categories based on their quotes and excerpts. The inter-rater reliability of the categorization was established by having two other experts do the categorization independently. A second layer of thematic analysis combined the categories of responses in different contexts in the interview to generate themes.

## **4.6 Students' Mental Models: Descriptions of Phenomena**

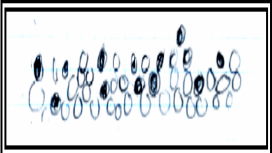
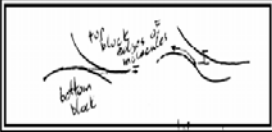
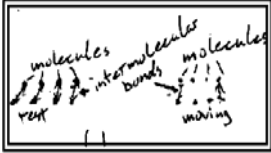
Students were provided a set of experiences such as dragging a block on a wooden plank and other surfaces. They were asked to explain what they observed. In other cases, students were not provided a direct experience of the phenomenon (e.g. lubrication) but were asked to explain the physical reasoning underlying the phenomenon. In either case students' responses were analyzed to ascertain their mental models

### ***4.6.1 Cause of Friction at the Atomic Level***

Students were asked to pull a wooden block over a plank. Interviewees talked about friction when explaining why they needed a finite force to start the block moving. Follow-up questions were used to probe students' ideas about the causes of friction at the atomic level.

Table 4-2 summarizes the variations in students' models and provides a representative quote and sketch explaining the microscopic model. A majority of the students used the intertwining/interlocking and rubbing/sliding model to explain microscopic friction. An inter-rater reliability of at least 80% was established by comparing my coding with the coding by two other experts.

**Table 4-2. Models Explaining Static Friction**

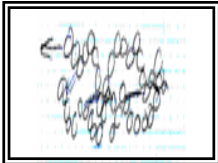
	<b>MODELS</b>		
	<b>Intertwining / Interlocking</b>	<b>Rubbing/Sliding</b>	<b>Breaking of Bonds</b>
<b>Model Description</b>	Friction is the force needed to pull an atom over the bumps due to intertwining or interlocking of atoms.	Friction is the rubbing or sliding of an atom past another atom.	Friction is the force needed to break the bonds between atoms of surfaces that come into contact.
<b>Sample Sketch</b>	The atoms of the wooden block (shaded) interlock with the atoms of the tabletop (not shaded). 	The atoms of the wooden block rub against the atoms of the tabletop. 	The atoms of the wooden block bond together with the atoms of the tabletop. 
<b>Sample Quote</b>	<i>“When you set it [the block] on top, it kind of settles in like goes into a neutral energy state. When I try to move it I got to pull them out so there will be some friction because there will be some particles getting intertwined (fingers of hand intertwining).”</i>	<i>“They (atoms) don’t mesh together at all. They just sit on top of one another...they are touching but they don’t interact any more than just the physical contact... one of them is moving and one of them isn’t moving so they rub together.”</i>	<i>“Well I would say friction is the bond between the atoms. I don’t know if that’s electronic or ionic bonding.”</i>
<b># of Students</b>	5 students	5 students*	3 students*

\*Two students simultaneously used the rubbing/hitting and breaking of bonds model

### 4.6.2 Why Static Friction is Greater than Kinetic Friction

In explaining why static friction is greater than kinetic friction, a majority of the students used skimming through the top model. Table 4-3 summarizes all of the models used by students to explain this observation.

**Table 4-3. Models Explaining Kinetic Friction**

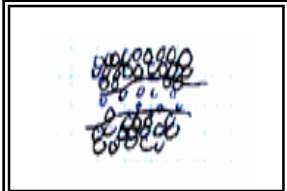
	<b>MODELS</b>			
	<b>Skimming Over the Top</b>	<b>Changing Downward Force</b>	<b>Getting Smoother</b>	<b>Fewer Bonds</b>
Model Description	Once the block has started moving, the atoms of the block just skim over the atoms of the other surface.	When an object starts to move the downward force decreases.	The surface would somehow get smoother once we started moving one of the surfaces relative to the other.	There are fewer bonds to break once the objects move relative to each other.
Sample Quote & Sketch	<p><i>“When you’re moving it, they’re gonna be not as intertwined.”</i></p> 	<p><i>“When it is at rest there’s more pressure between the atoms... when it starts moving, you have less force pulling down.”</i></p>	<p><i>“The way this works basically is, it is more rough when it wasn’t moving than when it was.”</i></p>	<p><i>“...they might not have enough time to form that (bond)... So there’s less number of bonds to be broken.”</i></p>
# of Students	5 students	1 student	1 student	2 students



### 4.6.3 Lubricating Mechanism of Oil

The two most dominant models (see Table 4-4) that students used in explaining how oil reduces friction are the ball bearing and floating models. A majority of the students think that oil atoms reduce friction in a way analogous to ball bearings or that they provide a floating barrier for the upper surface.

**Table 4-4. Models Explaining the Lubricating Mechanism of Oil**

	<b>MODELS</b>			
	<b>Ball Bearing Model</b>	<b>Weaker Bonds</b>	<b>Reduction of Bumps and Valleys</b>	<b>Floating Model</b>
Model Description	Oil reduces friction just like ball bearings.	With oil in between the surfaces, there is a weaker bond to break.	The atoms of the oil reduce the bumps and valleys thereby reducing resistance to movement.	Atoms of oil provide a floating barrier for the atoms of the wooden block.
Sample Quote & Sketch	<i>“I think it might be possible that they move past one another easier, but it could be that maybe oil molecules roll.”</i>	<i>“... they don’t exhibit as much intermolecular bonds between each oil molecule than between oil and wood molecules so they can move past one another easier than the wood on wood.”</i>	<i>“Oil is not solid in a sense makes it a lot more flat to where nothing can stick out and go against stuff as it went by.”</i>	<i>“Oil will help separate these bumps and valleys such that they don’t have to interact with the full scale.”</i> 
# of Students	5 students	1 student	2 students*	5 students*

\*One student simultaneously used reduction of bumps and valleys and floating model.

## **4.7 Students' Mental Models: Emergent Themes**

Two overarching themes emerged from the second layer of analysis of the variations in the students' models of friction and lubrication: mechanical interactions and chemical interactions.

### ***4.7.1 Mechanical Interactions***

The thematic analysis revealed the persistence of students' responses that friction is simply due to mechanical interactions of the atoms. At least 80% of the students appeared to hold this view. When they were asked to explain what causes microscopic friction most students alluded to the interlocking/intertwining or rubbing/hitting model. For these students friction is either the force needed to pull an atom over the bumps due to intertwining/interlocking of atoms or the force due to the rubbing/sliding of an atom past another atom. When the five students with the interlocking model were asked what happens if the surfaces become atomically smooth they said that friction persists because atoms still physically rub against each other. Similarly, when students were asked to explain why oil reduces friction almost all of them likened the oil to ball bearings rolling on a surface. These explanations of friction and lubrication are clearly based on the idea of mechanical interactions. All of these responses are consistent with the notion that friction is due to mechanical interactions between atoms.

### ***4.7.2 Bonding***

The thematic analysis also revealed another theme. For three of the students, microscopic friction is the force needed to break the bonds between the atoms of surfaces that come into contact. When these students were asked to explain why kinetic friction is less than static friction they think that there are fewer bonds to break once the other surface is set in motion. Similarly when asked to explain what happens when there is oil in between two surfaces, one of these students believed that friction is reduced because it's the weaker bond between oil and wood that needs to be broken instead of the bond between wood and wood. All of these responses are consistent with the notion that friction is due to the bonds between the atoms.

#### **4.8 Students' Mental Models: Overall Findings**

Through clinical interviews with students I found that most of the students hold onto the idea that friction at the atomic level is simply due to mechanical interactions. This is evident from the models used by students in explaining why static friction is greater than kinetic friction as well as the lubricating mechanism of oil. When students were asked to sketch how the smoothest surface would look at the atomic level, they often drew atoms lining up. When asked if there was still friction when two such surfaces come into contact and move past one another, I often heard students say, “*There will still be friction because there is still some contour in them (atoms.)*” Only one student cited electrical interactions as a possible source of friction. Thus, for most students, what is true macroscopically must also be true microscopically.

#### **4.9 Development of Preliminary Teaching Interview Protocol**

The aforementioned findings motivated me to do further research on how students can be helped to improve their present models of friction. In this context, I decided to conduct teaching interviews with introductory physics students with the aim of studying the dynamics of their model construction as they interact with scaffolding activities. These scaffolding activities are geared to facilitating model construction and reconstruction among students in order to help them construct more scientific models of microscopic friction.

The study of microscopic friction is an emerging area, and unlike areas of physics that are typically addressed in an undergraduate physics curriculum, these ideas are still being developed by experts. Therefore it was important to determine what ideas were prevalent among experts in the area. There have also been some advances in the teaching of microscopic friction. It was also important for me to examine the models used in literature as well as models that have been used by others for instruction. Knowledge of all of these issues was critical to developing the teaching interview protocol, which would later serve as a pre-cursor to the instructional module and assessment tasks that was the outcome of this project. Thus, I both investigated the views of experts in microscopic friction as well as examined existing literature in this area.

### ***4.9.1 Expert Interviews & Surveys***

Clinical interviews with content experts were conducted to establish the models that they presently hold about friction. Textbooks, research journals and websites were likewise reviewed to have a sense of the different models that are used to explain friction at the atomic level.

Cross comparison of the models generated from the interviews with students, interviews and surveys with experts and literature review, was done to come up with the target ideas for the teaching interviews.

Four (4) experts from the physics department of Kansas State University volunteered to be resource persons. Two of them are professors in physics who had been teaching introductory college physics for several years. One of them has conducted and published research on the interactions, structure and dynamics at liquid surfaces while the other content expert has been conducting and publishing research in the area of atomistic modeling of materials, especially surfaces. The other two resource persons were post doctoral students who have been doing research in the area of the physics of surface phenomena.

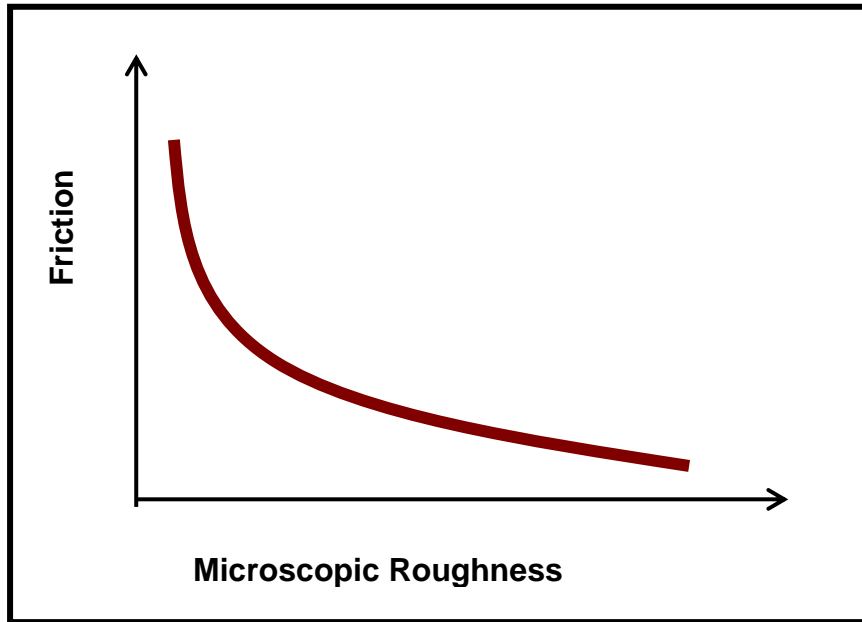
One of the difficulties I encountered was recruiting experts from outside of the physics department of Kansas State. Several experts carrying out research on nanotribology were contacted but unfortunately only one of them responded. A survey questionnaire (Appendix G -) was e-mailed to this individual.

A phenomenographic approach (Marton, 1986) of data analysis was used in order to make sense of the data collected during the interview with experts. Quotes or excerpts seen as representing particular meanings were selected from the transcript of the interview. The categories of their explanations emerged from conducting a second layer of analysis of the selected quotes.

The models that the experts used in explaining the cause of friction at the atomic level and also the relation between friction and the surface roughness, were the following:

- Friction is due to surface atoms (charge density) rearrangements.
- Friction is due to phonons and electronic contributions.
- Friction is caused by plastic/elastic deformations of asperities.
- Friction varies with microscopic roughness as shown in Figure 4.2.

**Figure 4.2. Variation of force of friction with microscopic roughness**



#### ***4.9.2 Examination of Models in Literature***

Almost all introductory physics texts cover the topic of friction. The force of friction is given by the expression:

$$f = \mu N \quad (4.1)$$

where:

$\mu$  represents the coefficient of friction between the two surfaces, and  $N$  represents the force of normal reaction between the two surfaces.

Robins and Ringlein (2004) have suggested a modification to (4.1) above. They argue that a more accurate description of friction at the nanoscale is given by

$$f = \mu N + cA \quad (4.2)$$

where:

$c$  represents the force needed to dislodge each atom from its potential energy minimum in the absence of an external load

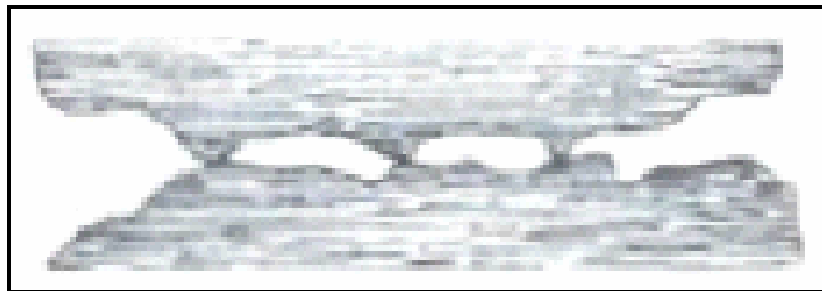
A represents the area where the atoms on opposing surfaces are close enough that they interact strongly.

In general, in this model, the term 'cA' increases as surfaces are made smoother while the term  $\mu N$  increases as surfaces become rougher. Because these two factors behave oppositely with increasing surface roughness, there is an optimum level of roughness that minimizes friction.

Swartz and Miner (1997) in their book “*Teaching Introductory Physics: A sourcebook*” explained friction in terms of the “spot welds model” or “molecular bonding model”. In this model dry friction is caused by the breaking of large number of tiny spot welds that are continually made as two objects are pressed together and slide over each other.

Figure 4.3 describes how weight is supported by many micro ridges between two surfaces. Some of these micro ridges are crushed due to the weight of the upper object, causing the metal to flow and form welds.

**Figure 4.3. Weight is supported by many micro regions**



For non-deformable objects friction is *independent* of the *apparent surface area* because under most circumstances the actual area bearing the load is much smaller than the apparent area as seen in Figure 4.3 above. The *actual contact area* is always *proportional to the applied (normal) force* when the coefficient of friction  $\mu \leq 1$ . However, for freshly milled surfaces of hard metals, under vacuum conditions, both the coefficient of static friction,  $\mu_s$  and the coefficient of kinetic friction,  $\mu_k$  can be larger than 1. This phenomenon can be explained in terms of the molecular bonding model.

One of the models used by nanotribologists in explaining and understanding atomic friction is the Tomlinson (1929) model. In this model friction is explained in terms of a

mechanism based upon the occurrence of unstable equilibrium positions of atoms in a conservative potential. The model is discussed in greater detail in Chapter 2.

Overall, I found that there were several models that researchers use to describe microscopic friction. In examining these models, however, I also had to consider our students' level of intellectual development and prior knowledge in mathematics and sciences, as well as their familiarity with certain representations and analogies. Based on all of these considerations, I found that most of the models discussed above were not appropriate for our target audience, which could include students with no prior background in physics. Therefore, I excluded all but the model proposed by Robbins and Ringlein (2004). This model was an extension of the model that is typically presented to students in their introductory college physics texts. Yet, the model by Robbins and Ringlein also captures some useful insights about microscopic friction.

### ***4.9.3 Establishing Target Ideas for Students***

Based on results of the clinical interviews with students, interviews with experts and literature survey, the following aspects of microscopic friction were adopted as the target ideas that I would aim for students to acquire through the teaching interviews:

The target ideas are:

- Friction is due to electrical adhesion of atoms.
- Friction is dependent on the atomic contact area.
- Friction on atomically smooth surfaces is large.
- Friction varies with roughness as in Figure 4.4.
- Atomic friction is described by the equation

$$f = \mu N + cA \quad (4.2)$$

Where

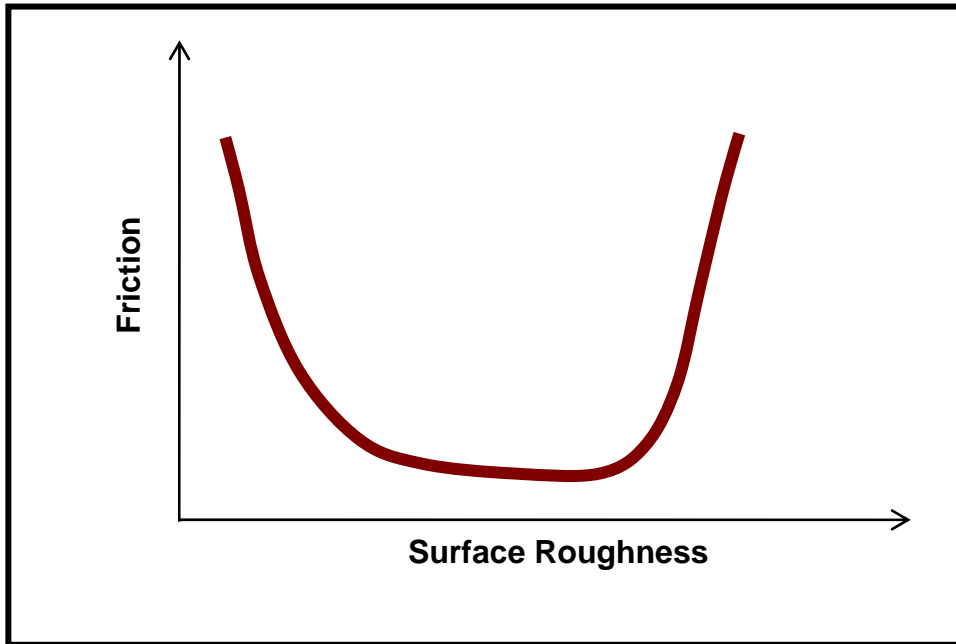
‘ $\mu$ ’ is the coefficient of friction

‘ $N$ ’ is the force of normal reaction on the surface

‘ $c$ ’ is the force needed to dislodge each atom.

‘ $A$ ’ is the number of atoms.

**Figure 4.4. Target Model of Friction vs. Surface Roughness**



The graphical representation of the target ideas depicted in Figure 4.4 shows that force of friction is extremely large when the surface roughness increases. The force of friction also becomes very large when the surfaces are extremely smooth.

The model represented in Figure 4.4 is consistent with the model by Robbins and Ringlein (2004) in equation (4.2), in that it accounts for the increase in friction due to force needed to dislodge the atoms (c) when the surfaces are extremely smooth as well the increase in friction due to surface roughness,  $\mu$ .

#### ***4.9.4 Developing the Preliminary Teaching Interview***

The initial set of questions for the teaching interview was primarily based on the series of questions asked during the clinical interview. In the clinical interview the interviewer tried as much as possible to avoid prompting the interviewee and changing his/her initial ideas during the interview. However, in the teaching interviews, questions were asked so that students were prompted to think in a certain way. The way the questions were phrased was modified in a way that they increasingly become leading questions. For example, in sketching surfaces, students were deliberately asked to sketch the surfaces at the atomic level. See Appendix C -for the initial set of questions for the teaching interview.



The preliminary set of scaffolding activities included some of the model-eliciting activities used in the clinical interview. It included the activity of sliding fingers across surfaces and sketching them at the atomic level, the dragging a wooden block across a wooden and sandpaper surfaces.

Thus the Teaching Interview was a natural outgrowth of the Clinical Interview conducted in Phase I. In the next chapter we describe the Teaching Interview protocol and results in greater detail. I will describe students' reasoning processes during the teaching interview and how they arrived at the target ideas outlined at the end of Phase I.

#### **4.10 Chapter Summary**

In this chapter the research questions, methodology, data gathering procedures, and the results of the first phase of the study are discussed. The first phase of the study is an investigation of the existing mental models of students regarding friction and lubrication.

Clinical interviews were conducted with eleven (11) Contemporary Physics students in order to elicit their mental models. A phenomenographic approach of data analysis was conducted in order to establish the variations in the mental models of the students.

Furthermore, I also interviewed content experts and conducted a thorough survey of literature to understand the models that scientists typically used to explain microscopic friction. Keeping in view the students' naïve models as well as the ones employed by experts, I arrived at a set of target ideas or models that I concluded were appropriate goals for student learning. These target ideas, after validation by a set of educational and content experts, were used in carrying out the second phase of the research.

Based on the analysis of data from the clinical interviews conducted,, three (3) variations were noted in students' models in explaining friction at the atomic level- interlocking/intertwining model; rubbing/sliding of atoms and breaking of bonds model. In the "interlocking model", friction is the force needed to pull an atom over the bumps due to mechanical intertwining or interlocking of atoms. In the rubbing/sliding model, friction is produced by the rubbing or sliding of an atom past another atom. Lastly, in the "breaking of bonds" model, friction is the force needed to break the bonds between atoms of surfaces that come into contact. A vast majority (at least 80%) of the students used the interlocking/intertwining and the rubbing/hitting of atoms model in their explanations.

A second layer of analysis was conducted in order to generate the underlying themes on students' explanations of microscopic friction. Most of the students hold onto the idea that friction at the atomic level is simply due to *mechanical interactions*. This finding is evident from the models used by students in explaining why static friction is greater than kinetic friction as well as the lubricating mechanism of oil. For most students, what is true macroscopically must also be true microscopically.

This chapter concludes with a discussion of the processes undertaken in the development of the preliminary teaching interview protocol which was used in the second phase of the research.

## **CHAPTER 5 - Phase II: Dynamics of Model Construction**

### **5.1 Introduction**

In the first Phase of the research, I examined the variations in students' mental models of friction at the microscopic level. Results show that although students were able to construct explanations of friction at the atomic scale, they tended to explain phenomena using attributes of macroscopic objects. The overarching theme 'Macroscopic Ideas in Microscopic World' emerged from the analysis of the data. Students were clearly transferring their knowledge based on their macroscopic experiences. These results motivated me to conduct further research that investigates how student learning can be scaffolded to enable them to construct more scientifically appropriate models of microscopic friction based on their previous knowledge and experiences.

In the second phase of the research, I investigated the ways in which students' construction and reconstruction of ideas about microscopic friction can be scaffolded so that they progress toward the target model. Furthermore students' conceptual development was studied as they were provided different scaffolding activities. Based on insights into students' learning trajectories an instructional module was subsequently developed.

Specifically, in this phase I addressed the following questions:

- What scaffolding (cues, hints, activities and other external inputs) causes students to reorganize their knowledge about atomic friction?
- To what extent can students utilize this scaffolding to reorganize and reconstruct their models of atomic friction?
- What are the variations in students' interactions as they go through a series of model-building activities?

The methodologies that were employed to address the aforementioned issues are discussed below. The chapter concludes with a presentation of the results of this phase and discussion of the implications of these results.

## 5.2 Methodology

In this phase of the research I primarily adopted a phenomenographic approach in my data collection and analysis. In looking into the dynamics of students' knowledge construction I used the teaching interview (Engelhardt et. al, 2003) as a research methodology. The philosophical basis for this methodology is consistent with the constructivist views of Piaget (1952) and Vygotsky (1978) as well as the contemporary views of transfer of learning. (Bransford et. al, 1999, Greeno et. al., 1993, Lobato, 1996)

One of the aims of teaching interview is to provide a bridge between educational research and teaching practice. Cobb & Steffe (1983) assert that the interest of a researcher during the teaching experiment is in generating hypotheses on what a student might learn and finding ways and means of fostering learning in a given context.

The teaching interview is a mock instructional setting in which the teacher-researcher influences the knowledge construction process of students by providing pedagogically appropriate scaffolding. It provides a rich context in which one can study the dynamics of students' knowledge construction and reconstruction as they interact with a learning material, with other students and with the teacher-interviewer. It is important to point out that it is not necessarily the goal of the teaching interview to find the optimal, effective teaching methods or the best way to teach students. Rather, it is the goal of the teaching interview to investigate the variations in the trajectories of student learning and the factors that influence these trajectories. The research outcomes from the teaching interview can be used for planning learning experiences for students in helping them understand better a given phenomenon as well as for building our own theory or model of how students learn.

Teaching Interviews were conducted with individual students as well as with groups of students. Individual teaching interviews were conducted to investigate the dynamics of students' knowledge construction and reconstruction as they interact with the scaffolding activities and with the teacher-interviewer. Group teaching interviews were conducted to examine the social aspects of students' knowledge construction and are more in line with Vygotskian ideas of social constructivism. The group teaching interview provides the researcher a scenario which is closer to a real classroom, although this scenario is still quite contrived because unlike a real classroom the teacher-researcher can attend to a single group of students for the entire duration of the

learning experience. As students in groups of two or three work on a task, the researcher's focus is not just on student interactions with the instructional materials but also so on student-student interactions.

### **5.3 Data Gathering Procedures**

In recruiting student-volunteers, the introductory physics course instructors were contacted and a scheme for motivating students -- either paying students \$ 10 per hour or giving them extra credit points in the course in which they were enrolled, to participate in the teaching interviews was worked out. In either case, no attempt was made to select a representative sample of students from the class. Rather the selection of students was based on who volunteered and with whom it was possible to schedule a mutually convenient time to meet.

The preliminary version of the teaching interview protocol consisted of modified questions from the clinical interview. In the clinical interview questions were asked in a way that the interviewer does not influence the interviewee to think in a particular manner or direction. The questions used for the teaching interview included more 'leading-type' of questions (see Appendix C -). The follow-up questions were based on the graduated prompting technique. The interviewer gradually provides successive prompts and hints to the interviewee to help the interviewee respond to the question.

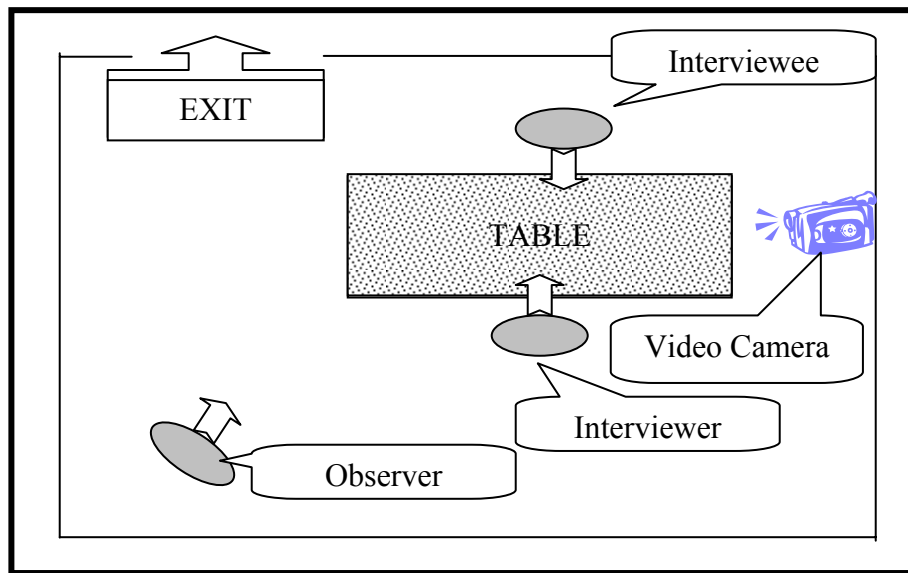
The final version of the teaching interview protocol evolved from doing a series of preliminary individual teaching interviews. In the preliminary teaching interviews the interviewer-researcher experimented with the way in which the questions were phrased and the activities were structured. After successive iterations, eventually the teacher-interviewer figured out the optimal sequence of activities to lead students toward a desired learning objective along a conceptual learning trajectory.

At the end of the teaching interview students were requested to answer a five-minute paper (Appendix H - reflecting on what they had learned in the process. The purpose of this five-minute paper was to provide the researcher another source of data in establishing ideas students generated from doing the teaching interviews. The paper asked students to reflect on what they had learned from the teaching interviews as well as their comments and suggestions regarding the activities.

The initial versions of the teaching interview focused mainly on student-material and student-teacher interactions. The teacher-interviewer deliberately tried to influence students' knowledge construction by constantly providing students scaffolding activities, hints and cues or asking them questions that direct them to reflect on their explanations. Through these preliminary teaching interviews, the teacher-interviewer gained insights into how students construct their explanations which subsequently help him design systematically sequenced scaffolding activities that led students through a targeted conceptual trajectory.

The physical set-up (see Figure 5.1) for the teaching interview is quite similar to that of the clinical interviews that were conducted in phase I of this study. However the two types of interview differed in the way the questions were asked. Questions in the teaching interview were deliberately asked in a way that may lead students to think in a particular manner.

Most of the time, an observer was involved in the individual teaching interviews. Aside from making field notes and helping operate the video camera, the observer takes on an active role by providing additional hints and cues during the teaching interview.



**Figure 5.1: The teaching interview room**

The interviewer usually reminds interviewees to “think aloud” as they perform the activities. Students were explicitly instructed to speak out their “spur of the moment” thinking as they went through the different activities in the teaching interview. They were also told that there was “no right or wrong answer” to the questions, and that the interviewer was not

interested in whether or not they knew the correct answer, but rather their reasoning process. The interviewer also went over the IRB (Institutional Review Board) Guidelines for human subjects. Interviewees were told that their responses would be kept completely confidential. They were told that their interaction here would not in any way affect their grade or academic standing and that they would have the right to leave or withdraw from the process at any time, even after they had provided their written consent. They were also told that, conditional upon their written permission, I would use their data in my research. If their data were reported in journal articles, talks or any other public medium they would not be identified by name, face or voice. I also requested their permission to both videotape and audio tape the teaching interview and showed them that the videotape was not capturing their face or identifying features, but only their hand movements as they worked on the activity. Finally, they were asked if these terms and conditions were acceptable to them, and requested to sign the IRB consent form provided.

## **5.4 Teaching Interviews**

As described in section 5.2, the teaching interview is a “mock instructional” setting in which the teacher-researcher influences the knowledge construction process of students by providing pedagogically appropriate scaffoldings.

The teaching interview helped the interviewer-researcher study in detail how students constructed their knowledge as they progressed through the scaffolding activities. This in turn provided me insights on what scaffolding activities led students to productively construct a certain idea; how these led them through a particular conceptual trajectory; and the optimal sequencing of these activities.

Since the main goal of this phase of the research was to investigate the dynamics of students’ construction *in situ*, the use of the teaching interview was deemed appropriate for it provided the interviewer-researcher an environment which was close to the students’ real learning environment.

### **5.4.1 Individual Teaching Interviews**

Individual teaching interviews were conducted in the summer 2004, fall 2004 and spring 2005. Interviews were deliberately conducted in different semesters so as to involve different streams of students and to give us time to reflect on what I had learned in one semester and apply it to the next semester. Appendix I -shows the demographics of the volunteers. Four (4) of the

participants were currently enrolled in General Physics I (algebra-based mechanics), four (4) were enrolled in General Physics II (algebra-based electricity and magnetism), two (2) were enrolled in Physical World, four (4) were enrolled in Engineering Physics I (calculus-based mechanics) and four (4) were enrolled in Engineering Physics II (calculus-based electricity and magnetism). The volunteers during the summer 2004 and fall 2004 were given extra credit in their physics course for their participation. The volunteers in the spring 2005 were paid \$10 per session.

The teaching interviews consisted of two sessions with each session lasting about an hour. The first session usually started out with the interviewer going over issues of confidentiality, IRB consent forms, and explaining what was going to happen during the interview and how data was being collected and recorded.

The second session which was usually conducted a few days after the first interview session, started out by having students recall what they have done in the previous session. It concluded by having students complete a five-minute paper reflecting on their learning experiences. (see Appendix H -)

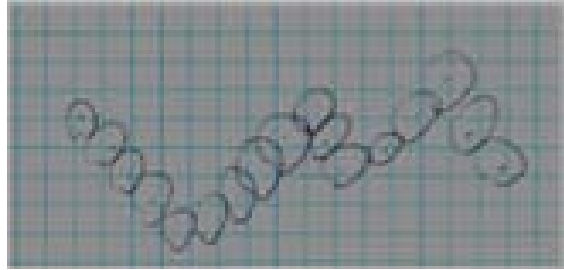
#### ***5.4.2 The Scaffolding Activities***

As the teaching interviews progressed through time, the sessions converged to a protocol that did not deviate significantly from what was used in the previous session. Some of the model-eliciting activities from the clinical interviews were adopted as part of the scaffolding activities for the teaching interviews. These include the following:

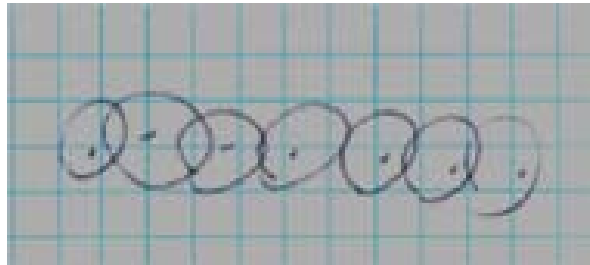
##### ***Activity #1. Feeling and Sketching of Rough & Smooth Surfaces***

In this activity students are asked to slide their fingers across a wooden block surface, the sandpaper surface and the wooden plank surface. Students were then asked to sketch the different surfaces at different length scales down to the level where they presume to see the atoms. Typically students would be making sketches of rough and smooth surfaces as shown in Figures 5.2 and 5.3 respectively.





**Figure 5.2: Sketch of a rough surface**



**Figure 5.3: Sketch of a smooth surface**

***Activity #2. Dragging of Wooden Block across a Wooden Plank and Sandpaper Surface***

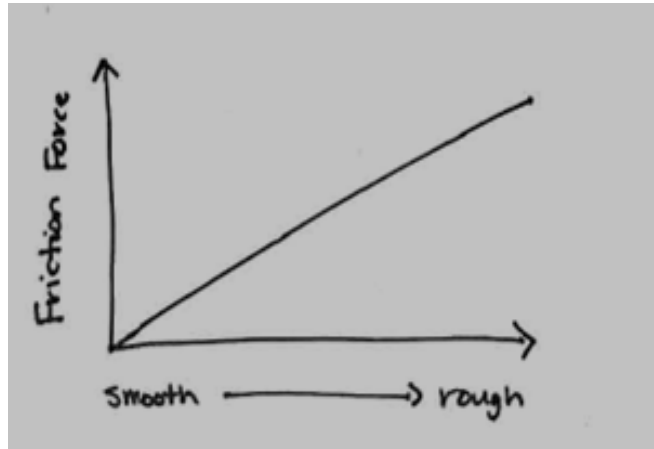
In this activity (see Figure 5.4), students were first asked to predict how the force needed to pull the wooden block across the two different surfaces would compare. They were then asked to give reasons for their predictions before dragging the wooden block across the two different surfaces and describing their observations.



**Figure 5.4: Dragging of wooden block**

### ***Activity #3. Graphing the variation of friction with surface roughness of both surfaces***

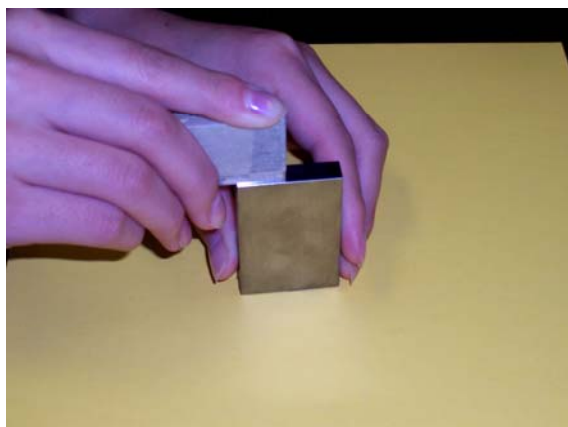
Students were asked to sketch a graph showing how friction force varies with the surface roughness of pairs of sliding surfaces. They were also explicitly asked to explain the details of their graph. Figure 5.5 shows a typical sketch of the students which shows a steadily increasing friction force with surface roughness.



**Figure 5.5: Initial graph of friction force vs. roughness of surfaces**

### ***Activity #4. Metal Block Activity***

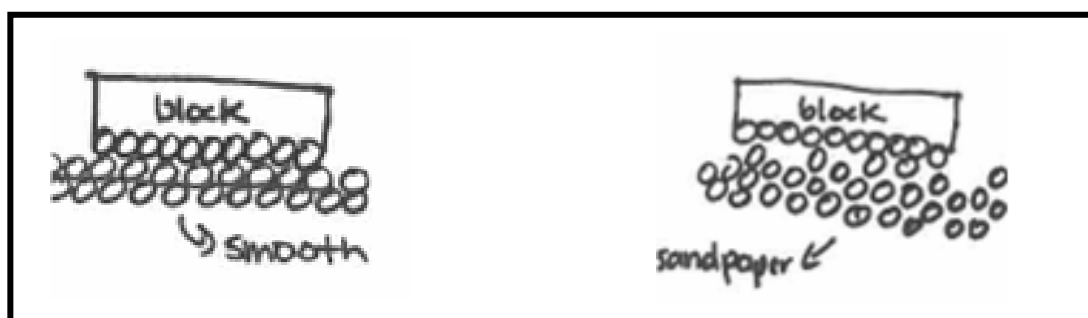
The purpose of this activity was to challenge students' prior ideas about friction. In this activity, students explored friction between a very smooth pair of surfaces of metal blocks and a smooth-rough pair of surfaces of the same metal block (see Figure 5.6). Students were first asked to compare the smoothness of the different surfaces of the metal block by letting them slide their fingernails across the different surfaces. They were then asked to give their prediction and reasons for their predictions of the pair of surfaces for which the friction would be greater. Students tended to predict that there will be more friction between the smooth-rough pair of surfaces because there will be more "interlocking." However, after doing the activity, they would later find out that it would be harder to slide the smooth-smooth pair of surfaces across each other rather than the smooth-rough pair of surfaces. This activity engaged students in cognitive conflict which they mostly resolved through other activities that followed. Through this activity students' current ideas were challenged. This put the students in a mode of considering alternative explanations of friction at the atomic level.



**Figure 5.6: Metal Blocks**

***Activity #5. Sketching the Pairs of Sliding Surfaces at the Atomic Level***

Students were explicitly asked to draw a sketch of the pairs of sliding surfaces at the level at which they could ‘see’ the atoms. The sketches that they drew here were quite similar to what they had sketched previously in Figure 5.2 and Figure 5.3. (i.e. the smooth surface is represented with atoms lining up and rough is represented with atoms in an uneven pattern). This activity provided another context in which students were given the opportunity to reconsider alternative explanations about friction at the atomic level. Figure 5.7 shows a typical response from the students.

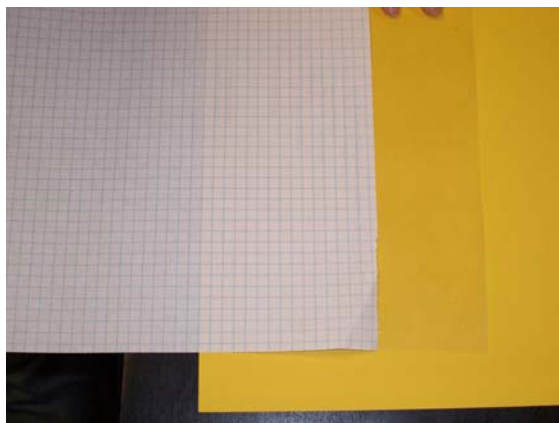


**Figure 5.7: Sketch of pairs of sliding surfaces**

***Activity #6. Paper-Transparency Activity***

Students were provided with a transparency and plane sheet of paper (see Figure 5.8). They were asked to first rub the transparency with fur and then slide the sheet of paper across it. Students typically noticed that they needed to exert a force to pull a flat sheet of paper across the

transparency rubbed with fur. Next they crumpled the sheet same sheet into a ball and after straightening it out they were asked to pull the sheet across the same transparency. Most students noticed that it was much easier to pull the crumpled sheet of paper across the transparency compared to the flat sheet of paper.



**Figure 5.8: Paper over a transparency**

This activity was used to resolve the cognitive conflict brought about by the metal gage block activity. Through this activity students were provided clues to the role of electrical interactions and the real area of contact between two surfaces.

#### ***Activity #7. Sketching of pairs of Sliding surfaces at the Atomic Level***

In this activity students sketched the pairs of sliding surfaces (flat sheet of paper over the transparency and crumpled sheet of paper over the transparency) at the atomic level. This activity was designed to help students reconsider their previous explanations about friction at the atomic level. The activity provides them another context in which they resolve the conflict in the metal gage block activity (#4). By comparing their sketches of the metal block surfaces and the paper and transparency pair students realized how the real area of contact was coming into play in the interactions between the two surfaces.

#### ***Activity #8. Relating the Paper-Transparency Activity with the Metal Blocks Activity***

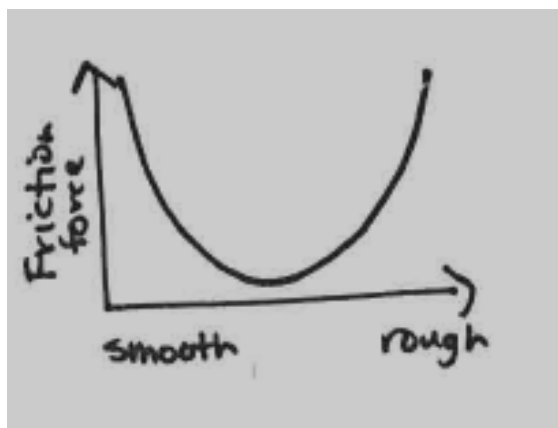
Later in the teaching interview students were explicitly asked to relate their observations in the paper-transparency activity with the metals blocks activity. Through this activity, students came to realize that friction can be large when surfaces become smooth because the real area of contact increases. The real area of contact in this case is not necessarily the visible area of the

surface. Rather it is the sum total of the area of the individual atoms contacting each other. As the real area of contact increases, the electrical interactions between the surfaces become more pronounced.

### ***Activity #9. Revisiting the Friction vs. Roughness Graph***

Students were explicitly directed to go back and make sense of their previous of friction vs. roughness in the light of the new phenomena studied. The purpose of this was to make students reflect on their initial graph and realize that their initial graph was not necessarily consistent in light of the activities that they had just completed.

Also, in this activity the students were explicitly provided the opportunity to revise their initial model how friction varies with the surface roughness and represent this model on the graph of Friction vs. Surface roughness that they had revisited in the previous activity.. A typical response from the students is shown in Figure 5.9.

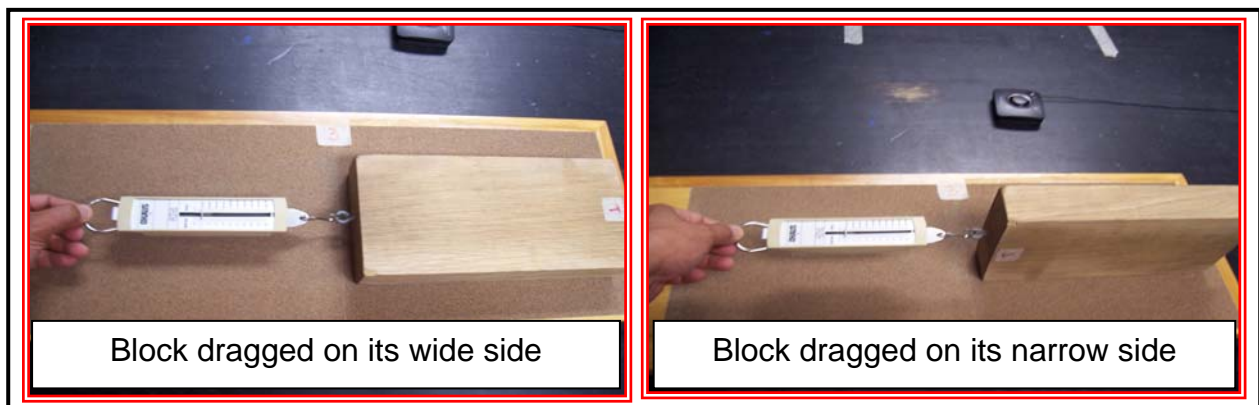


**Figure 5.9: Modified graph of friction force vs. roughness of surfaces**

Students were also asked to describe what happened at the atomic level and the factors that influenced the force of friction. Most students at this point, based on the Paper & Transparency activity (#6) realized that it was the ‘real’ area of contact at the atomic level that determined the force of friction. The crumpled paper and flat paper both had the same area (they were identical), but the flat sheet made contact with the transparency at more points than the crumpled sheet, so it experienced more friction

***Activity #10. Dragging of Block along its wide and Narrow Side***

I again challenged students' ideas regarding the surface area of contact by having them explore the friction when the wooden block is dragged across its wide and then its narrow side (see Figure 5.10). Here, based on their ideas developed above of how friction depended upon real area of contact in the previous activity (#10) students would typically predict that the wooden block dragged along its wide side would experience greater friction. Their prediction would be contradicted by their observation that the force of friction actually ends up being the same regardless of whether the block is on its wide or narrow side.



**Figure 5.10: Block dragged along its wide and narrow sides**

***Activity #11. The Balloon Activity***

In this activity, students modeled the atoms of the surfaces as balloons (see Figure 5.11). Based on the number of atoms on each side of the block, students represented the wide side with more balloons and the narrower side with fewer balloons. Students rested the balloon arrangement on a tray with paint smeared on the surface and then they made sense of what the paint marks on the balloons represented. The paint marks on the balloon are analogous to the real area of contact between the surfaces.



**Figure 5.11: Balloon Activity**

Students noticed that when the box was rested on its wide side (with more number of balloons) the paint marks on each of the balloons were smaller than when the box was rested on its narrower side (with fewer balloons). They realized that this was because in the first case the weight of the box was distributed over more balloons than in the second case, therefore pushing down less on each individual balloon. Thus the contact area made by each atom on the surface would be smaller when the wooden block was rested on its wider side. However, the number of atoms was proportionally larger when the block was rested on its wide side. Students realized that the product of these two factors – the ‘real’ contact area made by an individual atom and the number of atoms in contact equaled out in the two cases, therefore explaining their observation that the force of friction was the same in the two cases.

### ***Activity #12. Mathematical Modeling***

Mathematical modeling was done with some students enrolled in the algebra-based and calculus-based introductory physics courses. Participants enrolled in the conceptual physics-based courses (‘Physical World’ and ‘Concepts of Physics’) did not engage in mathematical modeling.

In this activity students were asked questions that guided them to come up with a mathematical model that could explain the different observations in the teaching interview. The mathematical modeling began with students building on their prior knowledge, typically learned in class, that friction is given by the equation

$$f = \mu N. \quad (5.1)$$

Students were directed to go back to their sketches of the pair of sliding surfaces and have them think about the factors that come into play when talking about friction. Typically students would mention that we need to consider the atom to atom contact and also the interaction of the atom. The teacher-interviewer then proceeded by defining a constant ‘c’ which represented the force that was needed to overcome the electrical interaction between pairs of atoms that came into close contact. Students were subsequently asked how they would figure out the force needed to slide one surface across the other. A typical response would be “just c multiplied by the number of atoms”. The teacher-interviewer denoted the number of atoms with ‘A’. At this point students came up with the expression for the force of friction:

$$f = cA. \quad (5.2)$$

Students were then directed to go back to their U-shaped graph and make sense of the two expressions for the force. They were explicitly asked in which regions each term – ‘ $\mu N$ ’ or ‘cA’ dominated. Typically students would claim that ‘cA’ dominated at the left-hand side of the graph (microscopically smooth) and that ‘ $\mu N$ ’ dominated on the other (rough).side. Students were finally asked if they are to come up with a more general expression for the friction force, what it would be. Most students would automatically say that we simply add the two terms ‘ $\mu N$ ’ and ‘cA’

$$f = \mu N + cA \quad (5.3)$$

Other students ended up multiplying each term, so that:

$$f = (\mu N)(cA) \quad (5.4)$$

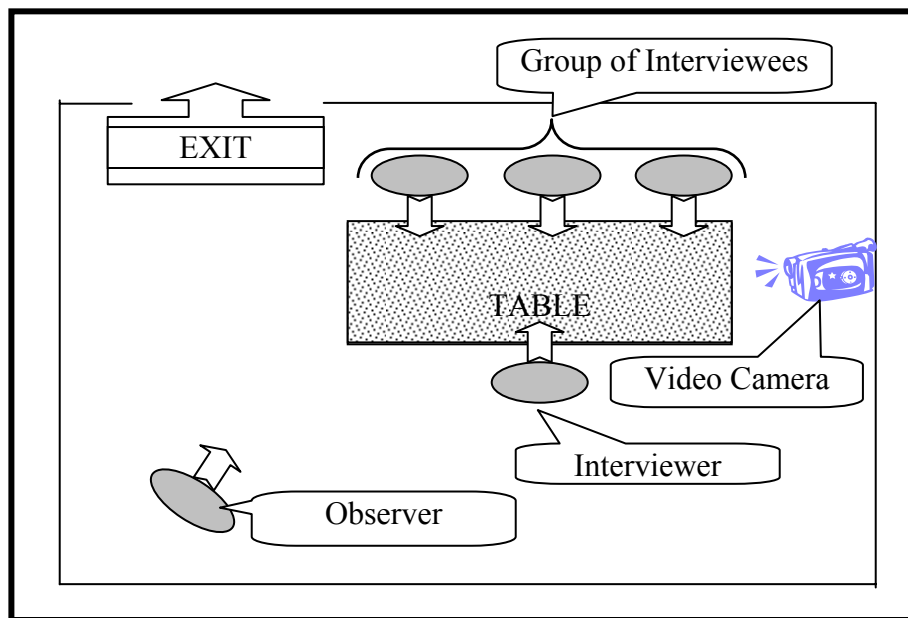
At this point of time I had typically exhausted the allotted one hour for the teaching interview, so rather than resolve the differences between (5.3) and (5.4) above, I used the



remainder of the time to ask students to complete the five-minute reflection paper on the activities they had just completed.

### 5.4.3 Group Teaching Interview

Group teaching interviews were conducted with different sets of students in order to look at how students dynamically construct their ideas while working in groups. Groups of two or three students participated in each of the group teaching interviews. The same sets of scaffolding activities as described in section 5.4.2 were provided to students. The role of the teacher-interviewer was primarily to initiate discussion among students as they try to go through the different scaffolding activities. Figure 5.12 shows the schematic diagram of the group teaching interview room structure. The students in the group sat adjacent to each other all facing the interviewer. While this arrangement was not most conducive toward student-student interaction, it was conducive to the teacher-interviewer interacting with all three students equitably. It was also the most conducive arrangement for videotaping the activities without capturing the faces of any of the students.



**Figure 5.12: Group Teaching Interview Room**

Group teaching interviews were conducted in the summer 2004, fall 2004 and spring 2005. The interviews were deliberately done in different semesters so as to involve different streams of students. Appendix I -shows the demographics of the volunteers. Two groups of the

participants were currently enrolled in General Physics I (algebra-based mechanics), three (3) were enrolled in General Physics II (algebra-based electricity and magnetism), three (3) groups of students were enrolled in Engineering Physics I (calculus-based mechanics) and two (2) groups were enrolled in Engineering Physics II (calculus-based electricity and magnetism). The volunteers during summer 2004 and fall 2004 were given extra credit in their physics course for their participation. The volunteers in spring 2005 were paid \$10 each per session.

## **5.5 Data Analysis Technique**

In making sense of the data generated, I adopted a procedure that is consistent with Colaizzi's phenomenological analysis technique (see Chapter 3.6). Below are the steps that I followed in analysing the data:

1. First I generated the transcripts of each of the teaching interview sessions conducted. The transcript consisted of the verbatim statements, sketches and other written explanations of the interviewees. The transcript also contained the interviewer's questions, hints and prompts. This information was particularly important from the point of a teaching interview since we are interested in how students respond to these hints and cues. The transcription process made me more aware of what Colaizzi refers to as "subject's inherent meanings".
2. From the transcripts, significant statements were then extracted. These significant statements became the focus of subsequent analysis. Again, the extraction of the significant statements was done in light of the questions, hints and cues that were provided by the teacher-interviewer.
3. The researcher sieved through the significant statements using the two-level transfer framework as a guide to determine the 'target tools' (i.e. the information that the students read out from the current situation) and 'source tools' (i.e. the learner's prior knowledge and experiences) associated with them. After identifying the associations the controlling factors were then inferred from the experiences provided during the activities as well as the hints and cues of the instructor. This process was validated by two researchers and discussed until a consensus was reached.
4. I then examined the associations constructed by the students in the different segments of the teaching interview and generated categories of each student's ideas and

models. I also kept track of the extent to which these associations affected the subsequent use in constructing and reconstructing their models of friction at the microscopic level.

5. Themes were then generated by comparing the categories of associations and models across different students or groups of students.
6. A description of each theme was then prepared and was supported by the different associations that students generated.

Since I only had access to the students for a limited time during the interview, I was not able to take back the findings to the subjects for member check. However, in steps 2 through 6 another researcher who is familiar with the goals of the research was involved in cross-checking my analysis. We basically did steps 2 and 6 individually and then we got together to compare our analysis. In cases in which we had disagreements, we engaged in a thorough discussion until we reach a consensus.

## 5.5 Results

In this section the results of the individual and group teaching interviews will be presented. Results from the individual teaching interviews will be presented in terms of the variations of the associations that students make per scaffolding activity as described in section 5.4.2. Moreover, case studies will be presented in order to describe the progression of students' ideas.

Results from the group teaching interview highlight how students in a particular group influenced each other in their knowledge construction. Variations in the associations as well as their consensus associations will be presented (see Appendix J -for sample transcript)

### *5.5.1 Individual Teaching Interview Results & Discussions*

Tables 5-1 to 5-14 depict the variations in the associations between resources made by the students as they went through the different scaffolding activities during the teaching interview.

In Activity # 1, students were asked to feel and sketch both a rough (sandpaper) as well as a smooth (wooden block) surface and sketch the surface at the atomic scale. Students made four different types of associations. As seen in Table 5-1 a vast majority (17 out of 18) of the students that I interviewed associate smooth surfaces with atoms lining up and with rough surfaces having atoms arranged in an up and down manner. Two students (E12, G21) associate smooth surfaces with atoms closer together while one of them (E13) appeared to think otherwise. Yet another student associated surface roughness with sizes of atoms.

In Activity # 2 I asked students to slowly drag a wooden block across a smooth wooden as well as a rough sandpaper surface. In explaining the cause of friction when the wooden block is dragged across the sandpaper surface (see Table 5-2) most of the students used “the catching of ridges” explanation. These students associate friction with the catching of the ridges of the surfaces. According to one of these students:

*“...the ridges are catching on each other. That’s how I would describe it. And in here (wood block over the plank), there’s not much ridge on the smoother surface to catch on so I guess that’s how I will describe it. It’s just the catching of the ridges.”*

In Activity # 3, I asked students to sketch a graph of friction vs. surface roughness. There were four variations on the graph that students generated when they were asked to graph the friction force versus roughness of the sliding surfaces. These variations are depicted in Table 5-3. The first three graphs which were made by almost all of the students depict increasing roughness associated with increasing friction and increasing smoothness associated with decreasing friction. It is interesting to note that one of the students (E23) believed that friction force increases to some point as the roughness increases then it would then decrease. The student believed that as you increase the roughness (from the far left of graph) the friction force will increase because the rougher surface is getting “more grip” but at some point the gripping decreases because of reduced surface area making contact. According to this student

*“...here (left side of graph) it (friction force) is increasing because your rougher surfaces is getting more grip. But at some point your rougher surface will no longer get more grip by digging into it. It also reduces the surface area making in contact. Cause at some point it will look like you’ll have a series of points.”*

In Activity #4 – ‘Metal Blocks Activity’ students were asked to predict which pairs of the metal block surfaces (smooth on smooth or smooth or rough) would be easier to slide over each other. Except for one, they all predicted that there will be more friction in case of the smooth on rough. The variations in their reasoning are depicted in Table 5-4. According to one of the students there will be more friction on the smooth and smooth because of the tendency of the atoms to bond together. The reason that the student made such a prediction is that he previously learned this in his engineering materials course.

After sliding the pairs of surfaces together, students found that it is actually harder to slide the smooth sides together. This activity was designed to create cognitive conflict or disequilibrium in the minds of students in that their predictions are different from their observations. When asked to explain their observations six (6) of the students had no clue on what is happening. The other students tried to resolve the conflict by themselves by using explanations based on previous experiences with magnets and previous explanations in the teaching interview (see Table 5-5). For those students who attempted to explain the phenomena, their explanations were one of the following:

- surfaces are quite similar, so they stick together;

- smooth on smooth are like magnets which attract each other;
- more atoms touch on smooth on smooth, because the smooth sides are curved,
- atoms line up in the smooth on smooth case, so the atoms weld together.

After doing further explorations with other metals students with explanations that the surfaces are magnets later abandoned their explanations and were not able to give further explanations of what is happening.

Activity # 6, the papers and transparency activity was designed to help students resolve the above cognitive conflict and help students construct more plausible explanations for their observations in the metal blocks activity (Activity # 3). It can be seen in Table 5-6 that majority of the students predicted correctly that it will take more force to pull the flat sheet of paper across the transparency. The reasoning resources include the following:

- there would be more static on the flat sheet of paper,
- the uncrumpled paper and the transparency are both flat and thus can connect more,
- there will be more area touching,
- they would behave in the same manner as the smooth on smooth metal surfaces.

Two (2) of the students (E14 & E22) predicted that there will be the same friction in the crumpled and uncrumpled cases; the reason is that they had learned in class that friction does not depend on the area. According to these students friction was simply given by the equation

$$f = \mu N \quad (5.1)$$

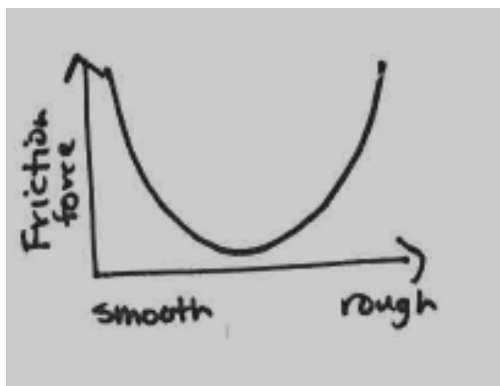
The papers & transparency activity (Activity # 6) helped students recognize the role of the area of contact on the friction force between two surfaces (see Table 5-7). Most of the students explained that in the uncrumpled paper on the transparency there is more area touching which is the reason why there's greater force to pull and hence greater friction between the surfaces. Students with more detailed explanations talked about more charges involved, more atoms touching, and more static effect on the surfaces that have more contact. When asked to relate what they had done with the papers and transparency with what they observed with the metal blocks, students use the following reasoning resources: (see Table 5-8)

more atoms touching on the smooth on smooth so there will be more attraction,

more surface area touching, there will be more charges involved on smooth on smooth sides,

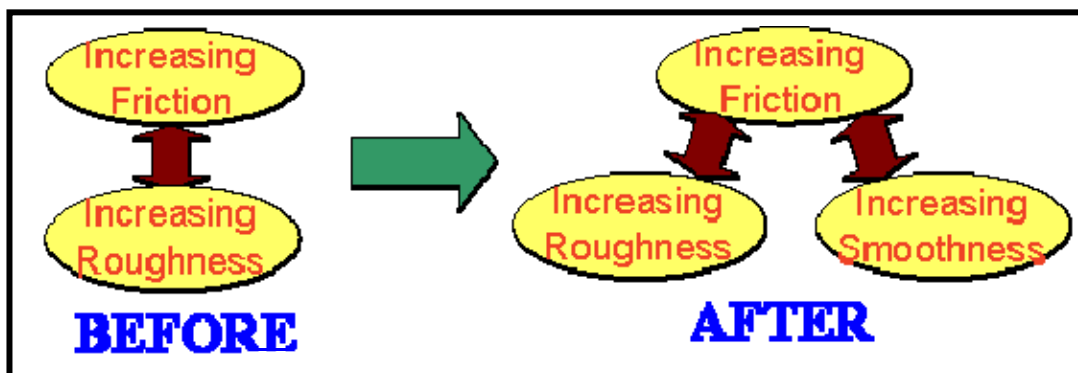
more molecules making contact.

When students were asked if they still go with their previous graph of friction force vs. roughness of the surfaces most of the students would respond in the negative. They would then modify their graph and majority of the students (see Table 5-9) automatically drew a graph similar to the U-shaped graph below:



**Figure 5.13. Modified graph of friction force vs. roughness of the sliding surfaces**

On the right side of the graph students usually talked about the area of contact between charges as the primary reason why the friction becomes high when surfaces become so smooth and when they are very rough the bumps and valleys catch with each other. In coming up with the graph, students are engaged in a process of incremental change as per Wittmann (2006). Initially students associated increasing roughness with increasing friction. They then assimilated the association between increasing smoothness and increasing friction (see Figure 5.14). However, in providing a more detailed description of the modified graph it appeared that students needed to make dual construction (Wittman, 2006), that is they activated two different associations- associations: one association for very smooth surfaces and another association for very rough surfaces.



**Figure 5.14. Knowledge Construction via Incremental Change Process**

Students were then provided another context into which they apply the models that they have constructed so far by doing yet another activity – the dragging of wooden block on its wide and narrow sides. Out of the eighteen (18) students who participated in the teaching interviews only thirteen (13) students were able to complete this activity. In Table 5-10 and Table 5-11, we see the associations that students made as they went through the activity. It can be seen from Table 5-10 that most of the students (9 out of 13) would predict that there will be more friction on the wide side of the block because there will be more contact. Clearly, the students are applying the model that they have constructed so far: the greater the area of contact, the greater the friction.

After doing the activity, students find that the force of friction that they need to overcome is actually about the same on when the block is dragged on its wide or narrow sides. The associations they made in making sense of their observation are depicted in Table 5-11. It is interesting to note that six (6) out of the thirteen (13) students tended to displace their association of friction with the contact area. We could say that the association of friction with contact area is labile at this point in the activity.

The balloon activity was then provided to the students in order to help them resolve the cognitive conflict brought about by the activity on the dragging of the wooden block on its wide and narrow sides. The associations they made were depicted in Table 5-12 and Table 5-13. We can see from Table 5-12 that students would make the association of the balloons with either atoms (11 out of 13) or molecules (2 out of 13). All of the students would make the association that the wide side will have more atoms in contact and that the paint marks is associated with the contact points.



When the students were directed to relate the balloon activity and the wooden block activity, students realized that the total microscopic area of contact on both cases is the same. For most of the students, they would make the association that the wide side has more atoms but the force per atom is smaller compared to the narrow side. Realizing this association further led student to construct the association that fewer atoms but larger force per atom (narrow side) would give the same contact area as the case with more atoms but smaller force per atom (wide side).

Table 5-14 shows the associations that students made as they went through the mathematical modeling activity. In this activity students were asked questions that guided them to come up with a mathematical model that could explain the different observations in the teaching interview. Out of the 18 students who participated in the teaching interview, only 8 out them were able to complete this activity. The reason is that for the ten (10) students, it took them longer to complete the activities prior to the mathematical modeling activity, and because of the lack of time they did not attempt the mathematical modeling activity.

The mathematical modeling began with students building on their prior knowledge, typically learned in class that the force of friction is given by the equation


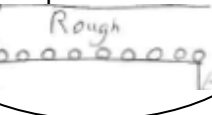

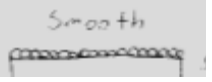
$$f = \mu N. \quad (5.1)$$

Students were directed to go back to their sketches of the pair of sliding surfaces and have them think about the factors that come into play when talking about friction. Typically students would mention that we need to consider the atom to atom contact and also the interaction of the atom. The teacher-interviewer then proceeded by defining a constant ‘c’ which represented the force that was needed to overcome the electrical interaction between pairs of atoms that came into close contact. Students were subsequently asked how they would figure out the force needed to slide one surface across the other. A typical response would be “just c multiplied by the number of atoms”. The teacher-interviewer denoted the number of atoms with ‘A’. At this point students came up with the expression for the force of friction:

$$f = cA. \quad (5.2)$$

Students were then directed to go back to their U-shaped graph and make sense of the two expressions for the force. They were explicitly asked in which regions each term – ‘ $\mu N$ ’ or ‘ $cA$ ’ dominated. Typically students would claim that ‘ $cA$ ’ dominated at the left-hand side of the graph (microscopically smooth) and that ‘ $\mu N$ ’ dominated on the other (rough) side. Students were finally asked if they are to come up with a more general expression for the friction force, what it would be. It can be seen in Table 5-14 that six (6) of the students automatically said that we simply add the two terms ‘ $\mu N$ ’ and ‘ $cA$ ’. One of the students ended up multiplying each term, while another student added the normal force with the term  $cA$  and multiplied the result by  $\mu$  ( $\mu$ ) so that:

**Table 5-1: Associations made by students in Activity #1 (Feeling & Sketching of Surfaces)**

<b>Rough Surfaces</b>			
<i>Association #1</i>	<i>Association #2</i>	<i>Association #3</i>	<i>Association #4</i>
<p>Rough Surface</p> <p>↕</p> <p>Up and Down Arrangement of Atoms</p> 	<p>Rough Surface</p> <p>↕</p> <p>Atoms are more spaced out</p> <p>Rough</p> 	<p>Rough Surface</p> <p>↕</p> <p>Atoms are closer together</p>	<p>Rough Surface</p> <p>↕</p> <p>Differently-sized atoms</p>
PW1,TH, E11, E13, E14,E21, E22,E23,E24,G11,G12,G13,G14, G21, G22,G23,G24	E12	E13	G21
<b>Smooth Surfaces</b>			
<i>Association #1</i>	<i>Association #2</i>	<i>Association #3</i>	
<p>Smooth Surface</p> <p>↕</p> <p>Atoms Line Up</p> 	<p>Smooth Surface</p> <p>↕</p> <p>Atoms are closer together</p> <p>Smooth</p> 	<p>Rough Surface</p> <p>↕</p> <p>Atoms are farther apart</p>	
PW1, PW2, E11, E13, E21, E22, E23, E24, G11, G12,G13, G14, G21, G22, G23,G24	E12, G21	E13	

*Legends:* PW – Physical World G1- General Physics 1 G2- General Physics 2

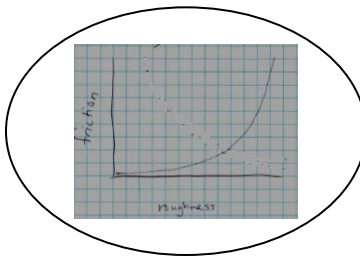
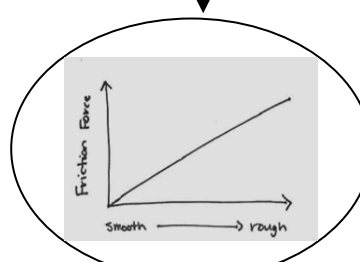
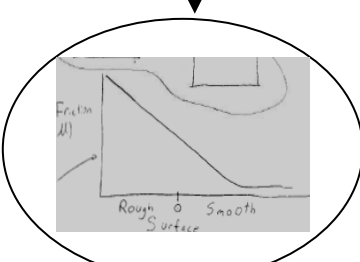
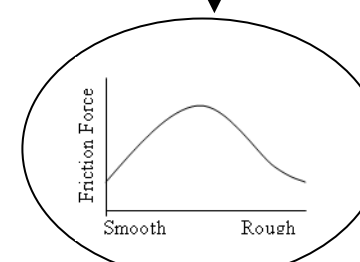
E1 - Engineering Physics 1 E2 – Engineering Physics G11- General Physics 1 Student #1...etc.

**Table 5-2: Variations in the associations made by students in Activity #2 (Dragging of Wooden Block)**

<b>Dragging of Block of Wood (Explanation)</b>		
<i>Association #1</i>	<i>Association #2</i>	<i>Association #3</i>
<pre> graph TD     A([Difference in Friction]) &lt;--&gt; B([Catching of Ridges])         </pre>	<pre> graph TD     A([Sandpaper]) &lt;--&gt; B([Greater Peaks])     A &lt;--&gt; C([More Coarse])     A &lt;--&gt; D([More Jagged])     B &lt;--&gt; E([Greater Friction])     C &lt;--&gt; E     D &lt;--&gt; E         </pre>	<pre> graph TD     A([Wood Block on Sandpaper]) &lt;--&gt; B([More Attractive Force])     B &lt;--&gt; C([More Friction])         </pre>
PW1, PW2, G13,G14, G21, G22, G23, E21 , E23, E24	G11	G24
<i>Association #4</i>	<i>Association #5</i>	<i>Association #6</i>
<pre> graph TD     A([Wood Block on Sandpaper]) &lt;--&gt; B([Atoms Can Get Closer])     B &lt;--&gt; C([More Interaction])     B &lt;--&gt; D([More Friction])         </pre>	<pre> graph TD     A([Wood Block on Sandpaper]) &lt;--&gt; B([Surfaces Grabbing])     B &lt;--&gt; C([More Friction])         </pre>	<pre> graph TD     A([Rough Surfaces]) &lt;--&gt; B([Atoms in zig-zag pattern])     B &lt;--&gt; C([Atoms fitting real tight])     B &lt;--&gt; D([More Friction])         </pre>
G21	E11, E12	E13

Legends: Same as Table 5.1.

**Table 5-3: Variations in the associations made by students in Activity #3 (Graphing of Friction Force vs. Roughness)**

<b>Graphing of Friction Force vs. Roughness of Surfaces</b>			
<i>Association #1</i>	<i>Association #2</i>	<i>Association #3</i>	<i>Association #4</i>
<p>Graph of Friction Force vs. Surface Roughness</p> 	<p>Graph of Friction Force vs. Surface Roughness</p> 	<p>Graph of Friction Force vs. Surface Roughness</p> 	<p>Graph of Friction Force vs. Surface Roughness</p> 
PW1, E24	G11,G12,G13,G14,G21,G22, E11,E13,E14E21,E22,E24, G24	E12	E23

*Legends:* PW – Physical World G1- General Physics 1 G2- General Physics 2

E1 - Engineering Physics 1 E2 – Engineering **Physics** G11- General Physics 1 Student #1...etc.

**Table 5-4: Variations in the associations made by students in Activity #4 (Metal Blocks Activity)**

<b>Metal Blocks Activity (Prediction)</b>		
<i>Association #1</i>	<i>Association #2</i>	<i>Association #3</i>
E11	E12	E13, E24, E22
<i>Association #4</i>	<i>Association #5</i>	<i>Association #6</i>
E23	E21	PW1, PW2, G11, G12, G13, G14, G21, G22, G23, E14, G24

*Legends:* PW – Physical World G1- General Physics 1 G2- General Physics 2

E1 - Engineering Physics 1 E2 – Engineering Physics G11- General Physics 1 Student #1...etc.

**Table 5-5: Variations in the associations made by students in Activity #4 (Metal Blocks Activity)**

<b>Metal Blocks Activity (Explanation)</b>			
<i>Association #1</i>	<i>Association #2</i>	<i>Association #3</i>	<i>Association #4</i>
PW1, PW2, G12, G22, G23, E22	G11, G13	G13, G14, E13	G13, E21
<i>Association #5</i>	<i>Association #6</i>	<i>Association #7</i>	<i>Association #8</i>
G21, E12	E11, E13, E21, G24	E14	E21

*Legends:* Same as Table 5-4

**Table 5-6: Variations in the associations made by students in Activity #6 (Papers & Transparency Activity)**

<b>Papers &amp; Transparency Activity (Prediction)</b>			
<i>Association #1</i>	<i>Association #2</i>	<i>Association #3</i>	<i>Association #4</i>
<pre> graph TD     A([Flat Paper on the Transparency]) &lt;--&gt; B([Static])     B &lt;--&gt; C([Sticking])     C &lt;--&gt; D([More Friction])             </pre>	<pre> graph TD     A([Flat Paper on the Transparency]) &lt;--&gt; B([Both Flat])     B &lt;--&gt; C([Connect More])     C &lt;--&gt; D([Harder to Pull])             </pre>	<pre> graph TD     A([Crumpled Paper Transparency]) &lt;--&gt; B([Less Contact])     B &lt;--&gt; C([Less Force])             </pre>	<pre> graph TD     A([Crumpled Paper]) &lt;--&gt; B([Rough])     B &lt;--&gt; C([More Friction])             </pre>
PW1, PW2, G12, G21, E13, E21	G11	G14	G22
<i>Association #5</i>	<i>Association #6</i>		<i>Association #7</i>
<pre> graph TD     A([Crumpled Paper on the Transparency]) &lt;--&gt; B([More Area Touching])     B &lt;--&gt; C([More Friction])             </pre>	<pre> graph TD     A([Crumpled Paper on the Transparency]) &lt;--&gt; C([Same Friction])     B([Flat Paper on the Transparency]) &lt;--&gt; C             </pre>		<pre> graph TD     A([Flat Paper on the Transparency]) &lt;--&gt; B([Smooth on Smooth Metal Surfaces])     B &lt;--&gt; C([More Friction])             </pre>
E12, E13, E14, E23, E24, G24	E14, E22		E11

*Legends:* Same as Table 5-4



**Table 5-7: Variations in the associations made by students in Activity #6 (Papers & Transparency Activity)**

<b>Papers &amp; Transparency Activity (Explanation)</b>		
<i>Association #1</i>	<i>Association #2</i>	<i>Association #3</i>
PW1,G11,G12,G21,G22,E11, E12,E14,E21, E23, E24	PW2	PW2
<i>Association #4</i>	<i>Association #5</i>	<i>Association #6</i>
G14	G22, G23	E13,E22

*Legends:* Same as Table 5-4

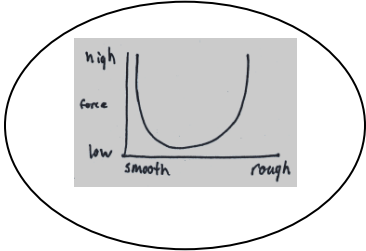
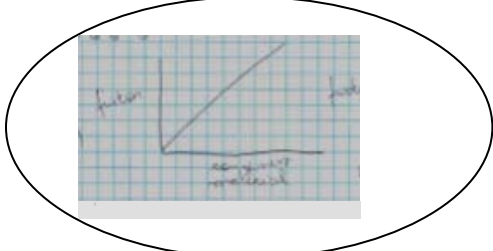
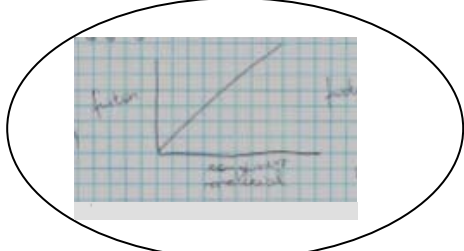
**Table 5-8: Variations in the associations made by students after Activity #6 (Papers & Transparency) & Activity 7 (Sketching)**

<b>Metal Blocks Observation (Explanation 2)</b>		
<i>Association #1</i>	<i>Association #2</i>	<i>Association #3</i>
<pre> graph TD     A([Smooth on Rough Metal Sides]) &lt;--&gt; B([Less Contact])     B &lt;--&gt; C([Easier to Slide])             </pre>	<pre> graph TD     A([Smooth on Smooth Metal Sides]) &lt;--&gt; B([More Atoms Touching])     B &lt;--&gt; C([More Attraction])             </pre>	<pre> graph TD     A([Smooth on Smooth Metal Sides]) &lt;--&gt; B([More Surface Area Touching])     B &lt;--&gt; C([More Friction])             </pre>
PW1, G11, E12	PW2, E21, E24, G24	G12, G22, E22, E24
<i>Association #4</i>	<i>Association #5</i>	<i>Association #6</i>
<pre> graph TD     A([Smooth on Smooth Metal Sides]) &lt;--&gt; B([More Attracted])     B &lt;--&gt; C([More Friction])             </pre>	<pre> graph TD     A([Smooth on Smooth Metal Sides]) &lt;--&gt; B([More Charge])     B &lt;--&gt; C([Greater Resisting Force])             </pre>	<pre> graph TD     A([Smooth on Smooth Metal Sides]) &lt;--&gt; B([More Molecules Making Contact])     B &lt;--&gt; C([More Friction])             </pre>
G14, E11	G22, G23	E23

Legends: Same as Table 5-4



**Table 5-9: Variations in the associations made by students in Activity # 9 Revisiting & Modifying Graph of Friction Force vs. Roughness)**

Modified Graph of Friction Force vs. Roughness of Surfaces		
Association #1	Association #2	Association #3
<p>Graph of Friction Force vs. Surface Roughness</p> 	<p>Graph of Friction Force vs. Increasing Roughness (Not Charged)</p> 	<p>Graph of Friction Force vs. Increasing Smoothness (Charged)</p> 
<p>PW1, PW2, G11, G12, G13, G14, G21, G22, E11, E12, E13, E14, E21, E22, E23, E24, G24</p>	<p>G23</p>	<p>G23</p>

Legends: Same as Table 5-4

**Table 5-10: Associations made by students in Activity # 10 (Dragging of Wooden Block on its Wide and Narrow Sides)**

PREDICTIONS		
Association #1	Association #2	
G11, G12, G14, G24, G21, G22, G23, E11, E12,	E13	
Association #3	Association #4	Association #5
E21	E22,	E23

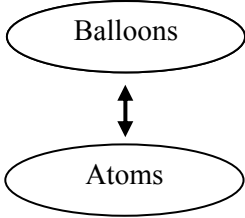
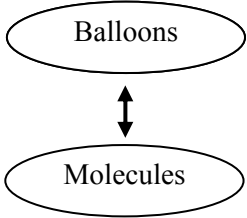
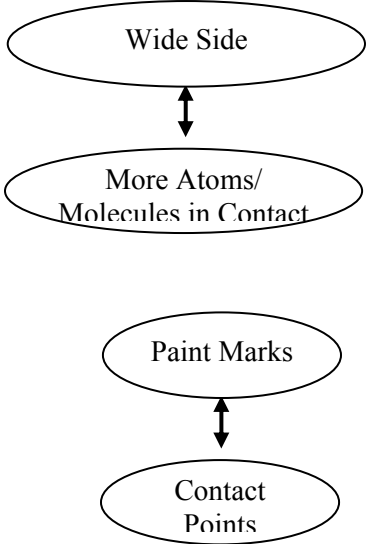
Legends: Same as Table 5-4

**Table 5-11: Associations made by students in Activity # 10 (Dragging of Wooden Block on its Wide and Narrow Sides)**

EXPLANATIONS		
Association #1	Association #2	Association #4
G11, G14, G22, E22	G12, E12	E11
G24, G23, E21	G21	E13

Legends: Same as Table 5-4

**Table 5-12: Associations made by students in Activity # 11 (Balloon Activity)**

<i>Association #1</i>	<i>Association #2</i>	<i>Association #3</i>
		
G11, G14, G24, G21, G22, G23, E11, E21, E22, E23	G12, E12	G11, G12, G14, G24, G21, G22, E11, E12, E21, E22, E23, G23

*Legends:* Same as Table 5-4

**Table 5-13: Associations made by students in Relating the Balloon Activity with the Wooden Block Activity**

Association #1	Association #2	Association #3
<pre> graph TD     WS1([Wide Side]) --&gt; SCA1([Same Contact Area])     NS1([Narrow Side]) --&gt; SCA1     SCA1 &lt;--&gt; SFF1([Same Friction Force])         </pre>	<pre> graph TD     WS2([Wide Side]) --&gt; MAC2([More Atoms in Contact])     WS2 --&gt; LCA2([Less Contact/Atom])     NS2([Narrow Side]) --&gt; LA2([Less Atoms in Contact])     NS2 --&gt; MCA2([More Contact/Atom])     WS3([Wide Side]) --&gt; SCA2([Same Contact Area])     NS3([Narrow Side]) --&gt; SCA2     SCA2 &lt;--&gt; SFF2([Same Friction Force])         </pre>	<pre> graph TD     WS3([Wide Side]) --&gt; SP3([Same Pressure])     NS3([Narrow Side]) --&gt; SP3     SP3 &lt;--&gt; SSA3([Same Surface Area in Contact])     SSA3 &lt;--&gt; SFF3([Same Friction Force])         </pre>
G11, G12, G14, G23	G24, G21, G22, E11, E12, E21, E22,	E23

**Table 5-14: Associations made by students as they go through the mathematical modeling activity.**

Association #1	Association #2	Association #3
<p>Friction ↔ <math>\mu N</math></p> <p>Friction ↔ <math>cA</math></p> <p>Friction ↔ <math>cA + F_N\mu</math></p>	<p>Friction ↔ <math>\mu N</math></p> <p>Friction ↔ <math>cA</math></p> <p>Friction ↔ <math>\mu(N + Ac)</math></p>	<p>Friction ↔ <math>\mu N</math></p> <p>Friction ↔ <math>cA</math></p> <p>Friction ↔ <math>cA \frac{1}{roughness} + \mu N</math></p>
G24, G23, E21, E22, E23, E24	E12	E14



### ***5.5.2 Individual Teaching Interview - The Case of George<sup>1</sup>***

In this section the case of one of the students is presented in order to provide details on how a typical student dynamically constructed his ideas during the teaching interview. George – a Mechanical Engineering major in a second semester calculus-based class had previously taken high school physics and first semester of engineering physics.

Table 5-15 shows transcript segments during the metal blocks activity and the corresponding associations that George progressively made. At this point he had already developed the idea that friction varies linearly with roughness (based on the first three activities) and it approaches zero when two surfaces become extremely smooth. When asked to predict in which case (smooth on rough vs. smooth on smooth) friction will be greater in the metal block activity, George predicted that it would be greater in the smooth on rough case. As expected, he constructed similarities between the situations at hand and his previous experiences with rough surfaces, transferring to this situation what he had learned earlier about how rough surfaces behave.

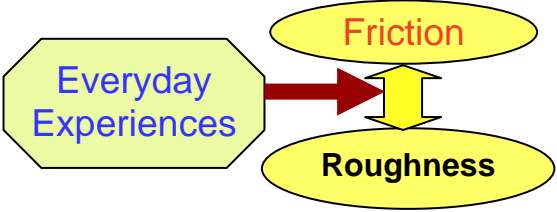
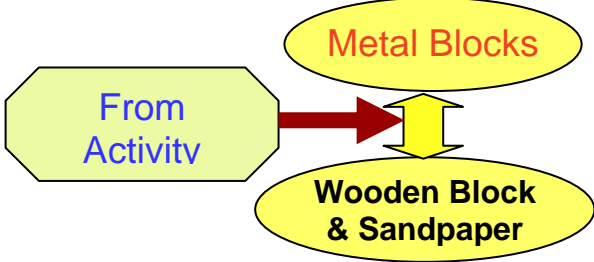
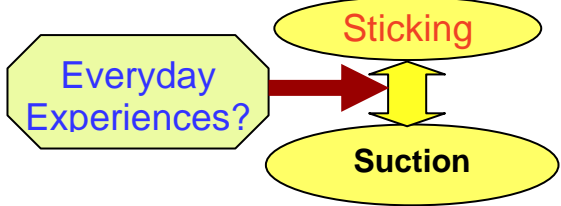
When asked to explain his observation that it actually took more force to slide the two smooth sides together (because the two surfaces actually stuck together), he tried to make sense of the situation by activating his personal experience about sticking and came up with the association between sticking and suction. However, he expressed a lack of confidence in this explanation based on suction.

After the metal block activity, I presented George with the paper and transparency activity. Table 5-16 shows the attributes of the situation i.e. the ‘target tools’ George read out while making his prediction, the associations he constructed and the factors that controlled the activations of these associations. He first predicted that there would be more friction between the uncrumpled sheet of paper and transparency because they would have more contact. In further making sense of the situation he activated his prior knowledge about how surface area came into play in friction as he learned in previous physics classes. He then appears to have suppressed the associations he made earlier between contact area and friction.

---

<sup>1</sup> Real names are not used in this dissertation.

**Table 5-15: Knowledge construction during the metal block activity**

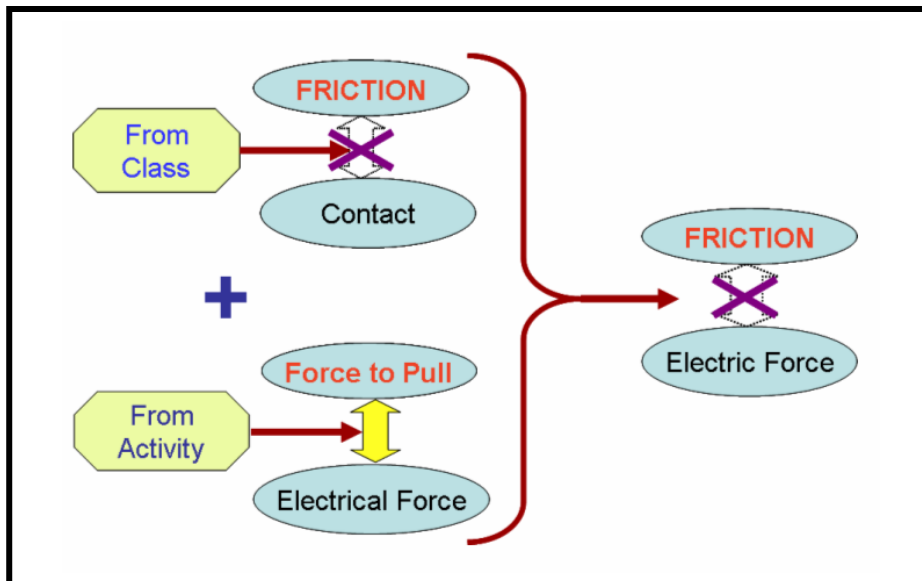
Transcript	Associations
<p>Uhhm, I would assume greater friction...like between this (smooth side) and that (rough side) surface? The top (smooth) and the (rough) sides will probably have more friction because they are not quite smooth. The top will be less because they are both quite smooth.</p>	 <p>The diagram consists of a light green octagonal box on the left containing the text 'Everyday Experiences'. A red arrow points from this box to a yellow double-headed vertical arrow. To the right of this vertical arrow are two yellow ovals: the top one contains the word 'Friction' and the bottom one contains the word 'Roughness'.</p>
<p>Because the sides didn't feel quite as smooth as the top. The top is really, really smooth. &lt;So where are you basing your prediction?&gt; Basically, just the roughness and smoothness of the sides. The more roughness there is, it seems like there'll be more friction...Basically it's the same reason as these surfaces here (points to the wooden plank and sandpaper).</p>	 <p>The diagram consists of a light green octagonal box on the left containing the text 'From Activity'. A red arrow points from this box to a yellow double-headed vertical arrow. To the right of this vertical arrow are two yellow ovals: the top one contains the text 'Metal Blocks' and the bottom one contains the text 'Wooden Block &amp; Sandpaper'.</p>
<p>&lt;Was that what you expected?&gt;          Nope. Not at all. I assume, it sticks on the top, kind of, especially the harder I press down. If I press down really hard, I can barely move it at all. Then the sides, the sides, the harder I press, it doesn't really seem to make too much a difference. I don't know why it would do that...it's weird...it sticks for some reason but.... uhhh maybe...it could have...I don't know...almost feels like some kind of suction between the two surfaces. But I don't know if that's the case or not.</p>	 <p>The diagram consists of a light green octagonal box on the left containing the text 'Everyday Experiences?'. A red arrow points from this box to a yellow double-headed vertical arrow. To the right of this vertical arrow are two yellow ovals: the top one contains the word 'Sticking' and the bottom one contains the word 'Suction'.</p>

**Table 5-16: Knowledge construction during the papers & transparency activity**

Transcript	Associations
<p><b>Prediction:</b>            Greater friction would probably be that one (uncrumpled paper) because it's gonna have more contact with the surface because it's flat. That one (crumpled) is touching the table at some point, but that one is flatter so it will probably have more friction. But the coefficient of friction will probably, wouldn't change, but... actually wait... uhhm (pause) I guess...I don't know...I guess they would be the same because I guess friction doesn't really matter on the surface area touching the surface. Friction basically depends on the normal force and the coefficient of friction. &lt;Did you learn that somewhere?&gt; Yeah...EP1 pretty much. Just thought that it doesn't really matter on the size of the contact. It just depends on how much force pushing down on it and the coefficient of friction between the two surfaces. The friction force is <math>\mu</math> times normal force.</p>	<p>The top diagram shows 'From Activity' pointing to 'Friction' and 'Contact Area' connected by a double-headed arrow. The middle diagram shows 'From Class' pointing to a crossed-out 'Friction' and 'Contact Area' connected by a double-headed arrow. The bottom diagram shows 'From Class' pointing to 'Friction' and '<math>\mu N</math>' connected by a double-headed arrow.</p>
<p><b>Observation-Explanation</b>            This one (uncrumpled paper) is a lot harder to pull but it's probably because of some electrostatic repul.. attraction between the plastic and the paper. So I guess that's really not friction.            ....there was really less points of contact. So...it's not as attracted as that one (crumpled) because in that one the entire surface is resting on top of the plastic. In here (crumpled paper) it has very few points of contact and so it's not attracted as much as that one (uncrumpled).</p>	<p>The top diagram shows 'From Activity' pointing to 'Force to Pull' and 'Electrical Interaction' connected by a double-headed arrow. A line from 'From Class' points to a crossed-out 'Force to Pull' and 'Friction' connected by a double-headed arrow. The bottom diagram shows 'From Activity' pointing to 'Force to Pull' and 'Contact Points' connected by a double-headed arrow.</p>

As per diSessa's coordination class theory, DiSessa and Wagner 2005 George displaced the association that "more contact area means more friction" and instead recruited the association from class that "contact area does not affect friction" and " $\mu N$  is friction" into his prediction because this is what he learned in class. These associations, I believe, were subsequently incorporated into his internal knowledge and later used as 'source tools' to make further associations.

In explaining his observation in the paper-transparency activity that more force is needed to slide the uncrumpled paper across the sheet of transparency, George seemed to use the newly activated source tools ("contact area does not affect friction" and " $\mu N$  is friction") and the association that "electrical interaction affects the force to pull" to construct a new association (Figure 5.18) that "friction is not electrical force." At this point the interviewer provided the input that electrical interaction could indeed be friction, effectively expanding, what diSessa would call, George's 'span' of the coordination class of friction.



**Figure 5.18: Construction of new associations based on previous associations (Paper-transparency explanation)**

Later in the interview, George was directed to go back to his original graph of friction vs. roughness, and asked whether at all he needed to modify the graph. We can see (Table 5-17) how he recruited and displaced earlier associations to construct a new association between

increasing friction and increasing roughness and also between increasing friction and increasing smoothness. I believe that in constructing these associations, George had to displace his association that “contact area does not affect friction” and incorporate the association that more contact “area means more friction” and “electrical interaction is friction.”

George’s final model which as expressed through his modified graph and verbal explanation and represented using the resource graph shown in Table 5-17 can also be described as a conceptual blend between his previous model and new experiences.

Based on the above data I concluded that in expanding the span by providing inputs of mental resources to scaffold learning, the control of associations (incorporation and displacement) can be made more efficient. In George’s case, the scaffolding activities appeared to facilitate efficient control of displacement and incorporation of associations to explain his observations and construct a new model of microscopic friction.

**Table 5-17: Modifying the graph of friction vs. roughness of the sliding surfaces**

Transcript	Associations
<p>I guess smoother and smoother, smoother and smoother more friction would be till.. So it will go up high somewhere and then the rougher it got, the less friction would be. Then, I guess something like that. But, I guess when we have really, really rough, the friction force will start going up again. So something like that. ...Well, with the smoother it is like here (smooth side of the metal block) there's a lot more friction and as it gets a little bit rougher like between the (rough side of metal block) there'll be less friction. But once you get really, really rough like the sandpaper, it will probably start to go up again, so there'll be more friction. But if it's really smooth, there can be a lot of friction to it.</p>	<p>The diagram illustrates the relationship between friction and surface roughness through two activities. The 'Wooden Block-Sandpaper Activity' shows that as roughness increases, friction also increases. The 'Metal Blocks &amp; Paper-Transparency Activity' shows that as smoothness increases (which is equivalent to decreasing roughness), friction also increases. A purple bracket groups these two associations and points to a hand-drawn graph on grid paper. The graph plots Friction on the vertical axis and Roughness on the horizontal axis. The curve starts high on the left (smooth surface), decreases to a minimum in the middle (intermediate roughness), and then increases again on the right (very rough surface), forming a U-shape.</p>

### ***5.5.3 Individual Teaching Interview- The Case of Steve & Rose***

In order to document how the Zone of Proximal Development (ZPD) impacts the model construction or reconstruction of students, two students (Steve & Rose) were purposely chosen from the pool of interviewees. Steve was taking a first semester algebra-based physics and had no prior instruction in electrostatics while Rose was taking a second semester calculus-based physics and had prior instruction in electrostatics.

Table 5-18, Table 5-19:, and Table 5-20 present the detailed results of knowledge construction by Rose and Steve. In Table 5-18 we can see that both students seemed to provide the same explanations about friction: It was harder to pull the wooden block across the sandpaper because the surfaces are rougher. If the surfaces are made smoother and smoother the friction will decrease and eventually approach zero as depicted by the graphs in Table 5-18.

As can be seen in Table 5-19:, the gauge block activity put the two students in a state of cognitive dissonance in that their observations contradicted their predictions. At this point of the teaching interview the students realized that their current model is not enough to explain their observations. Although Rose right away realized that there are other forces that affect friction she can't actually tell what is causing the difference. To resolve the conflict I have them do the paper and transparency activity (Table 5-20). This scaffolding activity helped the two students construct the idea that friction is dependent on the actual contact between two surfaces.

Moreover, the gauge block activity led Rose to the idea that friction at the atomic level is due to electrical interactions (bonding of atoms). In the case of Steve this scaffolding provided him a hint that his present model is not enough so there is a need for him to reconstruct it. The metal blocks and papers & transparency activities helped him construct the idea that friction is dependent on the actual contact between two surfaces. However, it did not facilitate his thinking of electrical interactions as the cause of friction.

In Table 5-21 we can see how the two students reconstructed their ideas about how friction varies with surface roughness and the factors that come into play when surfaces become extremely smooth. The different scaffolding activities successfully led them to construct a model consistent with the target model that friction force varies with the relative roughness of the surfaces as depicted in the figure shown in Table 5-21.

With respect to the target ideas of the variation of friction with surface roughness and the role of contact area, it is apparent that the two students are at the same Zone of Proximal Development (ZPD). However, with respect to the target idea that friction is due to electrical interactions and the mathematical model in equation (1) the students are in different ZPDs.

For Rose, the scaffolding provided was productive in facilitating construction of a model given by

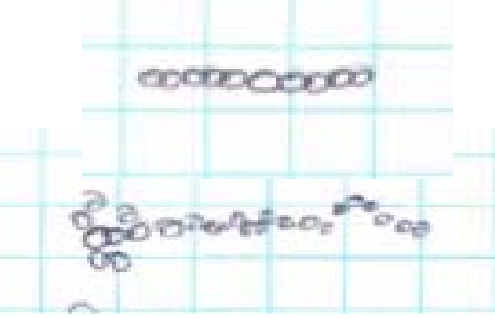
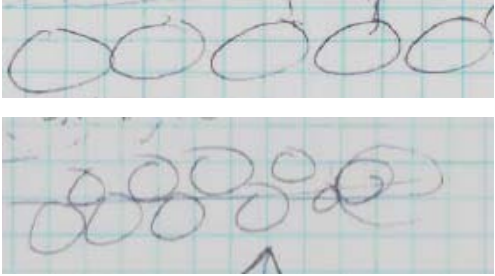
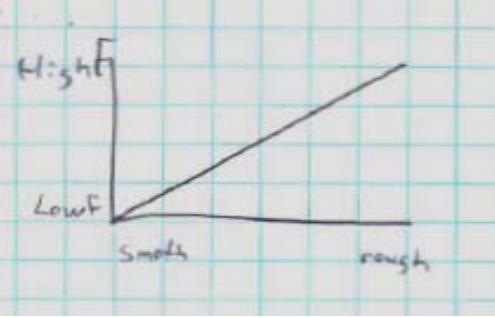
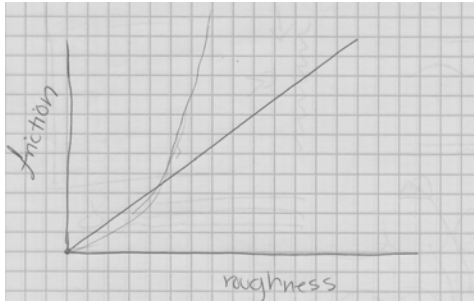
$$f = \mu N + cA \quad \text{Equation 5.3}$$

This is probably because she already had learned the equation  $f = \mu N$  prior to the interview and was also familiar with electrical interactions.

The activities with the gauge blocks and transparency helped her build on her previous model ( $f = \mu N$ ) to arrive at the model  $f = \mu N + cA$ . Steve was not familiar with the friction model given by  $f = \mu N$ . He was also not familiar with electrostatic interactions before completing this activity. Although the activities helped him construct a model that was qualitatively accurate, he was unable to express this model in terms of equation 5.3 or understand the electrical origins of friction.



**Table 5-18: Scaffolding inputs and ideas generated by Steve and Rose**

<b>ACTIVITY 1: FEELING &amp; SKETCHING OF SURFACES</b>	
<b>Sample Questions/Instructions:</b> Please sketch what the surfaces would look like at the level where you see the atoms.	
<b>Steve's Ideas</b>	<b>Rose's Ideas</b>
Smooth surface is represented by atoms lining up while rough surface is represented by atoms arranged in up and down	Smooth surface is represented by atoms lining up while rough surface is represented by atoms arranged in up and down pattern.
	
<b>ACTIVITY 2: WOODEN BLOCK DRAGGED ACROSS THE WOODEN PLANK AND SANDPAPER SURFACE</b>	
<b>Questions:</b>	
<ul style="list-style-type: none"> <li>• Could you please explain what you observed?</li> <li>• Why is the force greater on the sandpaper than on the wooden plank?</li> </ul>	
<b>Steve's Ideas</b>	<b>Rose's Ideas</b>
<i>"More Newtons of force to pull it on the sandpaper than on here (wooden plank) because it is rougher. It was harder to pull across because the bumps will catch with each other."</i>	<i>"It was easier to drag the wooden block across the wooden surface than on the sandpaper because the sandpaper is a lot rougher and it has like bigger ridges"</i>
<b>ACTIVITY 3: GRAPHING OF FRICTION VS SURFACE ROUGHNESS</b>	
<b>Questions:</b>	
<ul style="list-style-type: none"> <li>• Please sketch how the friction force varies with the roughness of both surfaces.</li> <li>• Explain the details of your graph.</li> </ul>	
<b>Steve's Ideas</b>	<b>Rose's Ideas</b>
<i>"The rougher the surface the higher the friction becomes. The smoother it is the smaller the friction".</i>	<i>"Pretty linear relationship. As the roughness increases so does the friction. And I suppose that it could be like not linear, but in any case as one increases the other also increases."</i>
	

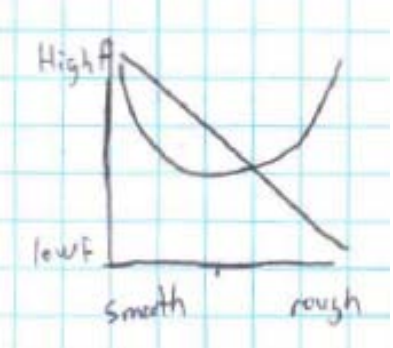
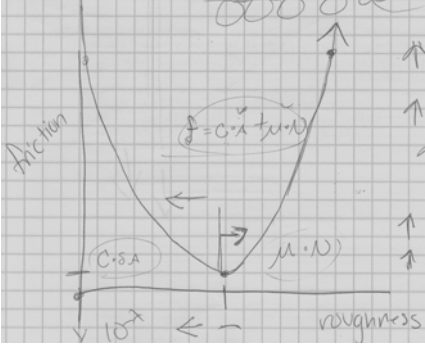
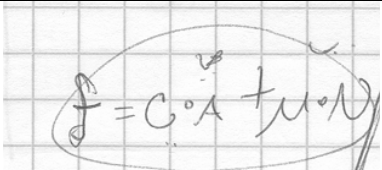
**Table 5-19: Scaffolding inputs and ideas generated by Steve and Rose (continued)**

<p><b>ACTIVITY 4: METAL BLOCKS ACTIVITY</b>  <b>Questions/Instructions:</b></p> <ul style="list-style-type: none"> <li>• Please slide fingernails across the surfaces of the metal blocks.</li> <li>• Sketch how the surfaces would look like at the level where you see the atoms.</li> <li>• In which case (smooth vs. smooth or smooth vs. rough) will you have more friction?</li> </ul>	
<b>Steve's Ideas</b>	<b>Rose's Ideas</b>
<p><i>"More friction on this one (rough side of metal block) because it is rougher."</i></p>	<p><i>"You'll gonna have more friction with the rough surface than on the smooth surface because the rough surface would resist the movement more because you have like bigger places to catch on so it will gonna get stuck more easily."</i></p>
<p><b>ACTIVITY 4: METAL BLOCKS ACTIVITY</b>  <b>Questions/Instructions:</b></p> <ul style="list-style-type: none"> <li>• Slide the smooth surfaces together then the smooth on the rough surface</li> <li>• Explain your observation.</li> </ul>	
<b>Steve's Ideas</b>	<b>Rose's Ideas</b>
<p><i>"It feels like there's less friction on the surface that feels rougher. "I don't know. I don't have any idea why."</i></p>	<p><i>"There are other forces that would affect friction. You might have cohesion because the materials kind of stick together...You have some type of atomic forces that make them stick together."</i></p>

**Table 5-20: Scaffolding inputs and ideas generated by Steve and Rose (continued)**

<b>ACTIVITY 5: PAPERS ON TRANSPARENCY ACTIVITY</b>	
<b>Questions/Instructions:</b> Predict in which case will you have more friction when the flat sheet and crumpled piece of papers are slid across the transparency	
<b>Steve's Ideas</b>	<b>Rose's Ideas</b>
<i>"Probably this (flat sheet) because like electrostatic charges will cling to it more, I think than it would on this one (crumpled)."</i>	<i>"On the scale that we are considering this one would have more friction because it has more area touching each other. For the crumpled paper if you lay it down there's not much surface area in contact with the other surface. "</i>
<b>ACTIVITY 5: PAPERS ON TRANSPARENCY ACTIVITY</b>	
<b>Questions:</b>	
<ul style="list-style-type: none"> <li>• Slide the crumpled and flat sheet of paper across the transparency.</li> <li>• What did you observe?</li> <li>• Was that what you predicted?.</li> </ul>	
<b>Steve's Ideas</b>	<b>Rose's Ideas</b>
<i>"There's more on this one because there's more touching. In this one because it is crumpled up it's not lying flat on it. I'd say the greater the surface area the more friction it would have."</i>	<i>"That one has more friction because there's more surface area touching. "</i>
<b>ACTIVITY 6 : SLIDING OF PAPERS ACROSS THE TRANSPARENCY RUBBED WITH FUR</b>	
<b>Question/s:</b> What is causing the friction between the two surfaces?	
<b>Steve's Ideas</b>	<b>Rose's Ideas</b>
<i>"It's static electricity or something. When you rub this it kind of create a static charge and it will gonna cling to it (paper)."</i>	Not Necessary
<b>ACTIVITY 6: RELATING THE METAL BLOCKS AND PAPERS ON TRANSPARENCY ACTIVITIES</b>	
<b>Question/s:</b> How would you relate the one you did on the metal blocks and the one with the papers on transparency?	
<b>Steve's Ideas</b>	<b>Rose's Ideas</b>
<i>"There's more friction on the flat sheet because they more surface area touching and that would be the same for that one too (smooth metal block surface). There's more surface area touching on this one (smooth side of the metal block) than on this side here (rough side of the metal block)"</i>	<i>"With these two (smooth sides of metal block) you have more surface area touching each other and so more surface area means more contact between the little bumps or little microscopic atoms or whatever. And so more chances for them to interact."</i>

**Table 5-21: Scaffolding inputs and ideas generated by Steve and Rose (continued)**

<b>ACTIVITY 7: REVISITING THE GRAPH OF FRICTION FORCE VS ROUGHNESS</b>	
<b>Question/s:</b> <ul style="list-style-type: none"> <li>• Do you still go with the graph that you have drawn earlier?</li> <li>• If you are to modify your graph what would it look like?</li> <li>• What happens when surfaces become very very smooth?</li> <li>• What happens when they are very rough like the sandpaper?</li> </ul>	
<b>Steve's Ideas</b>	<b>Rose's Ideas</b>
<p>"The smoother the object is, just like what we had there (points to metal blocks), the smoother the greater the friction... when it gets rougher like that (points to sandpaper) the friction would be high too".</p> 	<p>" If you have high roughness you will still have high friction... when you have perfect smoothness, they would gonna bond back together and you will have infinite friction. So you will have a nice little parabola".</p> 
<b>ACTIVITY 8: MATHEMATICAL MODELING</b>	
<b>Question/s:</b> <ul style="list-style-type: none"> <li>• How would you compute the friction force between the wooden block and the sandpaper surface?</li> <li>• If we go back to your sketch of the flat sheet of paper and transparency what would be the factors that we need to consider?</li> <li>• Let us zero in on your sketch for the smooth metal blocks. If we represent c as the force needed to overcome the interaction between pairs of atoms, how would you calculate the total force needed to move one surface over the other?</li> <li>• In which part of your graph does <math>\mu N</math> dominate and which part of your graph does 'cA' dominate?</li> <li>• What factors come into play in the lowest portion of your graph?</li> </ul>	
<b>Steve's Ideas</b>	<b>Rose's Ideas</b>
<p>Not Completed</p>	

#### ***5.5.4. Group Teaching Interviews***

In this section the results of the investigation of students' knowledge construction in the context of group teaching interviews are presented. I will attempt to discuss how students used different inputs (from the interviewer, other members of the group) in the construction and reconstruction of their ideas as they worked in groups.

In addressing the aforementioned issues, the cases of four different groups of students are presented below. These groups were purposefully selected in order to document the observed variations in which students interacted with each other and how they built their ideas off each other. The associations that students in the group teaching interview generated will likewise be presented.

##### ***5.5.4.1 Group Teaching Interview- The Case of Lynn, Jeff & Meg***

Lynn is a major in Chemical Engineering while both Jeff and Meg are majoring in Mechanical Engineering. They were currently enrolled in a second semester calculus-based physics course during the time of the interview.

It can be seen in Table 5-22. Associations made by students in the Feeling & Sketching of Surfaces that Lynn, Jeff & Meg had similar associations with rough and smooth surfaces. Rough surface is associated with up and down arrangement of atoms while smooth surface is associated with atoms lining up. These associations are consistent with results from the individual teaching interviews. Students interviewed had the previously observed conceptual trajectory with respect to smooth and rough surfaces at the atomic level. That is, smooth surfaces are represented with atoms lining up and rough surfaces are represented with an up-and-down arrangement of atoms. These ideas were further brought out when students were asked to sketch the case of the wooden block dragged across the wooden plank and the case where the wooden block is dragged across the sandpaper surface (see Table 5-23).

When students were asked to sketch a graph of the friction force versus the surface roughness, Lynn and Jeff drew a linear type of graph while Meg drew a graph that curved down. (See Table 5-24) According to Meg

“I did a curve line because as I said earlier it seems like there can be a limit to the extent we can make something like sandpaper coarser and coarser”

Later, Jeff agreed that the curved graph makes sense in that friction would tend to “flatten out at a certain boundary”. This made him modify the linear graph to a curved one.

Table 5-25 shows the associations made by the students during the metal blocks activity. It can be seen that two of the students (Lynn and Jeff) predicted that it will be harder to slide the smooth metal block side across the rough metal block side. Meanwhile Meg predicted that it would be the smooth on smooth the reason being that she learned that materials can become so smooth that the surfaces can be close together and would likely to bond with each other. Jeff appears to have based his predictions on what he observed with the wooden blocks.

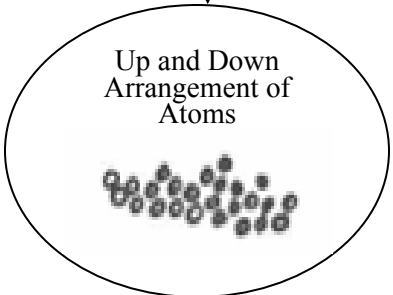
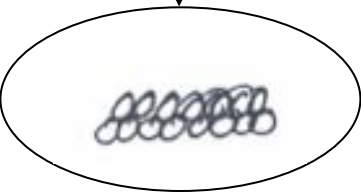
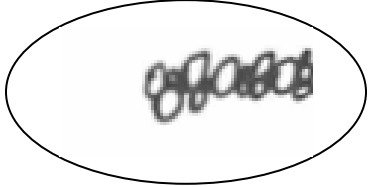
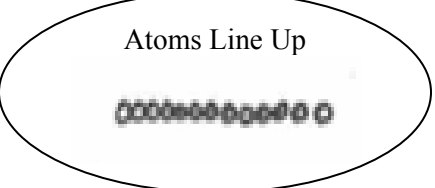
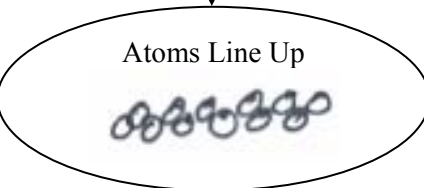
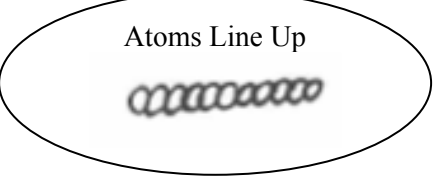
“Just like in the sandpaper, it is easier to slide it across the smoother surface. So I figured it would be the same thing with these (metal blocks)”.

In explaining their observation that it was actually harder to slide the smooth metal block side on the smooth side, Lynn used the ‘bonding’ model. It is likely that her ideas about bonding have been activated partly by Meg’s prediction that the surfaces may actually bond with each other. Meanwhile, according to Jeff it was harder to pull on the smooth-on-smooth side of the metal blocks because there is more surface area interacting. The activity of having students sketch the sliding surfaces at the level where they see the atoms was likely to have influenced them to make the associations as depicted in Table 5-25. For this particular group the activity with the papers and transparency were not necessary to activate their ideas about charges.

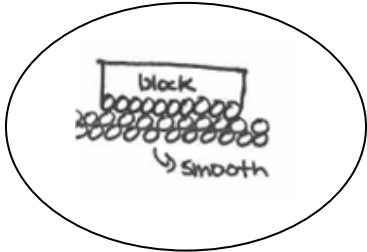
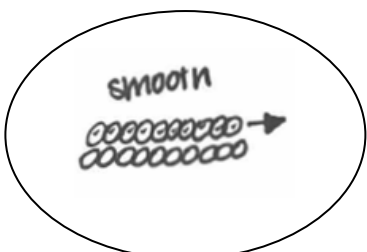
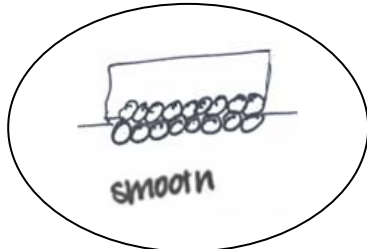
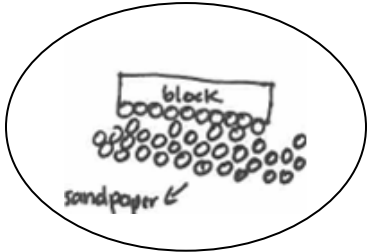
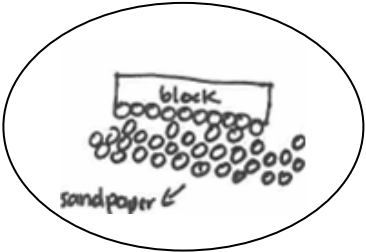
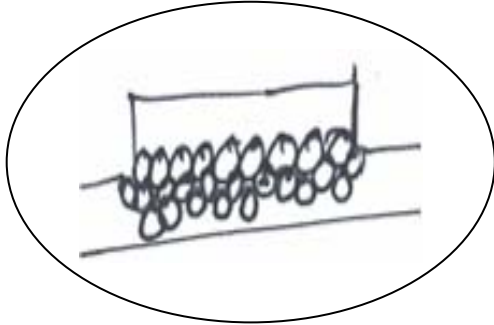
Table 5-26 shows the modified versions of their graph of friction force versus roughness after going through the scaffolding activities. We can clearly see that the three students ended up with the same associations as in the individual group interviews -- increasing roughness means increasing friction and increasing smoothness means increasing friction as well.

It can be seen in Table 5-27 that the paper and transparency activity made the students to associate differences in the force with the amount of contact area. When students were asked to explain their observations with the metal block (Table 5-28) after doing the papers and transparency activity, these students associated the difference in the force with the bonding of the atoms as well as the amount of surface touching.

**Table 5-22. Associations made by students in the Feeling & Sketching of Surfaces**

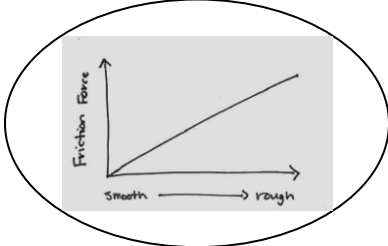
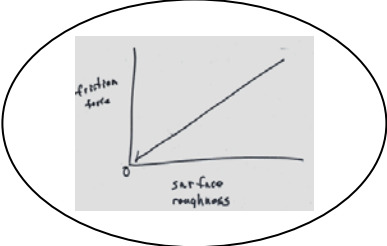



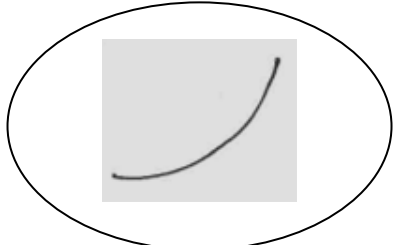
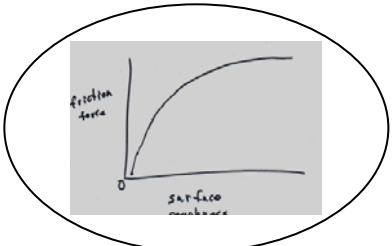

<b>Rough Surfaces</b>		
<i>Lynn</i>	<i>Jeff</i>	<i>Meg</i>
<p>Rough Surface</p> <p>↕</p> <p>Up and Down Arrangement of Atoms</p> 	<p>Rough Surface</p> <p>↕</p> 	<p>Rough Surface</p> <p>↕</p> 
<b>Smooth Surfaces</b>		
<i>Lynn</i>	<i>Jeff</i>	<i>Meg</i>
<p>Smooth Surface</p> <p>↕</p> <p>Atoms Line Up</p> 	<p>Smooth Surface</p> <p>↕</p> <p>Atoms Line Up</p> 	<p>Smooth Surface</p> <p>↕</p> <p>Atoms Line Up</p> 

**Table 5-23: Associations made by students in the “Feeling & Sketching of Surfaces”**

<b>Rough Surfaces</b>		
<i>Lynn</i>	<i>Jeff</i>	<i>Meg</i>
<p>Smooth on Smooth (Wood Block on Plank)</p> 	<p>Smooth on Smooth (Wood Block on Plank)</p> 	<p>Smooth on Smooth (Wood Block on Plank)</p> 
<p>Smooth on Rough (Wood Block on Sandpaper)</p> 	<p>Smooth on Rough (Wood Block on Sandpaper)</p> 	<p>Smooth on Rough (Wood Block on Sandpaper)</p> 




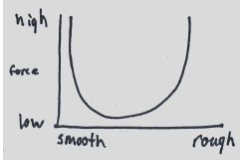

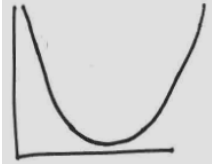
**Table 5-24: Associations made by students in the Graph of Friction vs. Roughness of Surfaces**

Graphing of Friction Force vs. Surface Roughness		
Lynn	Jeff	Meg
<p>Graph of Friction Force vs. Roughness of Surfaces</p> 	<p>Graph of Friction Force vs. Roughness of Surfaces</p> 	<p>Graph of Friction Force vs. Roughness of Surfaces</p>
		
<p>Graph of Friction Force vs. Roughness of Surfaces</p> 	<p>Graph of Friction Force vs. Roughness of Surfaces</p> 	

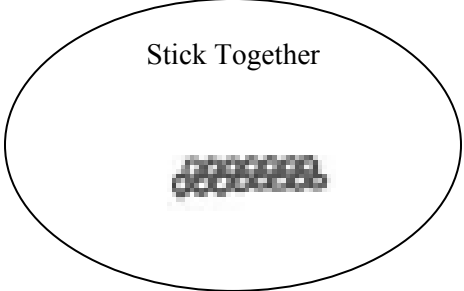
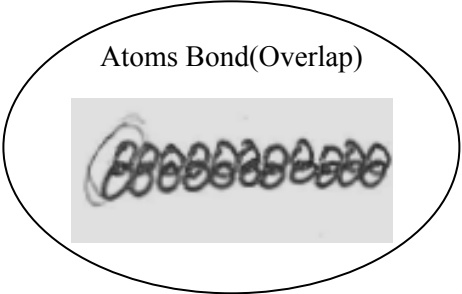
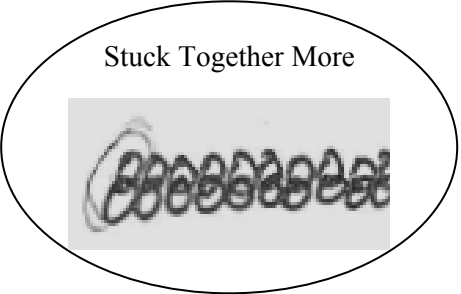
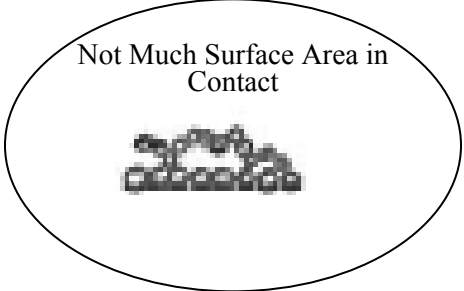
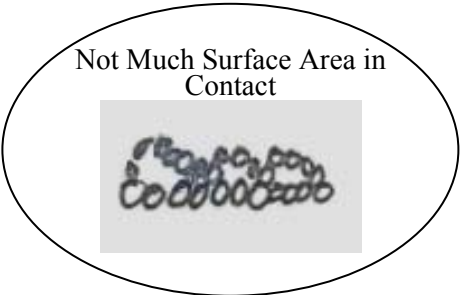
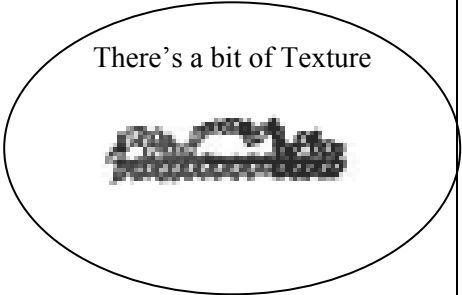
**Table 5-25: Associations made by students in the Metal Blocks activity**

<b>Metal Blocks Activity (Prediction)</b>		
<i>Lynn</i>	<i>Jeff</i>	<i>Meg</i>
<pre> graph TD     A([Rougher Side]) &lt;--&gt; B([Greater Friction Force])         </pre>	<pre> graph TD     A([Rougher Side]) &lt;--&gt; B([Greater Friction Force])         </pre>	<pre> graph TD     A([Smooth Sides]) &lt;--&gt; B([Close Together])     B &lt;--&gt; C([Bond Together])     C &lt;--&gt; D([Harder to Move])         </pre>
<b>Metal Blocks Activity (Explanation)</b>		
<i>Lynn</i>	<i>Jeff</i>	<i>Meg</i>
<pre> graph TD     A([Smooth on Smooth]) &lt;--&gt; B([Form Bonds])     B &lt;--&gt; C([Interlock])     B &lt;--&gt; D([Forces that hold molecules together])     C &lt;--&gt; E([Greater Friction])         </pre>	<pre> graph TD     A([Smooth on Smooth]) &lt;--&gt; B([More Surface Area Interacting])     B &lt;--&gt; C([Harder to Pull])         </pre>	<pre> graph TD     A([Smooth on Smooth]) &lt;--&gt; B([No Spaces in Between])     B &lt;--&gt; C([Bond])     C &lt;--&gt; D([Greater Friction])     C &lt;--&gt; E([Sharing of electrons])         </pre>

**Table 5-26: Associations made by students in the Graphing of Friction vs. Roughness of Surfaces activity**

Graphing of Friction Force vs. Surface Roughness			
Lynn	Jeff	Meg	
<p>Graph of Friction Force vs. Roughness of Surfaces</p> 	<p>Graph of Friction Force vs. Roughness of Surfaces</p> 	<p>Graph of Friction Force vs. Roughness of Surfaces</p> 	<p>Graph of Friction Force vs. Roughness of Surfaces</p> 

**Table 5-27: Associations made by students during the Sketching of Pairs of Sliding Surfaces**

<b>Sketches of Pairs of Sliding Surfaces</b>		
<i>Lynn</i>	<i>Jeff</i>	<i>Meg</i>
<p>Uncrumpled Paper over the Transparency</p> <p>↕</p> <p>Stick Together</p> 	<p>Uncrumpled Paper over the Transparency</p> <p>↕</p> <p>Atoms Bond(Overlap)</p> 	<p>Uncrumpled Paper over the Transparency</p> <p>↕</p> <p>Stuck Together More</p> 
<p>Crumpled Paper over the Transparency</p> <p>↕</p> <p>Not Much Surface Area in Contact</p> 	<p>Crumpled Paper over the Transparency</p> <p>↕</p> <p>Not Much Surface Area in Contact</p> 	<p>Crumpled Paper over the Transparency</p> <p>↕</p> <p>There's a bit of Texture</p> 

**Table 5-28. Explanations of the Metal Blocks Activity after doing the Papers & Transparency**

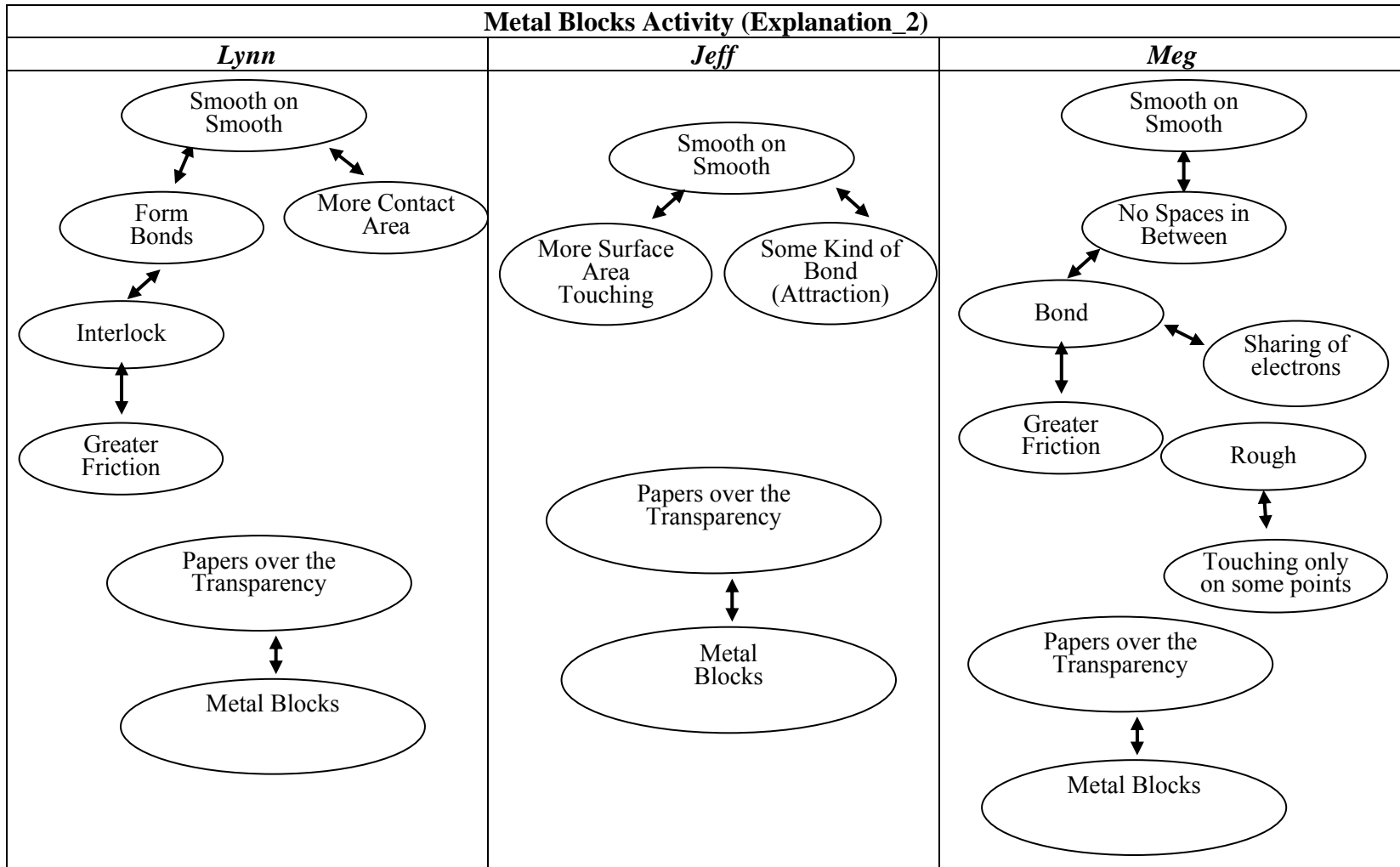
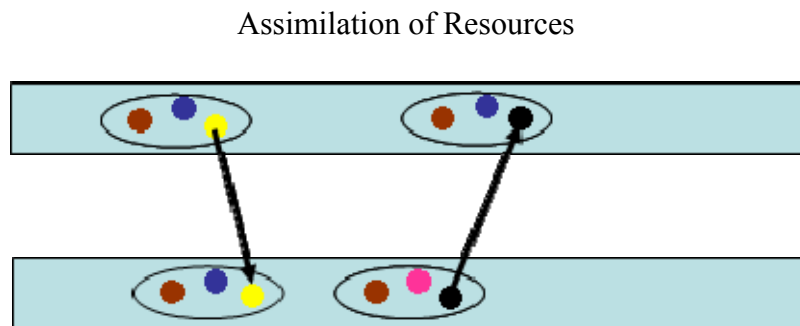


Figure 5.19 shows the dynamics of their model construction in terms of explaining the metal blocks activity. In the figure, the dots represent the resources that students bring out during the teaching interview. The arrows linking two dots mean that the resource is being assimilated. For example, the resource represented by yellow dot was brought out by student A in explaining something and later was assimilated by student B. In the interaction observed among Meg, Jeff and Lynn each one of them try to assimilate resources which they find essential in improving their model. For example, when the students were asked to predict how the forces would compare when the different pairs of surfaces (smooth on smooth vs. smooth on rough) are slid across each other, we see in Table 5-25 that Meg brought out the association of bonding of atoms with the case of the smooth on smooth sides. This association was then used by Lynn in explaining the observation that it was harder to move the smooth across the smooth metal block sides. Jeff however, made the association of more surface area interacting with the smooth on smooth case. But later in the interview, Jeff also adopted the use of “bonding of atoms” explanation in explaining his observation on the papers & transparency activity (see Table 5-27). Finally, when they were asked explicitly to make sense of what was going on with the metal blocks the students converged on the associations of the smooth on smooth with greater area of contact and some kind of bonding involved (see Table 5-28).

In terms of the complexity of the associations that the students brought out and the internal resources that students were activating it was evident that Lynn, Jeff & Meg are at the same Zone of Proximal Development (ZPD). It appears from this analysis, that groups of students who are the in the same ZPD are likely to converge on the same pictorial representation and explanations.

**Figure 5.19: The Dynamics of Model Construction of Meg, Lynn & Jeff**



#### **5.5.4.2 Group Teaching Interview- The Case of Gerald & Matt**

Gerald is majoring in electrical engineering and Matt is a chemical engineering major. They were both currently enrolled in first semester calculus-based physics course. In terms of explaining the phenomena under investigation, Matt was the more articulate and talkative between the two. In most instances, Gerald appeared to be merely concurring with what Matt was saying and did not offer any alternative explanations.

Again in terms of the representation of smooth and rough surfaces (see Table 5-29), the associations made by Matt and Gerald are exactly the same as those of other students interviewed. As can be seen in Table 5-30 both students associate increasing roughness with increasing friction.

Table 5-31 shows the students' predictions and explanation in the metal blocks activity. During the interview Matt always tended to provide explanations first. In fact, the interviewer had to ask Gerald about his thoughts to encourage him to talk. It can be seen from the table that students predicted that there will be more friction on the rough side because there will be more jags on it. When they were asked to explain their observation that it was actually harder to move the smooth surface across the other smooth surface, Matt started out by talking how friction is independent from the surface area and all that matters is the type of surfaces rubbing. But he later said that at the atomic level the contact area can make a difference as he made an analogy with roller blades.

*“Friction was independent of surface area because you know, I don't remember how it goes, but as you increase the surface area the number of jags in contact, the ratio of those jags to something else kept the friction force the same. All that*

*matters was the type of surface that you are rubbing with...at the atomic level can make a difference I think... on the atomic level, the idea of friction is that the particles that are touching each other, resist each other and so, if you got, it's kinda like if you try to go down a slide, go down a water slide and you go down flat you go a lot slower than if you raise yourself up on your roller blades, because these little points (points to sketch) have less friction than the whole surface as a whole."*

At this point of the teaching interview Matt started to dominate the discussion. Later in the teaching interview Matt, made a very plausible explanation of what is happening between the smooth metal block surfaces. He was the only student to talk about dipole interactions and explain his model to a significant level of detail:

*"When you bring metals together, you can create kind of a little bit of dipole because of its electrons. So one side can be plus and one side can be minus. And when you bring them together, this side can be minus and this side can be plus, and so they stick together. And that's what I think you were saying. And then when you have one that is really is smooth you have a lot of surface area where you've got the charges attracting each other and then when you have little surface area you have plus and a minus here, plus and minus here, plus and a minus here, which will quite work so well for metals, but for like plastics like carbon and hydrogen have almost no dipole between them. Because most plastic are like silica plastic, so like a hydroxide does not dipole in between the two, so that you don't get these interactions as well on the atomic level."*

It is clear that Matt was able to resolve the conflict in the metal blocks activity by activating reasoning resources from his previous experiences including what he had possibly learned in previous classes.

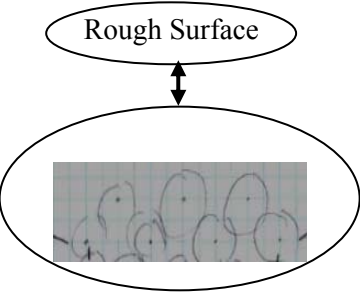
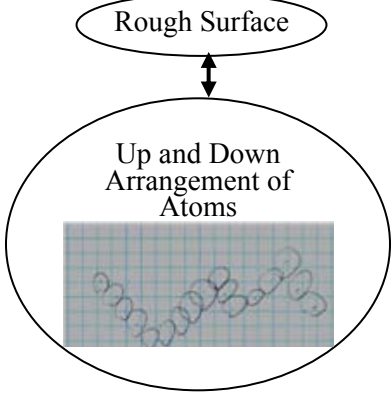
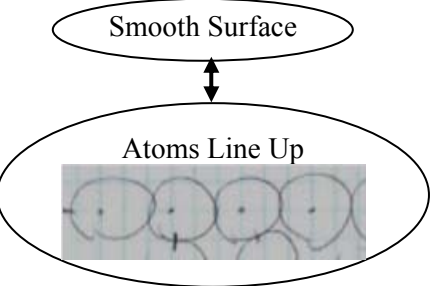
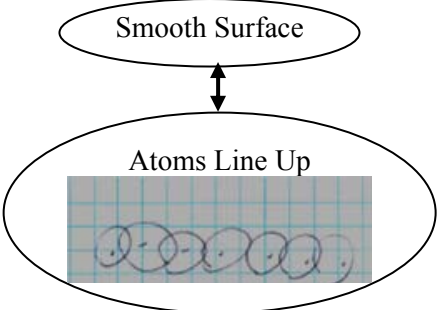
Before completing the papers and transparency activity, both Gerald and Matt were already talking about the role of bonding of atoms as explanations for their observation on smooth on smooth. This implies that students when in a state of cognitive conflict can appropriately resolve it by themselves provided that they already possess the appropriate reasoning resources that they can activate to resolve the conflict. In other words, in some case, the appropriate reasoning resources, if they exist, can be activated in response to a discrepant event. For most students we can see that the papers and transparency activates students' resources about charges. The quality of their explanations obviously depends on the span of their knowledge about charges and their interactions. It is apparent that those students with broader span of knowledge about charges and their interactions tended to make more scientific



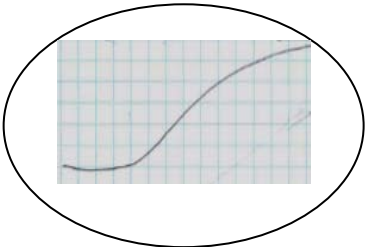
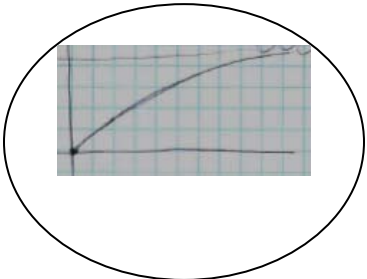
explanations about the phenomena observed. In other words a broader span of knowledge of charges and interactions corresponded to a wider zone of proximal development because it afforded these students the cognitive resources with which they could construct their new model. Thus, how far we can facilitate their model building process greatly depends on their internal knowledge which in turn is related to their zone of proximal development.

In Table 5-31 we can see that Gerald simply just concurred with Matt's modified graph of friction versus roughness of the surfaces. In the case where the ZPD's of the students do not overlap, one could be dominating the discussion and the other student would tend to shy away from collaborating in the model-building process. In such a case, the dynamics of their interaction would likely resemble the one depicted in Table 5.20.

**Table 5-29: Associations made by students in Activity 1 (Feeling & Sketching of Surfaces)**

<b>Rough Surfaces</b>	
<i>Matt</i>	<i>Gerald</i>
<p>Rough Surface</p> 	<p>Rough Surface</p> <p>Up and Down Arrangement of Atoms</p> 
<b>Smooth Surfaces</b>	
<i>Matt</i>	<i>Gerald</i>
<p>Smooth Surface</p> <p>Atoms Line Up</p> 	<p>Smooth Surface</p> <p>Atoms Line Up</p> 

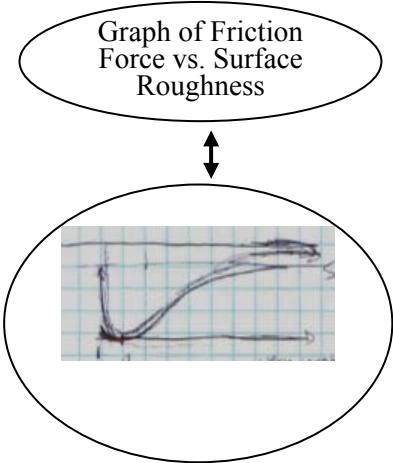
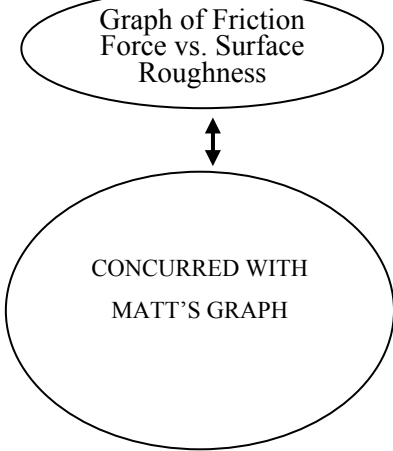
**Table 5-30: Variations in the associations made by students in the Graphing of Friction Force vs. Roughness activity**

<b>GRAPH OF FRICTION VS. ROUGHNESS OF SLIDING SURFACES</b>	
<i>Matt</i>	<i>Gerald</i>
<p>Graph of Friction Force vs. Surface Roughness</p> 	<p>Graph of Friction Force vs. Surface Roughness</p> 

**Table 5-31: Associations made by students in the Metal Blocks Activity**

<b>Metal Blocks Activity (Prediction)</b>	
<i>Matt</i>	<i>Gerald</i>
<pre> graph TD     A(Rougher Side) &lt;--&gt; B(More Catching of Jags)     B &lt;--&gt; C(Greater Friction Force)             </pre>	<pre> graph TD     A(Rougher Side) &lt;--&gt; B(More Catching of Jags)     B &lt;--&gt; C(Greater Friction Force)             </pre>
<b>Metal Blocks Activity (Explanation)</b>	
<pre> graph TD     A(Atoms more aligned) &lt;--&gt; B(Smooth on Smooth)     A &lt;--&gt; C(More Tendency to Bond (Metallic Bonds))     C &lt;--&gt; D(Dipole Interaction)     E(Touching Only on Few Points) &lt;--&gt; F(Smooth on Rough)     E &lt;--&gt; G(Less Friction)             </pre>	<pre> graph TD     A(Atoms more aligned) &lt;--&gt; B(Smooth on Smooth)     A &lt;--&gt; C(More Tendency to Bond)     C &lt;--&gt; D(Greater Force)             </pre>

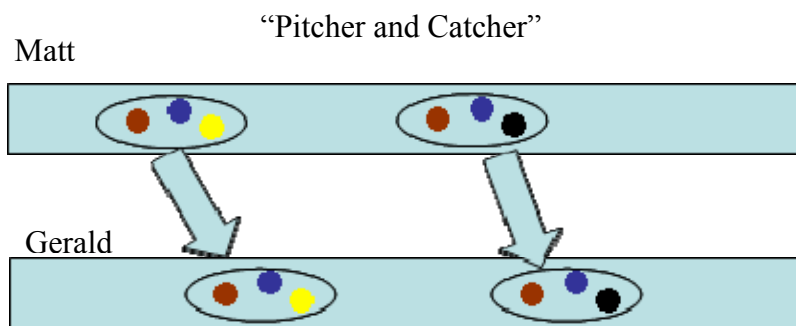
**Table 5-32: Associations made by students in the “Modifying Graph of Friction Force vs. Roughness” Activity**

<b>MODIFYING GRAPH OF FRICTION FORCE VS. ROUGHNESS OF SLIDING SURFACES</b>	
<i>Matt</i>	<i>Gerald</i>
<p>Graph of Friction Force vs. Surface Roughness</p> 	<p>Graph of Friction Force vs. Surface Roughness</p> <p>CONCURRED WITH MATT'S GRAPH</p> 

During the course of the teaching interview, Matt was more elaborate with his explanations. Most of the associations made by Gerald were picked up from Matt. We can see here a case where one of the students basically dominated the teaching interview and the other student appeared to be simply at the receiving end accepting inputs from the first student. In fact toward the end of the interview (modifying graph) Gerald tended to just concur with Matt's explanations. This dynamics of interaction as Matt and Gerald worked on the activities is depicted in

We can see that the students start out with their own associations. The figure illustrates how in general they interacted and made use of the inputs from each other. As the interview progressed, Matt tended to be providing more inputs which caused Gerald to be at the receiving end and just simply concurring with the ideas brought out by Matt. This mode of interaction is what I call the “*pitcher & catcher*” mode of interaction, where in this case of the teaching interview, Matt provides the input and Gerald was merely “catching” these inputs.

Figure 5.20: The Dynamics of Interaction between Matt and Gerald



#### 5.5.4.3 Group Teaching Interview- The Case of Arthur & Nathan

In this section the case of two students, Arthur & Nathan is presented in order to show yet another variation in the kinds of interaction between two students as they go through a series of modeling activities. Both students were currently enrolled in second-semester calculus-based physics. Arthur was majoring in electrical engineering while Nathan was majoring in chemical engineering. Table 5-33 through Table 5-38 show the variations in the associations between the two students. Again we see that these two students also made the same associations as the other groups in terms of the sketch of smooth and rough surfaces at the atomic level (see Table 5-33).

In terms of their associations they made in explaining the friction between the wooden block dragged across the wooden plank, we can see in Table 5-34 that Arthur made the association of the friction with the electrical interactions of the atoms and subsequently with the electrostatic force. It is very likely that Arthur made these associations based on the previous activity on the sketching of the surfaces. Nathan however, made the associations of friction with the physical interlocking of bumps and valleys and also with skidding of atoms over the tops of other atoms.

They were then asked to make predictions on what they thought would happen to the friction force when the same wooden block is dragged across the sandpaper surface. Their associations are depicted also in Table 5-35. We can see that the two students actually switched their models of explanations. Arthur picked up on Nathan's earlier association and predicted that there will be more force on the sandpaper because the sandpaper has deeper pits and it would require higher energy to lift them up from the pits. Meanwhile, Nathan picked up on Arthur's earlier association of friction with electrical interactions in predicting that there will be more force on the sandpaper because it will involve breaking of the crystalline structure of the wood, which would likewise involve breaking of the bonds between atoms.

When the students were asked to explain how friction is produced in between the surfaces based on their sketches at the atomic level we see in Table 5-36 that Arthur is sticking to the "physical interaction" explanation which he earlier picked up from Nathan while Nathan is sticking to the "electrical interaction" explanation which he earlier picked up from Arthur. According to Arthur

*"...I think that friction just comes from the collisions of the atoms. So if it can't get past that's causes friction cause there's an atom on the way."*

When the two students were asked to again go back to the case of the metal block and explain their observations, both of them actually converged to the "electrical interaction" explanation (see Table 5-37). Both students associated the case of the smooth on smooth metal block surfaces with atoms closer to each other and that there's more contact area. Furthermore, Arthur made the association between more contact area and more atoms in contact which was subsequently associated with more interactions between positive and negative charges which would produce more friction. According to Arthur

*“...there's some attraction apparently between these two surfaces 'cause I can pick them up by holding on to this one. So, that's what is causing it to be harder. ..if it is smoother on these surfaces that would mean more total contact area....the closer they are together, the stronger would be the interaction between them, so this ones (smooth on rough) would be further away even though they have a negative charge. So, this (smooth on smooth) would like you know have two times the charge so there will be more interaction between the positives and the negatives.”*

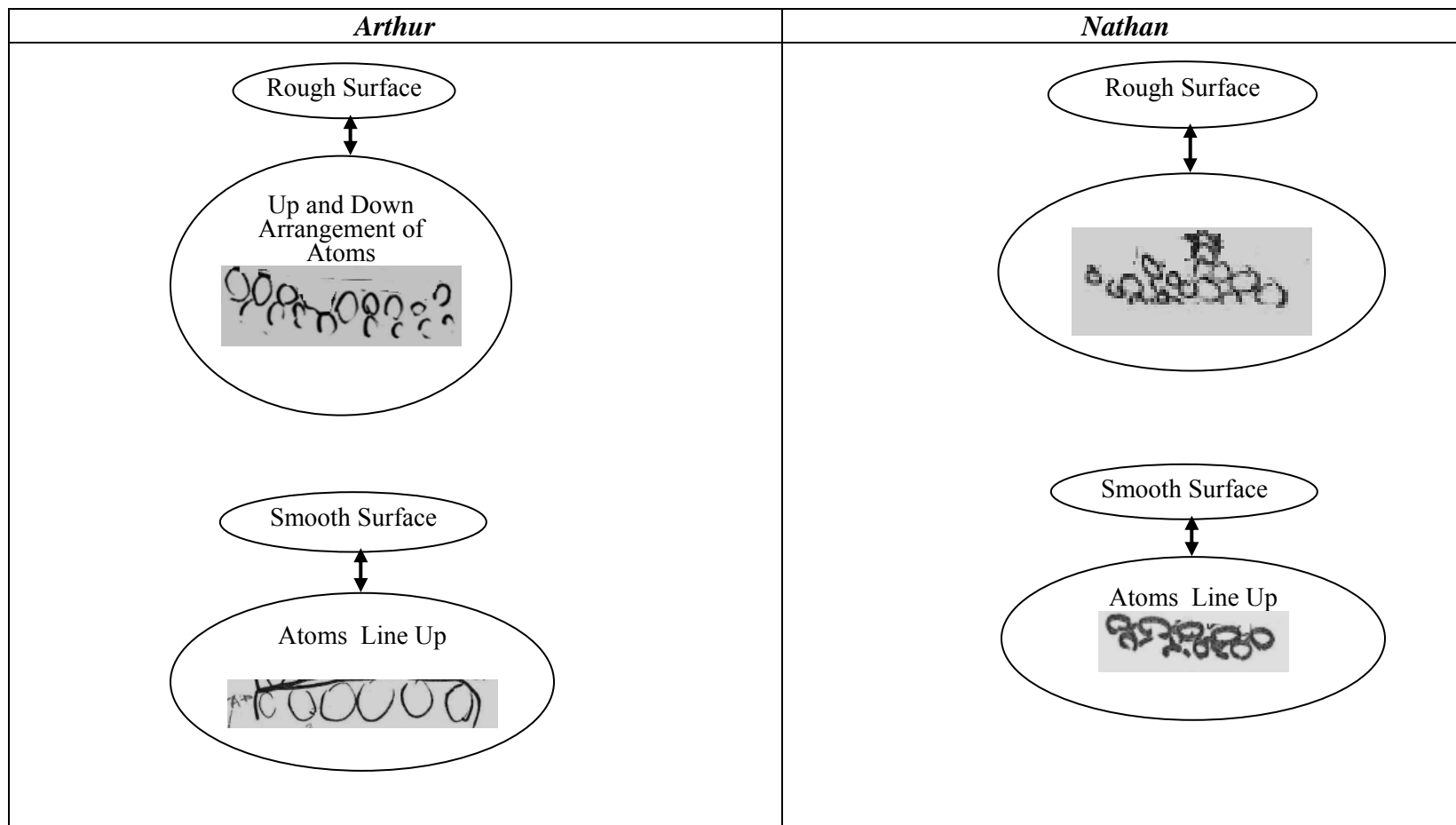
Meanwhile, according to Nathan in the case of the smooth on smooth the surfaces would be sharing electrons with each other, this is also true with the other pairs of surfaces but there is more sharing of electrons on the smooth on smooth surfaces because of greater contact area. According to Nathan:

*“For the top of the metal you've got instead of having the electrons you've got the free electrons that go in the metal so they are kinda free to move around or whatever. And uhh I think that once you get close enough together, you might get close enough to where, uhh, the same kind of thing that moves the electrons on the surface, tries to move these electrons across. Maybe further across, moving them to where these two surfaces (smooth on smooth) are sharing these electrons. So you have two flat surfaces like that with those free electrons this kind of sharing with each other. For the smooth and rough sides there is not much.”*

Table 5-36 shows the graph that they associate with the variation of friction with the roughness of the surfaces. It is apparent from their sketches that these students are making the associations between increasing roughness with increasing friction and increasing smoothness with decreasing friction.



**Table 5-33. Association made in explaining their observations in dragging the wooden block across wooden plank.**



**Table 5-34: Associations made from the Wooden Block Activity**

<b>Dragging of Wooden Block Across Wooden Plank (Explanation)</b>	
<i>Arthur</i>	<i>Nathan</i>
<pre> graph TD     A([Friction]) &lt;--&gt; B([Electrical Interaction of Atoms])     B &lt;--&gt; C([Electrostatic Force])     </pre>	<pre> graph TD     A([Friction]) &lt;--&gt; B([Interlocking of bumps &amp; valleys])     A &lt;--&gt; C([Skidding along the tops])     </pre>
<b>Dragging of Wooden Block Across Sandpaper Surface (Prediction)</b>	
<i>Arthur</i>	<i>Nathan</i>
<pre> graph TD     A([Sandpaper]) &lt;--&gt; B([Deeper Pits])     B &lt;--&gt; C([Higher Energy])     C &lt;--&gt; D([More Force to Pull])     </pre>	<pre> graph TD     A([Sandpaper]) &lt;--&gt; B([Breaking of Crystalline Structure])     B &lt;--&gt; C([Breaking of Bonds])     C &lt;--&gt; D([More Force to Pull])     </pre>

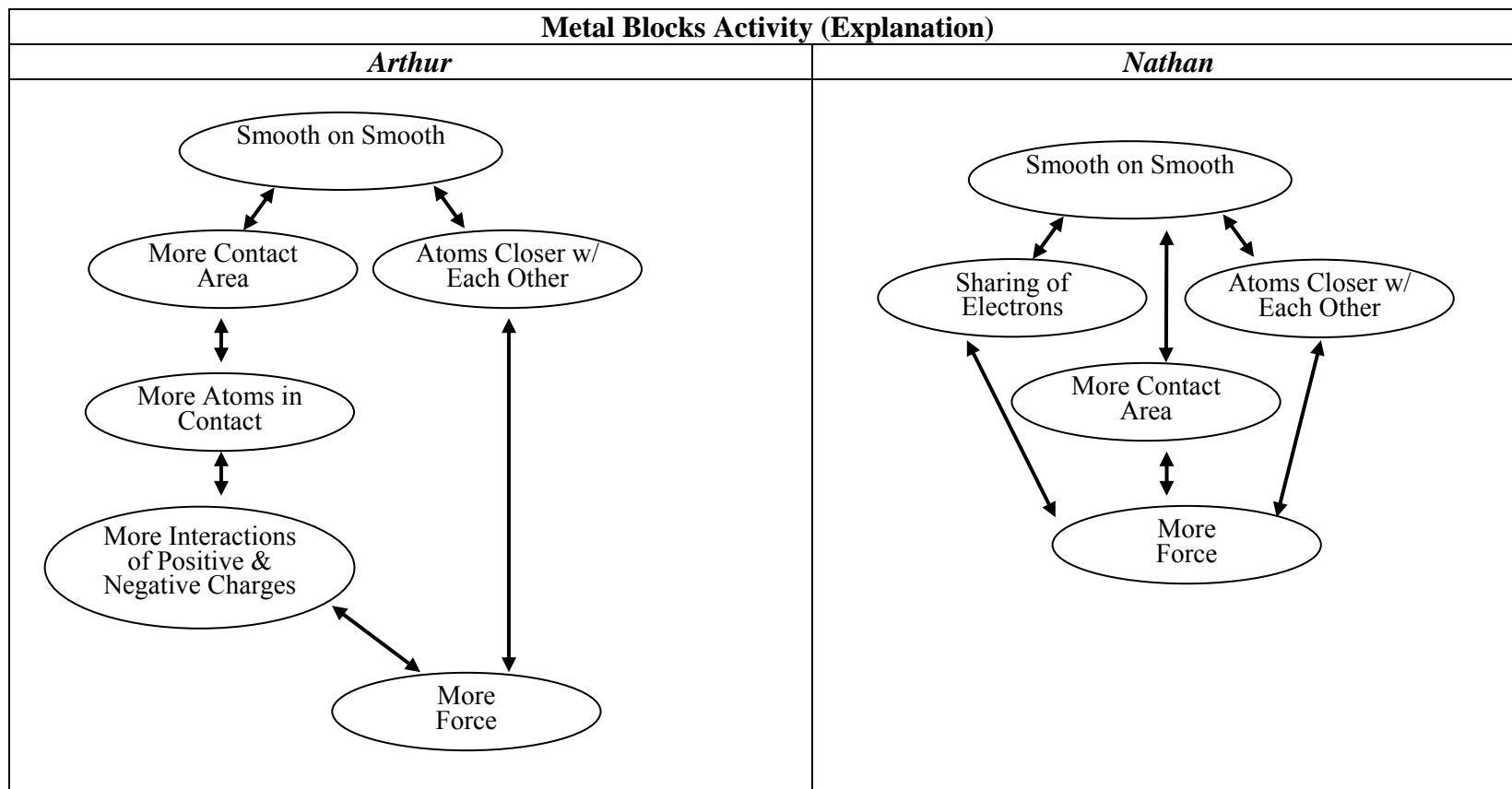
**Table 5-35: Associations made by students in the Graphing of Friction vs. Roughness of Surfaces**

<b>Graphing of Friction Force vs. Surface Roughness</b>	
<i>Arthur</i>	<i>Nathan</i>

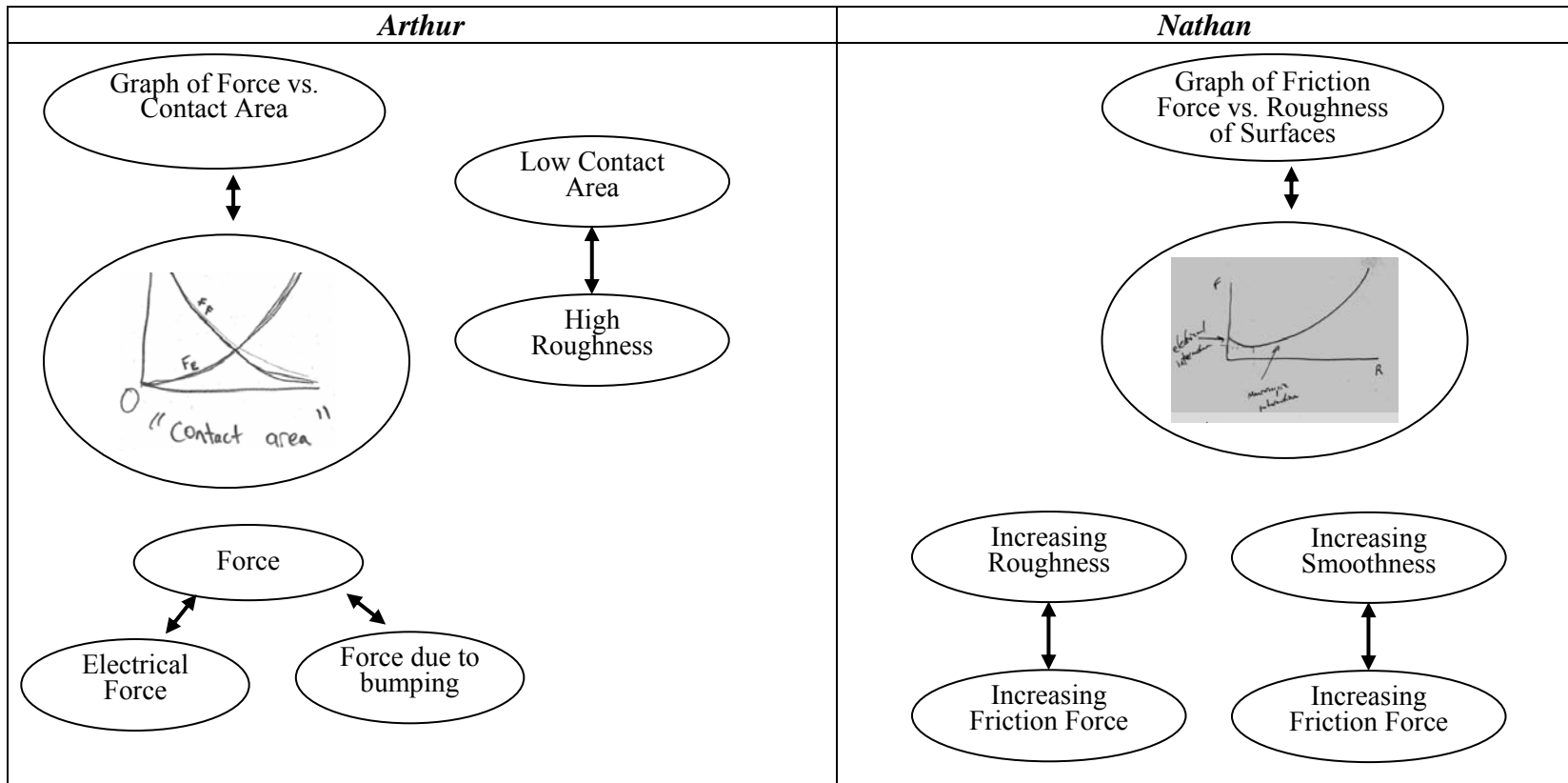
**Table 5-36: Associations made by students after the Activity on Sketching the Pairs of Sliding Surfaces**

<i>Arthur</i>	<i>Nathan</i>

**Table 5-37: Associations made by students after the Metal Blocks Activity**



**Table 5-38: Associations made by students in the Graphing of Friction vs. Roughness of Surfaces activity**

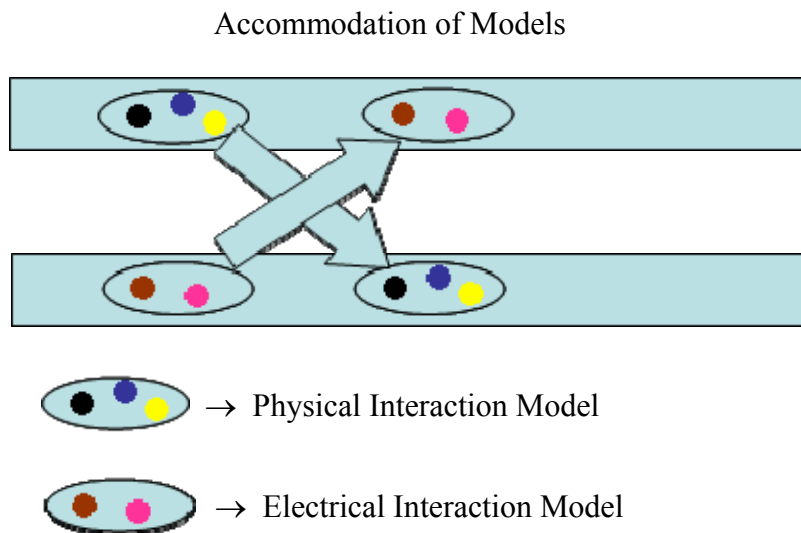


So, we see here that Arthur at this point went back to his prior associations with friction that it is caused by electrical interactions. While in the case of Nathan, the “electrical interaction” association seemed to make sense to him in the light of the activities investigated so he stuck to it.

In Table 5-38 we can see the associations made by the students when they were asked to modify their earlier graphs of friction with the roughness of both surfaces. We can see that Arthur preferred to graph the friction force in terms of the contact area instead of the roughness. According to him high roughness is associated with low contact area. Furthermore, he associated friction force with an electrical force and the force due to bumping. At this point he was making a conceptual blend of his earlier association (friction with electrical interactions) with the association he picked up from Nathan (friction with physical interaction). In similar fashion, Nathan also made a conceptual blend with his previous association (friction with physical interaction) with the association he picked up from Arthur (friction with electrical interactions) in coming up with his modified graph of friction with the roughness of the surfaces.

The dynamics of the interaction between Nathan and Arthur is diagrammatically illustrated in Figure 5.21. As discussed above Nathan started out associating friction with electrical interaction while Nathan started out with the association of friction with physical interaction (interlocking of bumps and valleys and skidding on tops). Afterward the two students switched models of explanations when they were asked to predict what happens to the friction force when the wooden block is dragged across the sandpaper surface (Table 5-34) and when they were asked again to talk about the cause of friction after they made sketches of the pairs of sliding surfaces (Table 5-36). However, on the part where they modified their graphs both students came up with a new model of friction represented by the U-shaped graph. The students essentially created a conceptual blend of their initial associations with the associations picked from their co-member. Moreover, Figure 5.21 provides a picture on the possible dynamics of construction with students at the same zone of proximal development.

**Figure 5.21. Dynamics of Model Construction of Nathan and Arthur**



**5.5.4.4 Group Teaching Interview: The case of Emily and Jacob**

Table 5-39 to Table 5-44 depict the association made by the two students as they went through the teaching interview. It can be seen from Table 5-39 that Emily associated rough surfaces with atoms arranged in up and down manner while Jacob associated rough surfaces with atoms that are spaced out. In explaining their observation on the dragging of the wooden block, Emily associated friction with molecules getting caught with each other, while Jacob associated more friction with atoms that are more spaced out. When they were asked to graph friction versus the roughness of the surfaces (see

<b>Dragging of Wooden Block Across Wooden Plank (Explanation)</b>	
<i>Emily</i>	<i>Jacob</i>

--	--



Table 5-41). It is interesting to note that Jacob, made a u-shaped graph and made the association of increasing smoothness with increasing friction. This has not been observed in other teaching interviews. Meanwhile, Emily made the typical graph of linear variation of friction with the surface roughness.

In explaining the metal blocks activity (see Table 5-42), Emily initially associated it with some kind of seal. But for Jacob, he associated the force on the smooth sides with them completely touching each other. This eventually influenced Emily to associate the force on the smooth and smooth with the contact area and displaces the association of force with atoms getting caught.

Table 5-43 depicts the associations of the students during the papers and transparency activity. It can be seen that the two students made different associations. At this point Jacob displaces his association of surface area with friction. Emily on the other hand still applies the

association of friction with surface area together with the association of the force with charges closer to each other..

Lastly,

in

Table 5-44 we see that Emily modified her initial graph to the u-shaped type of graph. Meanwhile, Jacob just stick on to his initial graph. For Emily, he incorporated in his schema the association of increasing friction with increasing smoothness.

Figure 5.22 depicts the interaction of Emily and Jacob as they went through the model building activities. It is clear from the analysis of the video that Emily tended to assimilate some of the inputs provided by Jacob but not the other way around. This type of interaction is what I am referring to as a one-way assimilation of resources. The other student was not influenced in any way by the ideas of the other student.

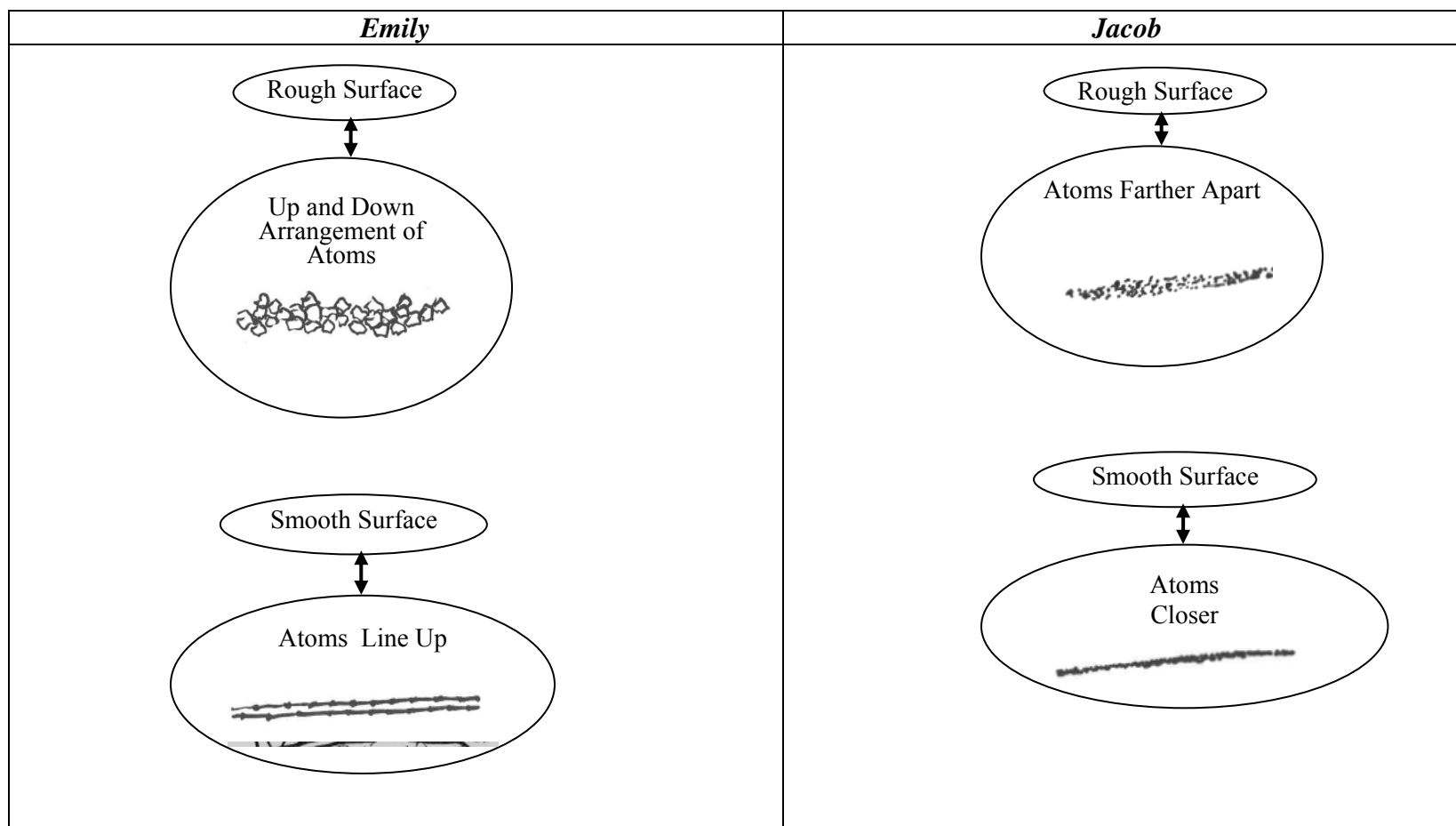
At one point of the interview, Emily said

*“I think I have to change my mind again. Earlier I said that surface area does not matter, I think it actually does. Part of the reason why area does not matter is the equation  $f$  equals  $\mu$  times the normal force. But I think  $\mu$  takes into account what the surface area is, how of the surface is touching down. I think we will have different  $\mu$  for this (flat paper) than with this (crumpled paper). I think the surface touching takes into account. That’s I guess what we have been talking about. That if you have more surface interacting you get more friction.”*

Emily seemed to be providing a very plausible explanation for the papers and transparency but Jacob seemed to ignore it. His response at this point of the teaching interview was

*“I will stick to the fact that surface area doesn’t have an effect on the force. I would think that there is more contact on the flat paper but the friction force was still the same because we still have the same weight. If you look at this equation, we did not change the coefficient of friction and we did not change the normal force so the friction is still the same. Because coefficient of friction is just based on the type of surfaces. Even though there’s a change on the contact area we did not change the paper. If you are questioning that equation ( $f = \mu N$ ) you are basically questioning how friction works and basically you can’t do that. That is pretty absolute, like relativity is.”*

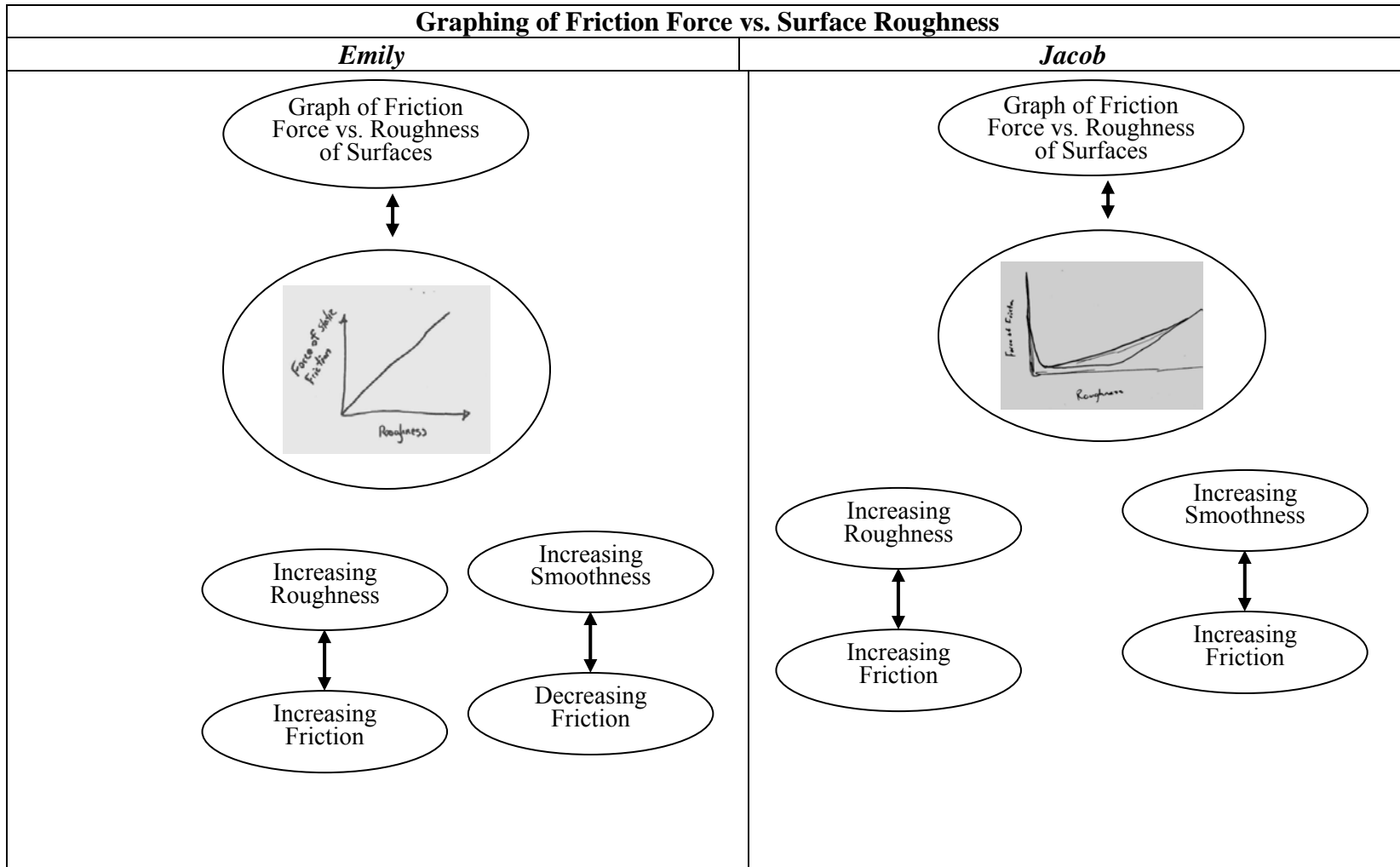
**Table 5-39. Association made in explaining their observations in dragging the wooden block across wooden plank.**



**Table 5-40: Associations made from the Wooden Block Activity**

<b>Dragging of Wooden Block Across Wooden Plank (Explanation)</b>	
<i>Emily</i>	<i>Jacob</i>
<pre> graph TD     A(Interaction of Molecules) &lt;--&gt; B(Friction)     A &lt;--&gt; C(Getting Caught w/ Each Other)             </pre>	<pre> graph TD     A(Sandpaper) &lt;--&gt; B(Atoms Farther Apart)     B &lt;--&gt; C(More Interactions)     C &lt;--&gt; D(More Friction)             </pre>

**Table 5-41: Associations made by students in the Graphing of Friction vs. Roughness of Surfaces**



**Table 5-42: Associations made by students after the Metal Blocks Activity**

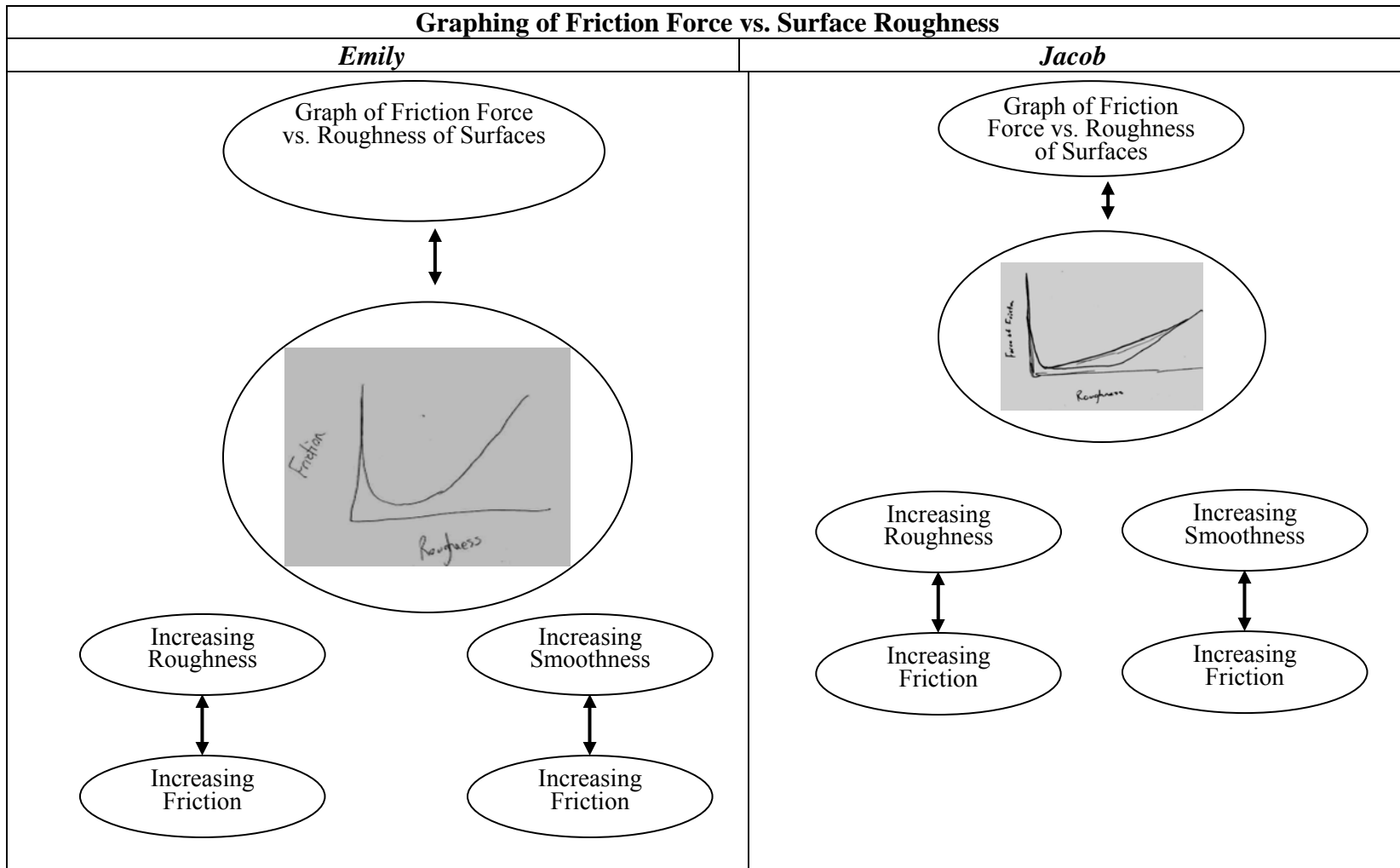
<b>Metal Blocks Activity (Explanation)</b>	
<i>Emily</i>	<i>Jacob</i>
<pre> graph TD     A([Smooth on Smooth Metal Blocks]) &lt;--&gt; B([Some Kind of Seal])         </pre>	<pre> graph TD     A([Smooth on Smooth]) &lt;--&gt; B([Straight Line])     A &lt;--&gt; C([Completely Touching])     B &lt;--&gt; D([Interlock Completely])         </pre>
<pre> graph TD     A([Smooth on Smooth]) &lt;--&gt; B([Everything in Contact])     A &lt;--&gt; C([Atoms Getting Caught])     B &lt;--&gt; D([Creates Lot of Friction])     C -.-&gt; E[ ]         </pre>	

**Table 5-43: Associations made by students in the Papers & Transparency Activity**

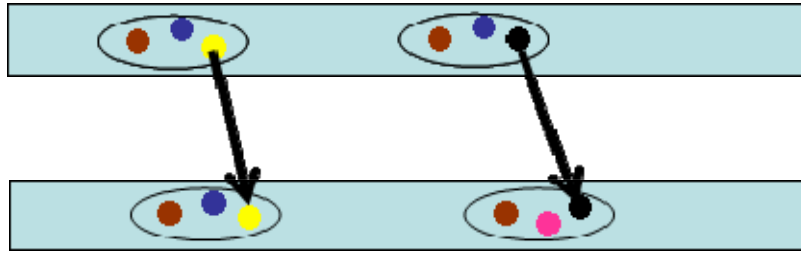
<i>PREDICTIONS</i>	
<i>Emily</i>	<i>Jacob</i>
<pre> graph TD     A([Uncrumpled Paper]) &lt;--&gt; B([More Contact Area])     B --&gt; C([More Friction])         </pre>	<pre> graph TD     A([Friction Force]) &lt;--&gt; B([Surface Area])         </pre>
<i>EXPLANATIONS</i>	
<i>Emily</i>	<i>Jacob</i>
<pre> graph TD     A([Uncrumpled Paper]) --&gt; B([More Area in Contact])     A --&gt; C([Charges Closer to Each Other])         </pre>	<pre> graph TD     subgraph Left         A([Uncrumpled Paper]) &lt;--&gt; B([More Attraction of Charges])     end     subgraph Right         C([Friction Force]) &lt;--&gt; D([Surface Area])     end         </pre>



**Table 5-44. Associations made in Modifying the Graph of Friction Force vs. Surface Roughness**



**Figure 5.22. One-way Assimilation**



#### ***5.5.4.5. Group Teaching Interview: Further Explored***

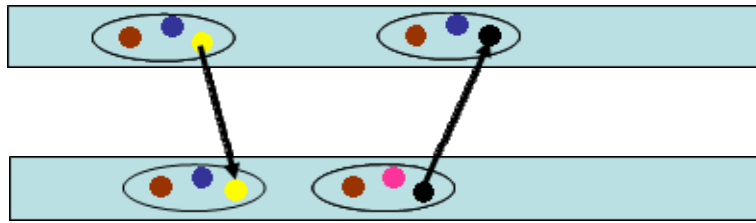
Ten (10) group teaching interviews were conducted in order to investigate the dynamics of students' interactions as they worked in groups. The variations in the interactions are depicted in Figure 5.23 and Figure 5.24 . The ovals represent the models while the dots represent the resources. Results suggest that there are two themes emerging in terms of the participation of students – balanced and unbalanced participations.

In the balanced participation, three variations were observed. First is the group where they tended to assimilate the resources that were provided by their peers (see Figure 5.23A). An example of this interaction is the case of Meg, Jeff and Lyn. A second variation that was observed is illustrated by the case of Nathan and Arthur. In this type of interaction the students tended to accommodate each other's initial model as they went through the series of the model-building activities (see Figure 5.23B). Figure 5.23C illustrates the third variation of interaction that was observed. In this case a student proceeded with the model-building process without assimilating or accommodating the inputs provided by his/her peers. His/her explanations were not influenced by his/her peer's explanations. He/she just proceeded in the teaching interview as if the other student was not there.

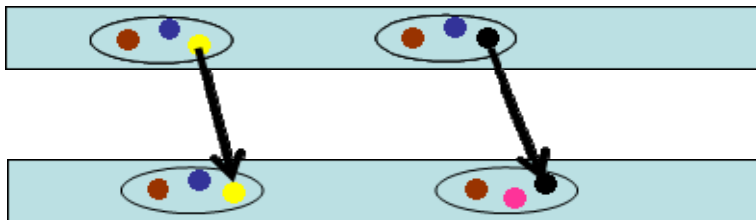
In the unbalanced participation (see), a member of the group would tend to dominate the discussion and the other member/s would tend to simply receive and accept inputs from the “dominant” student. The imbalance in participation can be caused by the difference in breadth of knowledge of the students as in the case of Matt and Gerald.

**Figure 5.23. Balanced Participation**

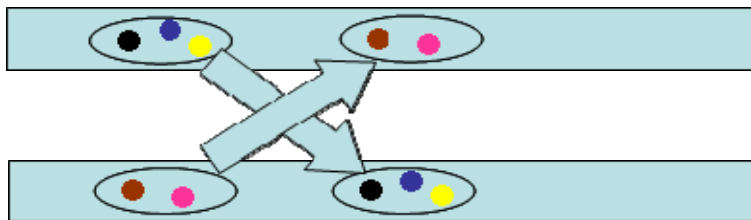
A. Intra-Group Assimilation of Resources



B. One-Way Assimilation of Resources

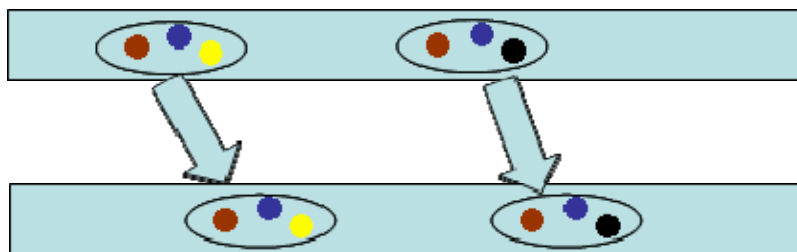


C. Accommodation of Models



**Figure 5.24. Unbalanced Participation**

“Pitcher and Catcher”



## 5.6 Chapter Summary

In this chapter the research questions, methodology, data gathering procedures, and the results of the second phase of the study are discussed. The intent of the second phase of this research is to investigate the dynamics of students' knowledge construction and reconstruction in the context of microscopic friction. Individual and group teaching interviews were conducted with different streams of students in order to investigate what scaffolding (cues, hints, activities, and other external inputs) cause them to reorganize their knowledge about microscopic friction and the extent to which they utilize these scaffolding. The group teaching interviews were primarily conducted in order to investigate the dynamics of students' interactions as they go through a series of model-building activities.

A phenomenographic approach of data analysis was employed in establishing the variations in students' associations in the different stages of the teaching interview. Results show that a vast majority of the students associate rough surfaces with a zig-zag arrangement of atoms and smooth surface with atoms lining up. Also, most students also start out with associating increasing roughness with increasing friction and increasing smoothness with decreasing friction. The scaffolding activities build on these associations in order to guide their model construction and reconstruction of microscopic friction. Through the metal blocks activity students are put into a state of cognitive conflict in that their prior associations with increasing roughness with increasing friction fail to explain their observation that it was harder to move the smooth on smooth metal block surfaces compared to the smooth on rough metal block surfaces. The papers and transparency activity helped them resolve this conflict. The papers and transparency led students to associate the force to pull with charges, and demonstrated that the increasing contact area is associated with increasing force.

In constructing their models of microscopic friction, the analysis suggests that students undergo the processes of incorporation and displacement (diSessa & Wagner, 2005). We have also observed the processes of incremental change and dual construction (Wittmann, 2006) occurring as students construct and reconstruct their ideas about microscopic friction. Moreover, it was found that with respect to some target ideas (friction varies as the U-shaped graph) that virtually all of the students seem to be in the same Zone of Proximal Development. These students with different physics backgrounds have the necessary internal knowledge in activating

the appropriate associations with respect to this target idea. However, these students are at different ZPDs with respect to their mathematical model

$$f = \mu N + cA \quad (5.3)$$

The extent to which students utilize the scaffolding activities greatly depends upon the span of their knowledge which subsequently affects their zone of proximal development.

In terms of the dynamics of interactions between students working in small groups, balanced and unbalanced participations were observed. For the balanced participation three variations were noted – intra-group assimilation of resources, one-way assimilation of resources and assimilation of models. Meanwhile one case is observed for the unbalanced participation- “the pitcher and catcher” type of interaction. These results suggest that the intra-group assimilation of resources and assimilation of models would likely to occur if students are at the same zone of proximal development (ZPD). The “pitcher and catcher” type of interaction is more likely to occur if students are at a different ZPD.

In the next phase of research the results of the teaching interview were used to develop an instructional module as well as formative and summative assessment tasks. In the next chapter the creation of these instructional materials is presented along with the results of a pilot-test of these materials and its impact on student learning and attitudes.

## **CHAPTER 6 - Development, Evaluation & Pilot-Testing of the Instructional Materials**

### **6.1 Introduction**

This chapter presents the development, formative evaluation and pilot-testing of the instructional activities on microscopic friction. It concludes with a discussion of the results in the formative evaluation and pilot-testing of the developed sequence of activities.

### **6.2 Methodology**

In the third phase of this study, action research methodology was adopted. Action research is a circular process that involves planning and executing interventions to produce change in the setting under study and evaluate the impact of change (Holloway, 1997).

It was found in the first phase of the study that students resort to macroscopic mechanical explanations to explain microscopic friction. Based on this result, in the second phase of the study teaching interviews were developed in order to study how students' knowledge construction can be facilitated. In the third phase of the study I develop, evaluate and pilot test of a coherent set of learning activities that would help students develop a scientific explanation of friction at the microscopic level. In this phase I investigated how the scaffolding activities and other inputs (i.e. questions, hints, cues etc.) can be structured in order to help students construct more scientific ideas about microscopic friction. In short this phase dealt with the transition from the teaching interview protocol into a coherent activity that students can work on in small groups in a real instructional setting. I hypothesized that conceptual learning trajectories observed during the teaching interviews will be observed too as the students use the instructional module that was developed.

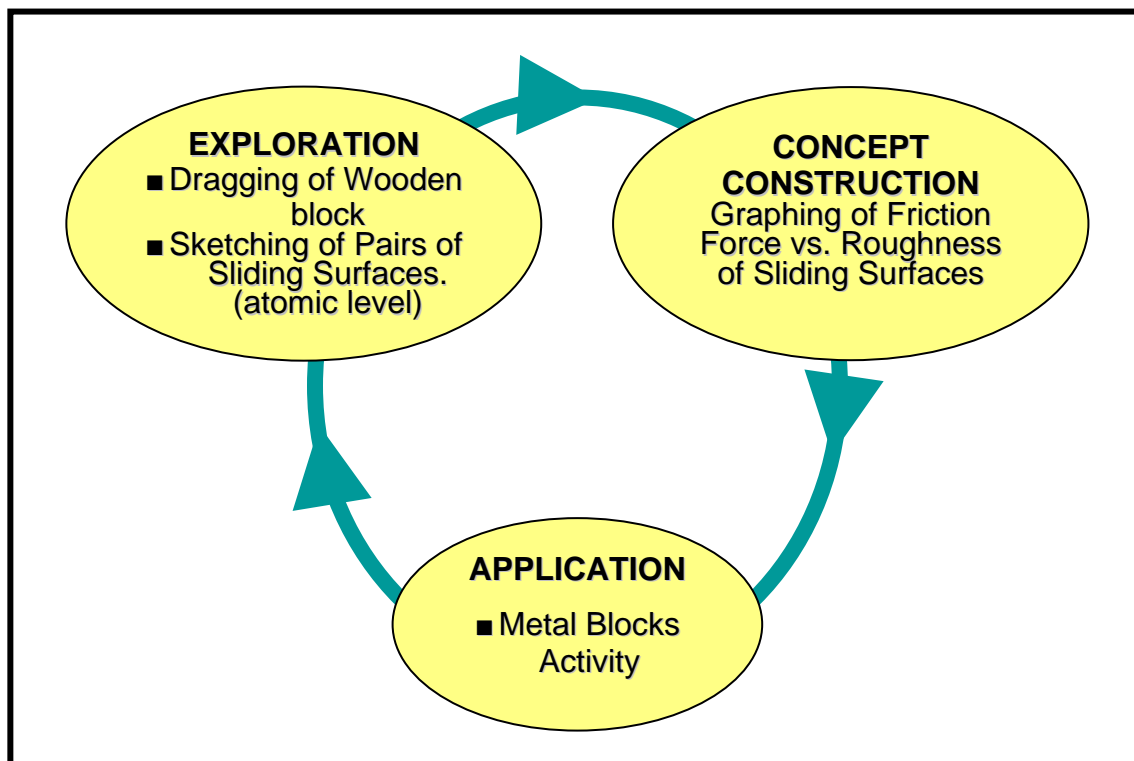
#### ***6.2.1. The Development of the Instructional Module***

The instructional module (see Appendix K - consisted of the hands-on and minds-on activities that were found to be helpful in activating appropriate associations among students

during the teaching interviews. Questions and other hints which were found helpful in making productive associations to scaffold students' knowledge construction were also included.

In terms of the sequencing of the activities, Karplus' Learning Cycle (Karplus & Renner (1974) was adopted. Students were engaged in exploration, concept construction and application activities. Figure 6.1 shows the activities that students do in the first learning cycle. The goal of the exploration is to invoke student prior knowledge about friction. The exploration activities include the dragging of wooden block across a wooden and sandpaper surface and the feeling and sketching of the different surfaces at the atom level. Here students' prior ideas about friction are activated.

**Figure 6.1. The First Cycle of the Modeling Activities**

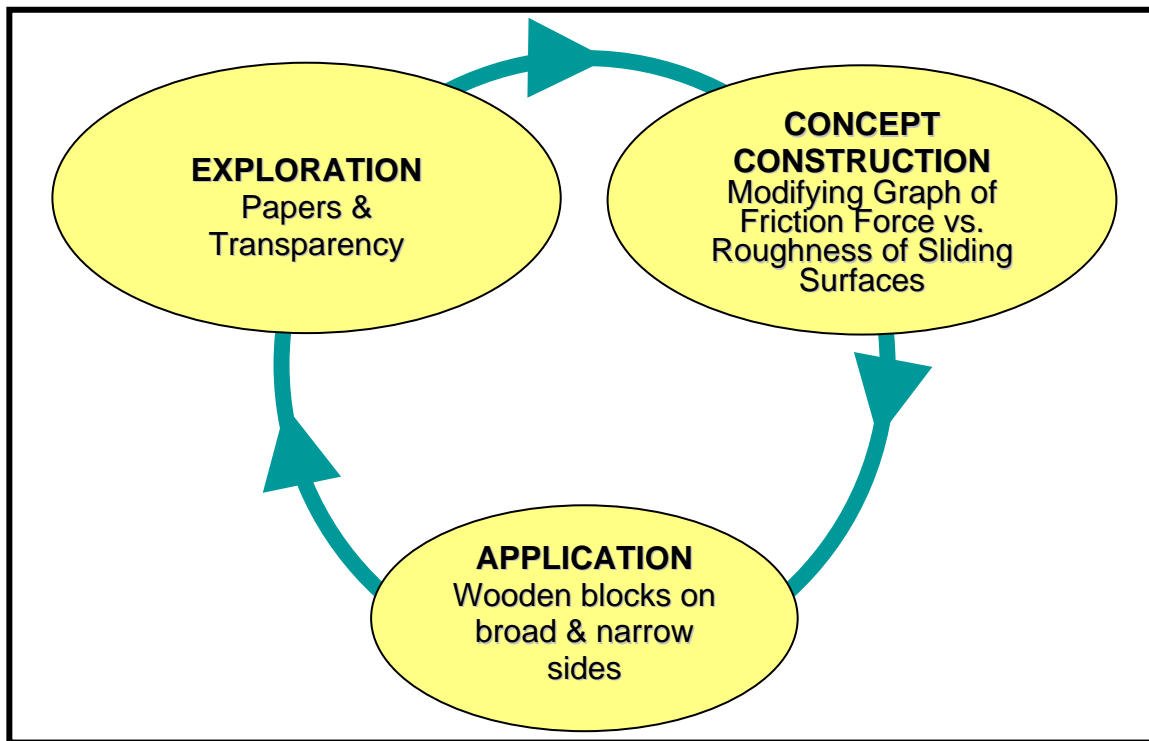


In the concept construction, students explicitly required to represent their model using multiple representations. They are asked to sketch a graph of friction vs. surface roughness and talk about what happens to the friction force in different situations.

In the application phase, students are given activities or situations where they apply the concepts that they have constructed. This particular application activity involves metal blocks with a smooth surface and other relatively rough surfaces. Here students were asked to make their predictions on which case (smooth on smooth or smooth on rough) they would observe more friction. The application activity is designed to produce cognitive conflict in that students' predictions are different from their observations.

To resolve this cognitive conflict students proceed to the second cycle of the model building process (see Figure 6-2).

**Figure 6.2. The Second Cycle of the Modeling Activities**



In the second cycle, students do the papers and transparency activity for their exploration. In this activity students take a sheet of paper and drag it across a transparency that has been rubbed with fur. They observe that the paper tends to stick to the transparency and there is resistance to the motion of the paper on the transparency. Later they take the same piece of

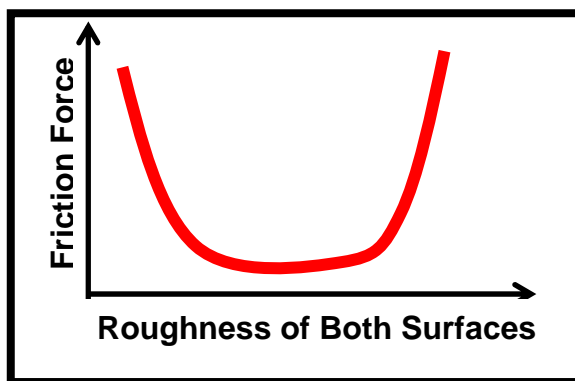


paper, crumple it, straighten it out again and drag it across the same transparency. In this case the paper does not stick and there is no resistance to the motion of the paper on the transparency.

In the concept construction phase, students are asked to explain their observations in the paper and transparency exploration activity. After they have explained their observations in terms of the ‘real’ area of contact they then revisit their previous graph and modify based on their new experiences with the paper and transparency exploration. They are also asked to reflect on their earlier experiences with the metal blocks and resolve their cognitive conflict. Thus, at the end of the concept construction phase students have a model that accounts for friction in terms of the ‘real’ area of contact between atoms. The model explains their observations with the metal blocks and the relationship between friction and surface roughness both in the microscopic as well as the macroscopic domains.

In the application phase students are asked to drag a wooden block across its wide and narrow sides. After engaging students to do the metal blocks and papers and transparency activities I envisioned that students would realize the role of the real area of contact and that friction at the atomic level varies as shown in Figure 6.3. Also, it was hoped that the students would realize the role of electrical interactions when talking about friction at the atomic level.

**Figure 6.3. Graph of Friction Force vs. Relative Roughness of Both Surfaces**



In the application activity predict the difference in friction in the two cases: block on its broad side vs. block on its narrow side. The application activity provides a context in which students apply their model that identifies the role of ‘real’ contact area in a macroscopic context. It allows them to examine how this notion of ‘real’ area of contact can yield results consistent with macroscopic result that the force of friction is independent of the area of contact, thus reinforcing the connection between microscopic processes and their macroscopic manifestations.

### ***6.2.2. Content Validation of the Instructional Module***

The first version of the instructional module was shown to two experts whose research specialization is surface phenomena. Moreover, these experts have been teaching introductory physics courses for at least six (6) semesters, so they have a sufficient knowledge about the background of intended users of the material. They examined the scientific content of the activity to ensure that the content of the module is scientifically accurate, valid and relevant. The experts' suggestions were more minimal. They were more on formatting changes such as inclusion of more pictures. The instructional material was then revised based on the experts' feedback. The revised version is in Appendix K -.

### ***6.2.3. Formative Evaluation of the Module***

Several groups of students were involved in the formative evaluation of the developed module. The students typically worked in groups of two or three students as they completed the activities. However, because it was difficult to put all students into groups due to scheduling difficulties, a few of the students completed the activity individually. The researcher observed and made field notes of each session. Each session was likewise videotaped with the IRB consent from the students. Post-activity interviews were conducted in order to cross validate the researcher's observations, get students feedback regarding students' difficulties and confusions and bring forth other issues of concern regarding the implementation of the developed instructional materials.

In addition to completing the post-activity interviews, students were also asked to complete a Likert-scale questionnaire (see Appendix L -) that pertains to the content, appeal, design, and difficulty of the developed learning instructional materials. The pilot version of the material was then revised based on the insights gained by the researcher through the observations and the feedback of students during the post-activity interview.

### ***6.2.4 Qualitative Evaluation of the Material (Formative Assessment of Learning)***


Individual as well as groups of two or three students used the developed instructional activities. I kept track of students' conceptual progression by incorporating open-ended questions in the module for them to answer. These reflective open-ended questions were embedded in the module at appropriate points so that they would provide the learner as well as the instructor-researcher feedback about student learning.

In addition to the reflective questions, stopping points were interjected into the module to encourage students to discuss their predictions, observations and thoughts with other members of the group and the instructor. Students were asked to discuss what they were doing in the activities and how these activities influenced their ideas (see Figure 6-4).


#### ***6.2.5 Development, Validity and Reliability of the Micro-Friction Test***

In addition to the qualitative assessment of student learning I also developed an instrument for quantitative assessment of student learning. To develop the test questions I first identified the learning goals of the activity -- the target ideas that I wanted students to learn. In ensuring content-related validity (Hanna, 1993 p.83) of the test, a table of specifications (see Appendix M -) was initially prepared in order to make sure that each target idea that I wanted students to learn was addressed in the test with at least one test item. The table of specifications was shown to two experts in order to cross check whether particular items measured the target ideas. Questions with corresponding distracters were then constructed. The distracters used in each of the items were based on ideas students brought out in the group and individual clinical interviews and teaching interviews conducted in the first two phases of the research. The number of items constructed was constrained by the fact that the test only intends to measure students' understanding on a single topic (microscopic friction). The initial and final versions of the test (see Appendix N -) consisted of 10 multiple-choice questions.

Figure 6.4. Keeping Track of Students' Conceptual Progression



Discuss with your group members your answers to the different questions and try to come up with a consensus answer.




Please write your consensus idea/s on the box below.

Factors Affecting Friction:

How Friction varies with Surface Roughness of Both Surfaces:

Cause of friction at the atomic level:



Write your individual thoughts now about friction?

The reliability of the test was established by computing Kuder-Richardson Coefficient using Hoyt's formula (Bruning & Kintz, 1997, p.81) as shown below:

$$r_{tt} = \frac{V_e - V_r}{V_e} \quad (6.1)$$

Where  $V_r$  = variance for remainder sum of squares

$V_e$  = variance for examinees

The post-test scores for both control and experimental were used. To establish the reliability of the micro-friction test using the above method, the computed reliability coefficient of the test was found to be 0.67, indicating that the test items were homogeneous i.e. the test

measures the same characteristic of the people taking it and reliable i.e. the individual items were producing similar patterns of responding in different people. Moreover, it is safe to say that the test is valid measure of the understanding of microscopic friction in a way that is consistent with the target ideas established for the

### 6.2.6 Quantitative Evaluation of the Instructional Material

The summative evaluation of the instructional material was conducted using two measures.. First, the relative effectiveness of the material in terms of improving students’ scores on the Micro-Friction Test was done by doing a pre-test, post-test control group design. This is discussed in more detail in the proceeding section.

Second, the status of students’ cognitive conflicts and anxiety as they went through the hands-on and minds-on activities were also monitored by having them accomplish the in-class Conflict and Anxiety Recognition Evaluation (i-CARE) developed by Kim & co-workers (2006, see Appendix O -)

#### *The Participants*

The demographics of the students who participated in the qualitative and quantitative evaluation of the instructional material is given in Table 6-1.

**Table 6-1. Phase III- Participants**

Qualitative Evaluation		Quantitative Evaluation	
<i>Physics Course</i>	<i>Number of Students</i>	<i>Physics Course</i>	<i>Number of Students</i>
1 <sup>st</sup> Semester Algebra-Based Physics	11	Conceptual-Based Physics (Experimental Group)	24
2 <sup>nd</sup> Semester Algebra-Based Physics	4	Conceptual-Based Physics (Control Group)	32
Conceptual-Based Physics	2		

### 6.3 Data Gathering Procedures

The relative effectiveness of the active-engagement learning environment using the developed material was compared with a videotaped lecture. To this end, I employed the pre-test, post-test control group design. In each group the students were given the pre-test consisting

of 10 multiple choice-type items regarding microscopic friction. The same test was administered to the students right after they finished the activities. Appendix N -shows the micro-friction multiple-choice test that was used.

In order to document students' development of ideas as they go through the scaffolding activities, a worksheet (see Appendix P -) was provided. The worksheet provides guidance to the students as they do the activities. Stopping points were explicitly provided in order to make students to reflect on what is happening. Students were also specifically required to discuss their ideas with their group members and attempted to come to a consensus idea.

## **6.4 Results**

In this section results of the qualitative and quantitative evaluation and the pilot-testing of the material as well as the formative and summative assessment of students' learning and attitudes are presented.

### ***6.4.1 Students' Attitudes towards the Developed Material***

Mean ratings by the students per item were computed. To establish the homogeneity of the ratings given, the standard deviation per item was also obtained. It can be seen in

Table 6-2 that the standard deviations of the students' ratings are all less than 1 implying the homogeneity of the ratings given per item.

Also from the same table we see that the General Physics students had very strong agreement (mean  $\geq 4.50$ ) with statements pertaining to the proper sequencing of activities, how the activities were helpful in making them build better ideas about friction at the atomic level, and how the activities challenged them to rethink more critically their prior ideas regarding friction. However, the students did not find the topic to be very interesting (mean rating of 3.82) and they do not seem to be very agreeable in incorporating the material in their *General Physics* class. However, the same sets of activities were more interesting (mean rating of 4.22) to *Concepts of Physics* students (see Table 6-3). The difference between *General Physics* and *Concepts of Physics* was statistically significant at the  $p < 0.05$  level of significance.

**Table 6-2. Students' Attitudes Toward the Developed Material (*General Physics*)**

STATEMENTS	Average Rating (n = 17)
1. The objectives of the instructional material are clear to me.	<b>4.35 ± 0.6</b>
2. I find the topic in the instructional material interesting.	<b>3.82 ± 0.8</b>
3. The level of difficulty of the material is just right for me.	<b>4.06 ± 0.6</b>
4. I find the activities interesting.	<b>4.12 ± 0.6</b>
5. The activities helped me build better ideas about friction at the atomic level.	<b>4.59 ± 0.5</b>
6. The instructions for the activities are clear.	<b>4.29 ± 0.6</b>
7. The activities challenged me to re/think critically about my prior ideas regarding friction.	<b>4.53 ± 0.5</b>
8. The activities are properly sequenced in a way that helped me progressively develop a better model about friction at the atomic level.	<b>4.59 ± 0.5</b>
9. I would like the activities to be incorporated in my <i>General Physics</i> laboratory class.	<b>3.88 ± 0.8</b>
10. I learned a lot from the activities.	<b>4.18 ± 0.6</b>
11. The instructional material helped me come up with ideas that I had never thought before.	<b>4.18±0.6</b>
12. The instructional material helped me construct my own ideas.	<b>4.18±0.5</b>
Overall Mean	<b>4.23 ± 0.7</b>

Meanwhile, in Table 6-3 we see the agreement and disagreement of the Concepts of Physics Students regarding the twelve (12) statements described above. Students have the highest degree of agreement (mean rating of 4.72) with the statement that the activities challenged them to think more critically about their prior ideas regarding friction. The other statements where students have a very high agreement (mean  $\geq 4.50$ ) for both the *General Physics* and *Concepts of Physics* students are the following:

- Activities helped build better ideas about friction
- Activities are properly sequenced in a way that helped progressively develop a better model about friction at the atomic level.
- Learned a lot from the activities
- Instructional material helped come up with ideas never thought before



**Table 6-3. Students' Attitudes Toward the Developed Material (*Concepts of Physics*)**

STATEMENTS	Average Rating (n = 32)
1. The objectives of the instructional material are clear to me.	4.22 ± 0.6
2. I find the topic in the instructional material interesting.	4.22 ± 0.6
3. The level of difficulty of the material is just right for me.	4.00 ± 0.7
4. I find the activities interesting.	4.44 ± 0.5
5. The activities helped me build better ideas about friction at the atomic level.	4.66 ± 0.6
6. The instructions for the activities are clear.	4.06 ± 0.8
7. The activities challenged me to re/think critically about my prior ideas regarding friction.	4.72 ± 0.5
8. The activities are properly sequenced in a way that helped me progressively develop a better model about friction at the atomic level.	4.66 ± 0.6
9. I would like the activities to be incorporated in my <i>Concepts of Physics</i> class.	4.16 ± 0.7
10. I learned a lot from the activities.	4.50 ± 0.6
11. The instructional material helped me come up with ideas that I had never thought before.	4.63 ± 0.6
12. The instructional material helped me construct my own ideas.	4.44 ± 0.6
Overall Mean	4.39 ± 0.6

A t-test on the mean ratings of the *General Physics* vs. the *Concepts of Physics* students groups for every statement was computed (see Appendix Q -). It was found that the *Concepts of Physics* students have a statistically higher mean rating on statements #2 ( $p \leq 0.0446$ ), #4 ( $p \leq 0.0357$ ), #10 ( $p \leq 0.0445$ ) and #11 ( $p \leq 0.0116$ ). The *Concepts of Physics* students found the topic more interesting (statement 2) and the activities also more interesting (statement 4). Moreover, the *Concepts of Physics* students had higher mean ratings in terms of the amount they learned (statement #10) and how helpful the instructional material was in helping them come up with ideas that they never had thought before (statement #11). There was no significant difference on the perceptions of the students on the other statements.

#### ***6.4.2 Students' Conceptual Progression (Formative Assessment of Students' Learning)***


Figure 6.5 shows an example of the written exercises that were embedded within the instructional materials to keep track of students' conceptual development as they went through the activities. Students would initially bring in their experiences and knowledge about macroscopic friction. For example when talking about the roughness or smoothness of sliding surfaces, students associated increasing roughness with increasing friction and increasing smoothness with decreasing friction. But as they progressed through the activities, students realized that the latter association above was not always true. They began to realize that objects could be so smooth that the atoms could interact with each other creating more friction between the surfaces. Some of them also come into realization that friction at the atomic level is not simply due to physical rubbing or interlocking of atoms but due to electrical interactions.

Table 6-4 to Table 6-14 show the different associations that students made during different stages of their model construction. As expected, when students were asked to articulate their initial ideas about friction almost all of the students gave macroscopic descriptions (see Table 6-4). There was one student though who talked about friction being associated with microscopic collisions and bonding between atoms (Association #2 in Table 6-4).

Table 6-5 shows the associations that students made when they were asked to describe what a smooth and rough surface would look like to them at the level where they see the atoms. Thirteen (13) out of seventeen (17) students made the associations that rough surfaces are associated with atoms arranged in an up and down manner and that smooth surfaces are associated with atoms lining up. Four (4) of the students made the association that rough surfaces are more spaced out and smooth surfaces are associated with atoms closer to each other. It can be noted that these variations in associations were also observed during the individual teaching interviews (see Chapter 5.5.1 Individual Teaching Interview Results & Discussions).


Figure 6.5. Keeping Track of Students' Conceptual Development

**Pre-Instruction Ideas**

 Your Ideas of friction


Friction is a factor of weight and texture as I understand it. The smoother the object the less friction it will have. Water, oil, or other liquids can reduce friction by filling in small spaces to make a surface smoother. Friction is a force.

**Post-Instruction Ideas**

 Write your individual thoughts now about friction?

I'm surprised that smooth objects are so hard to move. But thinking about it on the atomic level, it makes sense that the more surface and close proximity of the atoms creates some friction too.

**Consensus Post-Instruction Ideas**

 Please write your consensus idea/s on the box below.

Factors Affecting Friction:  
Texture, surface area, contact-bonding.

How each factor affect friction:  
Textures that are rough physically grab, textures that are smooth may bond and will have greater surface area to interact.

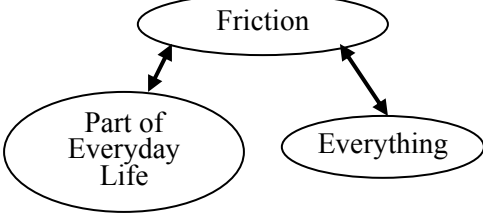
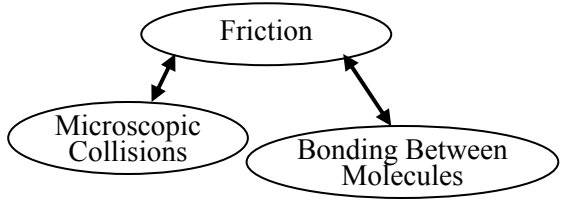
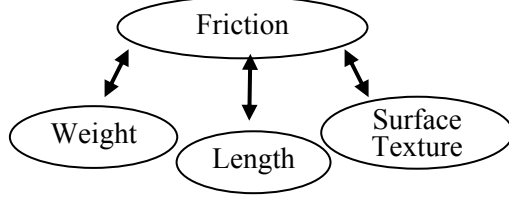
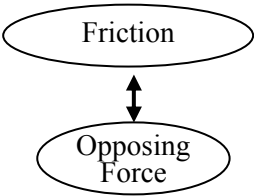
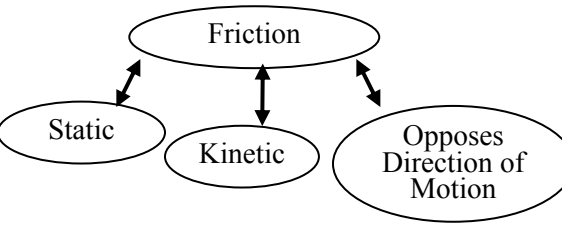
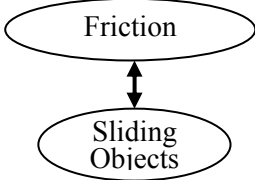
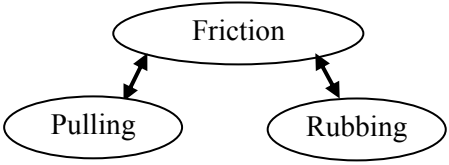
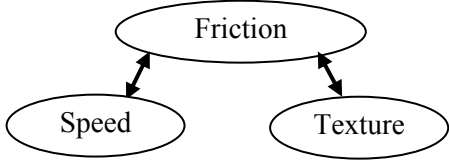
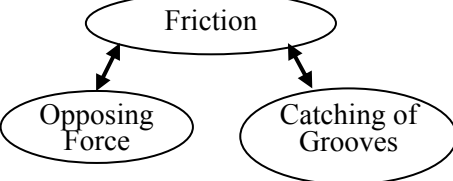
Cause of friction at the atomic level:  
Electrical Charges/ bonding of close atoms

When students were asked to make a sketch on how the friction force varies with the roughness of the sliding surfaces, 16 (out of 17) of the students maintained the association of increasing roughness with increasing friction. Out of these 16 students, fifteen (15) represented the variation of friction force versus roughness with a linear graph while one (1) of them represented the variation with a non-linear graph (see Table 6-6).

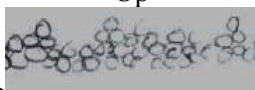
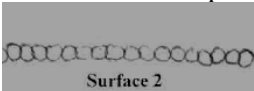


Table 6-7 shows the variations in students' associations with in explaining why the observation that it is harder to move the smooth metal block surface across another smooth metal block surface. The association of the smooth on smooth metal block surfaces with magnets is one of the most popular (6 of 17). Other variations of association include the following: there was more atom to atom contact in the smooth on smooth side (2 of 17), smooth on smooth side associated with more contact area (2 of 17), smooth on smooth are alike (2 of 17). Meanwhile, four (4) of the students were not able to come up with any explanation.

After completing the papers & transparency activity, students made the different associations as depicted in Table 6-8. It can be seen that the most popular idea (13 of 17) is the association between the real area of contact with the friction force. Meanwhile, eight (8) of the students constructed an association between the force to pull and the amount of static electricity while three (3) of them associated the force needed to pull with the cohesion of the atoms. Both of these ideas are consistent with the target ideas of the instructional unit.

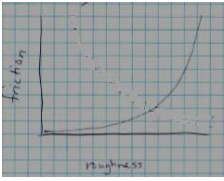
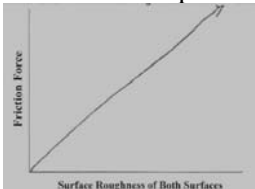
**Table 6-4: Associations made by students before doing the activities**

<i>Association #1</i>	<i>Association #2</i>	<i>Association #3</i>
 <pre> graph TD     Friction --- Part[Part of Everyday Life]     Friction --- Everything         </pre>	 <pre> graph TD     Friction --- Micro[Microscopic Collisions]     Friction --- Bonding[Bonding Between Molecules]         </pre>	 <pre> graph TD     Friction --- Weight     Friction --- Length     Friction --- Surface[Surface Texture]         </pre>
S01,	S02,	S03,S04,
<i>Association #4</i>	<i>Association #5</i>	<i>Association #6</i>
 <pre> graph TD     Friction --- Opposing[Opposing Force]         </pre>	 <pre> graph TD     Friction --- Static     Friction --- Kinetic     Friction --- Opposes[Opposes Direction of Motion]         </pre>	 <pre> graph TD     Friction --- Sliding[Sliding Objects]         </pre>
S05, S06	S07, S08	S09,
<i>Association #7</i>	<i>Association #8</i>	<i>Association #9</i>
 <pre> graph TD     Friction --- Pulling     Friction --- Rubbing         </pre>	 <pre> graph TD     Friction --- Speed     Friction --- Texture         </pre>	 <pre> graph TD     Friction --- Opposing[Opposing Force]     Friction --- Catching[Catching of Grooves]         </pre>
S10	S11	S12,

**Table 6-5: Associations made by students regarding rough and smooth surfaces**

<b>Rough &amp; Smooth Surfaces</b>	
<i>Association #1</i>	<i>Association #2</i>
<div style="display: flex; justify-content: space-around; align-items: center;"> <div style="text-align: center;"> <p>Rough Surface</p> <p>↕</p> <p>Atoms Line Up</p>  </div> <div style="text-align: center;"> <p>Smooth Surface</p> <p>↕</p> <p>Atoms Line Up</p>  </div> </div>	<div style="display: flex; justify-content: space-around; align-items: center;"> <div style="text-align: center;"> <p>Rough Surface</p> <p>↕</p> <p>Atoms are more spaced out</p>  </div> <div style="text-align: center;"> <p>Smooth Surface</p> <p>↕</p> <p>Atoms are closer together</p>  </div> </div>
S01, S02, S03, S04,S05, S07,S11,S12,S08, S13,S06,S14,S15	S10, S09, S16, S17

**Table 6-6: Associations made by students in Graphing Friction Force vs. Roughness**

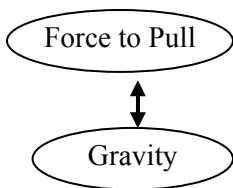
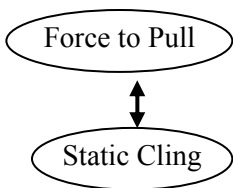
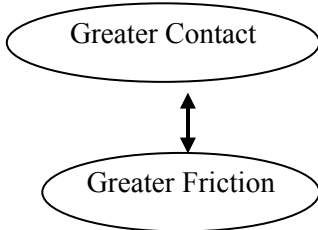
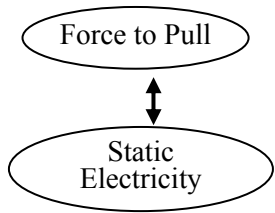
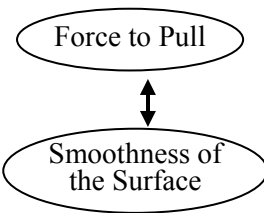
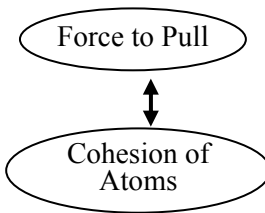
<b>Graphing of Friction Force vs. Roughness of Surfaces</b>	
<i>Association #1</i>	<i>Association #2</i>
<p>Graph of Friction Force vs. Surface Roughness</p>  <p>Increasing Roughness</p> <p>Increasing Friction</p>	<p>Graph of Friction Force vs. Surface Roughness</p>  <p>Linear Graph</p> <p>Increasing Roughness</p> <p>Increasing Friction</p>
Al Willis	S01,S02, S03,S04,S05, S07, S09, S10,S11, S12, S08, S13, S06, S14, S16,S17

**Table 6-7: Initial Explanation of Students of the Metal Blocks Activity**

<b>Metal Blocks Activity (Explanation)</b>			
<i>Association #1</i>	<i>Association #2</i>	<i>Association #3</i>	
S03, S04, S08, S14,	S11,	S01.S02, S05, S07, S09, S10,	
<i>Association #5</i>	<i>Association #6</i>		
S13,S06	S16, S17	S12	S15



**Table 6-8: Variations in the associations made by students in Activity #4 (Papers & Transparency Activity)**

<b>Papers &amp; Transparency Activity (Explanation)</b>		
<i>Association #1</i>	<i>Association #2</i>	<i>Association #3</i>
		
S01, S02	S01,S02, S10, S09, S11, S13	S01, S02, S05,S07, S09, S10, S11, S13, S06, S14, S15, S16, S17
<i>Association #4</i>	<i>Association #5</i>	<i>Association #6</i>
		
S03,S04,S05, S12, S08, S06, S16, S17	S07, S10, S09, S12, S08	S12, S09, S08

After completing the paper and transparency activities, students were again asked to explain their observation on the metal blocks. Table 6-9 shows the variations in the associations that students constructed as they tried to explain their observation. It can be seen from Table 6-9 that five (5) of the 17 students were still unable to come up with an explanation for their observation.

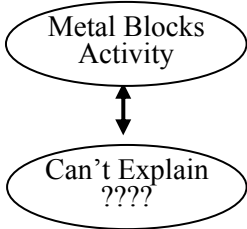
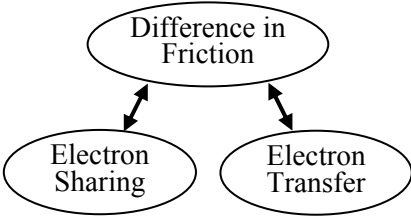
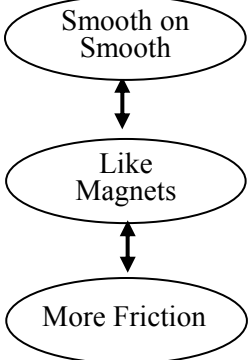
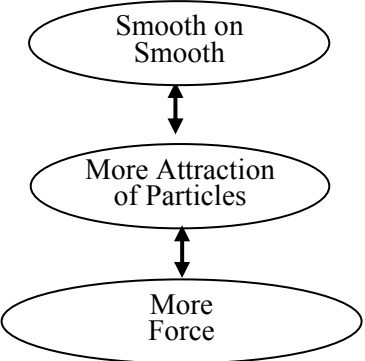
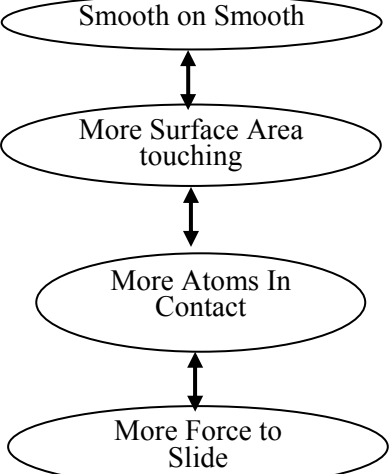
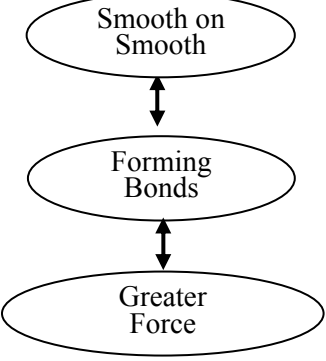
It is also interesting to examine how students' explanations changed from before they completed the paper and transparency activity. Two of the students, S09 and S10 who were now unable to explain their observations in the metal block activity had previously associated the friction between smooth on smooth metal block surfaces with a magnet. On the other hand S08 and S14 who earlier were unable to explain their observations in the metal block activity now associated the friction between the smooth on smooth metal block surfaces with bond formation and greater surface area of atoms in contact. In yet another example of change of students ideas, S16 and S17 who previously associated the friction between smooth on smooth metal block surfaces with their mutual likeness (and therefore greater force), now, after completing the paper and transparency activity, associated the friction between smooth on smooth metal block surfaces with greater surface area touching, and more atoms are in contact resulting in greater force.

After doing the papers and transparency activity the students were then asked to reflect on their previous graph of friction vs. surface roughness. A vast majority (16 out of 18) of them modified their previously drawn graph. Table 6-10 shows the variations in their their graphs and the related associations that students constructed. It can be seen that eight (8) of the students changed their graph from being linear to being a U-shaped graphed as shown in Association #1. Two (2) of the students continued to sketch a graph that was similar to the one that they had previously drawn with friction force increasing with surface roughness as shown in Association #2. Meanwhile, six (6) of the students sketched a graph of friction vs. surface roughness that sloped downward. These students associated decreasing roughness with increasing friction (Association #3). Association #3 was also observed during the individual teaching interviews. Students who made this association appeared to be transferring what they had learned in the papers and transparency activity to the metal blocks activity. These students were just considering the case where the materials are microscopically smooth. This model is equivalent to the left hand side portion of the U-shaped graph. It appears that this association between

decreasing roughness and increasing friction displaces their earlier association between increasing surface roughness and increasing friction. Thus, rather than accommodating this new association into their model of friction vs. surface roughness, these students displaced their previous association and replaced it with a new one.

It is also interesting to point out that this pattern of reasoning was not observed for any of the students in the teaching interview in Phase II. I speculate that the reason for this difference is because the teaching interview provides a context for more interaction with and feedback from the instructor. When students worked in groups, while they completed this activity, they typically did not get the same kind of scaffolding as they did from the teacher-interviewer in the teaching interview. This observation underscores the importance of the teacher in the learning process, regardless of how carefully designed the other aspects of the learning experience.

**Table 6-9: Metal Blocks Activity (Explanation 2)**

<i>Association #1</i>	<i>Association #2</i>	<i>Association #3</i>
		
S03, S04, S09, S10, S11	S02	S05
<i>Association #4</i>	<i>Association #5</i>	<i>Association #6</i>
		
S07	S12, S06 S13,S14,S15, S16, S17	S01, S08

**Table 6-10: Variations in the associations made by students in Activity # (Modifying Graph of Friction Force vs. Roughness)**

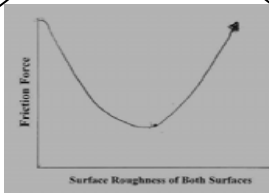
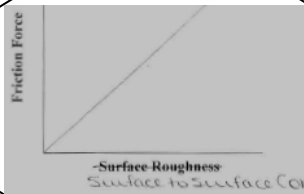
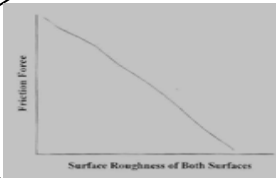
Modified Graph of Friction Force vs. Roughness of Surfaces		
Association #1	Association #2	Association #3
<p>Graph of Friction Force vs. Surface Roughness</p>  <p>Friction Force vs. Surface Roughness of Both Surfaces</p>	<p>Graph of Friction Force vs. Surface Roughness</p>  <p>Friction Force vs. Surface Roughness</p>	<p>Graph of Friction vs. Roughness</p>  <p>Friction Force vs. Surface Roughness of Both Surfaces</p> <p>Decreasing Roughness</p> <p>Increasing Friction</p>
S01, S05, S11, S12, S08, S15, S17, S16,	S13, S06	S02, S03, S04, S07, S09, S10

Table 6-11 shows the variations in their explanations of friction at the atomic level after completing the paper and transparency activity, sketching of surfaces at the atomic level and metal blocks activity. The most popular explanation (9 of 17 students) generated by the students was the association between friction and contact area and the atom to atom contact (Association # 4). The association between friction and the charges between the surfaces (Association # 3) is the next most popular (8 out of 17 students) explanation among the students.

When students were presented with the activity of dragging the wooden block on its wide and narrow sides, a majority (12 out of 17) of them predicted that there would be greater friction on the wide side because of the greater surface area of contact. These students were clearly applying the model that they had just constructed. In this model friction is associated with the contact area of atom to atom contact. Again this activity provided cognitive conflict among students in that their predictions contradict their observation. When students completed the experiment they realized that in fact the force of friction experienced by the wooden block was approximately the same whether the block was dragged on its broad or narrow sides.

To help students resolve the conflict, they were asked to do the balloon activity (see Chapter 5). Table 6-13 shows the variations in the associations made by the students after completing the balloon activity. Association #4 (same contact area means same friction) was the association that I intended students to read out from the balloon activities. However, we see that majority of the students did not read out this association. In fact, there were three students who displaced their association of friction with contact area (see Table 6-14) after doing the dragging of wooden block on its wide and narrow sides and the balloon activities

The aforementioned phenomenon was also observed during the teaching interviews. I believe that for these students, they are transferring what we call “similarities of actions”. That is, in the previous stage of the model building process they needed to displace certain associations (i.e. increasing smoothness with decreasing friction) so in this new phenomenon they see that something needs to be displaced (and they decide the association of friction with contact area). Thus for these students, the association between friction and real contact area appears to be sufficiently labile that it is easily displaced in new context.

In a way this phenomena is similar to what Greeno *et. al* (1993) would call “attunement to the affordances” of the situation. However Greeno and co-workers were referring to attunement to the physical affordances e.g. the affordance of opening a door and walking through

it, sitting in a chair or turning a crank. We are able to intuitively execute these activities because we transfer the actions that we performed in another situation that shared features with this situation. Therefore, when faced with a new situation we intuitively knew to perform the same activity.

What is going on here though is not exactly the same as ‘attunement to affordances’ in a physical sense, but rather in a metacognitive sense. Students have become so used to the notion of their ideas being contradicted by observations and then having to displace associations that they may have recently created, that when they are faced with any situation that produces cognitive dissonance they act that way almost intuitively i.e. they mentally displace their previous associations without even reconsidering them. I believe that at this juncture the instructor must intervene to ask students to reflect on their new experience and rather than displace their previous association directly urge them to reflect on it and refine their earlier raw intuition to help explain the discrepant event. Strategies to refine raw intuition, rather than discard it, are suggested by Elby and Hammer (2002), however they need a well trained instructor to help students navigate this situation appropriately.

**Table 6-11: Ideas of Friction at the Atomic Level (After Papers & Transparency and Metal Blocks Activity)**

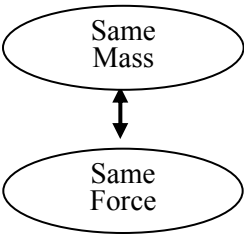
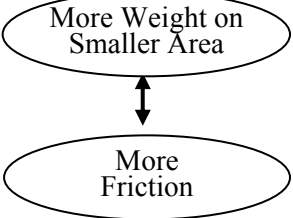
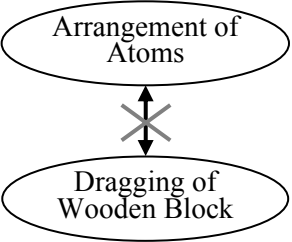
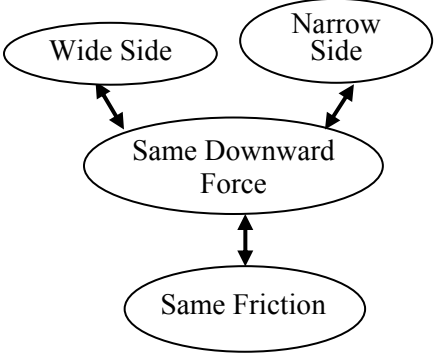
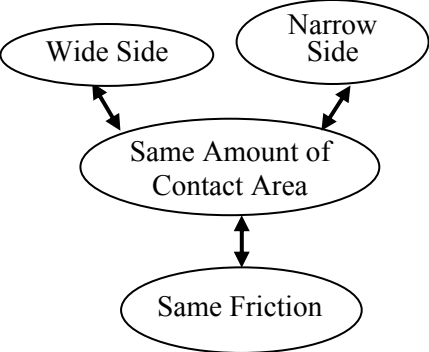
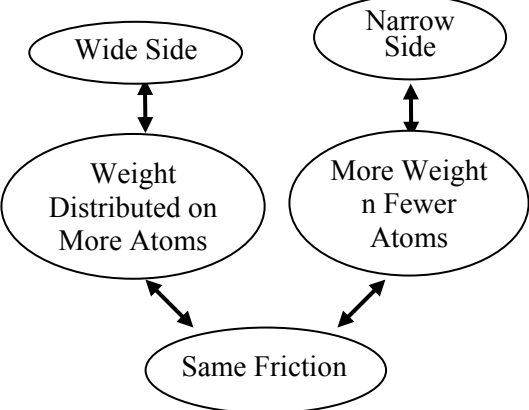
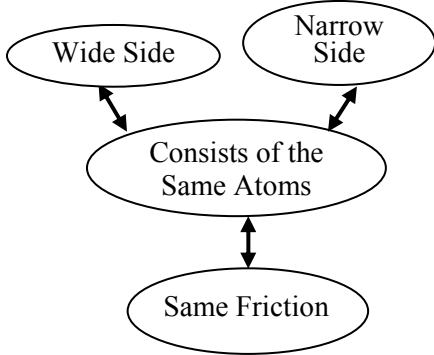
<b>Metal Blocks Activity (Explanation)</b>		
<i>Association #1</i>	<i>Association #2</i>	<i>Association #3</i>
<pre> graph TD     Friction --- Collision     Friction --- Interactions             </pre>	<pre> graph TD     Friction --- StaticForces[Static forces]     Friction --- WayAtoms[Way atoms react to each other]             </pre>	<pre> graph TD     Friction --- Charge[Charge Between Surfaces]             </pre>
S01	S02, S07	S03, S04, S05, S10, S09, S12, S17, S16
<i>Association #4</i>	<i>Association #5</i>	<i>Association #6</i>
<pre> graph TD     Friction1[Friction] --- ContactArea[Contact Area]     Friction2[Friction] --- AtomContact[Atom to Atom Contact]             </pre>	<pre> graph TD     Friction --- Proximity[Proximity of Atoms in Both Surfaces]             </pre>	<pre> graph TD     Friction --- Bonding[Bonding of Atoms]             </pre>
S05, S07, S12, S14, S15, S16, S12, S13, S06	S05	S11, S12, S08



**Table 6-12: Wood Block on its Wide and Narrow Sides (Predictions)**

<b>Predictions</b>			
<i>Association #1</i>	<i>Association #2</i>	<i>Association #3</i>	<i>Association #4</i>
S02,	S01, S03, S04, S07, S10, S09, S11, S12, S08, S15, S16, S17	S05, S14,	S13, S06

**Table 6-13: Explanation of Wood Block on its Wide and Narrow Sides Activity (After Balloon Activity)**

<i>Association #1</i>	<i>Association #2</i>	<i>Association #3</i>	<i>Association #4</i>	
				
S01, S02,	S03, S04	S10	S11	
<i>Association #5</i>		<i>Association #6</i>		<i>Association #7</i>
				
S07		S14, S15 S05, S16, S17		S09,

**Table 6-14: Ideas of Friction at the Atomic Level**

<b>Metal Blocks Activity (Explanation)</b>			
<i>Association #1</i>	<i>Association #2</i>	<i>Association #3</i>	<i>Association #4</i>
<p>Friction</p> <p><math>\mu N</math>      <math>cA</math></p>	<p>Friction</p> <p>Way atoms react to each other</p>	<p>Friction</p> <p>Surface Roughness</p>	<p>Friction</p> <p>Charges</p>
S02	S01, S07	S01, S16, S17	S05, S16, S17
<i>Association #5</i>	<i>Association #6</i>	<i>Association #7</i>	<i>Association #8</i>
<p>Friction</p> <p>Atom to Atom Contact</p>	<p>Friction</p> <p>Area of Contact</p>	<p>Friction</p> <p>Arrangement of Atoms</p>	<p>Friction</p> <p>Bonding of Atoms</p>
S01, S03, S04, S05, S14, S15, S16, S17, S11, S12	S07, S09, S10	S09, S10, S13, S06	S11, S06

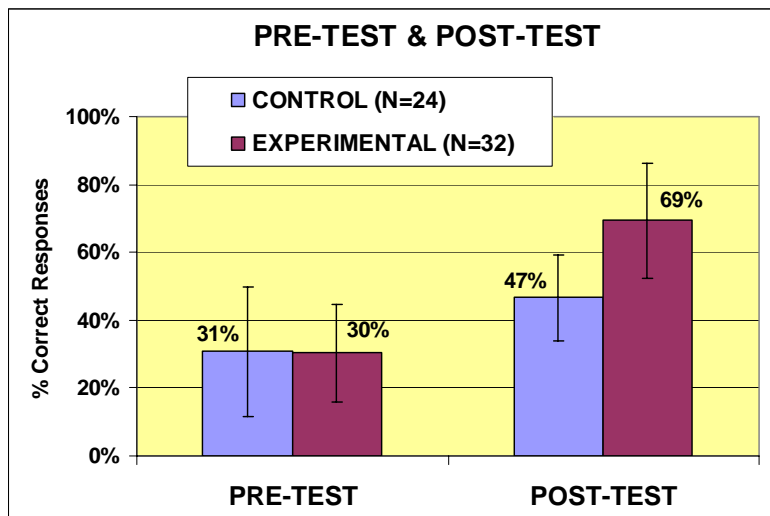
### ***6.4.3 Pilot Test of the Instructional Material***

In investigating how students who use the developed instructional material perform in traditional assessment, a pre-test post-test control group design was employed. The experimental group worked on the hands-on and minds-on activities while the control group watched a videotaped lecture on friction. The same ideas that I envisioned students to construct while they do the hands-on and minds-on activities were presented by the instructor in the videotaped lecture. The time on task between the experimental and control groups were almost equal, each being about an hour long. Moreover, the same sets of activities were performed by the instructor in the videotaped lecture. There were mainly two reasons why I used a videotaped lecture with the control group rather than a live lecture primarily for logistical reasons. First, scheduling conflicts required us to have multiple meeting times when students in the control group could view the lecture. Second, a videotaped lecture was seen as an invariant control which was not influenced by the types of interactions or questions that students might interject into a live lecture. It is important to point out that the videotaped lecture was delivered by an instructor who was teaching the class that all students were currently taking, and were therefore accustomed to his teaching style. Thus, although the lecture was videotaped it was quite as close as possible to a live lecture that these students would have received in terms of style of the lecturer.

Figure 6.6 shows a comparison between the pre-test and post-test scores of students in the experimental and control groups. A t-test for dependent sample means was conducted to determine whether there is a statistically significant difference ( $p < 0.05$ ) between the students' pre-test and post-test scores. It can be seen in Table 6-15 that the computed t value (3.427) is greater than the critical t value (2.069) at the  $p < 0.05$  level, implying that there is significant difference between the pre-test scores and post-test scores of the students in the control group.

A similar test was done with experimental group and it can be seen in Table 6-16 that the computed t value (10.93) is also substantially higher than the critical t value (2.03951) again implying a statistically significant difference ( $p < 1 \times 10^{-12}$ ) in the pre-test and post-test scores of the students in the experimental group. So, although there was a statistically significant difference between pre-test and post-test scores for both groups, the differences between these scores was far more significant for the experimental group than the control group.

**Figure 6.6. Pre-test & Post-test Scores of the Experimental & Control Groups**



**Table 6-15. T-test for the Control Groups' Pre-Test & Post-Test Scores**

<i>CONTROL GROUP</i>	<i>PRE-TEST</i>	<i>POST-TEST</i>
Mean (% Correct Response)	0.308333	0.466667
Variance	0.036449	0.02058
Observations	24	24
Pearson Correlation	0.10583	
Hypothesized Mean Difference	0	
Df	23	
t Stat	-3.42695	
P(T<=t) one-tail	0.00115	
t Critical one-tail	1.71387	
P(T<=t) two-tail	0.002303	
t Critical two-tail	2.0686548	

Comparison between the pre-test scores between the two groups was done by using t-test of independent sample means. From Table 6-17 we see that computed t value (0.1161038) is less than the critical value (2.0261905) implying no significant difference between the pre-test scores of the two groups. However, a t-test of the post-test scores of the two groups showed that there's a significant difference ( $p < 1 \times 10^{-7}$ ) between the post-test scores (see Table 6-18). The mean post-test scores (69%) of the students in the experimental group is significantly higher compared to the mean post-test scores (47%) of the control group.

**Table 6-16. T-test for the Experimental Group's Pre-Test & Post-Test Scores**

<i>EXPERIMENTAL GROUP</i>	<i>PRE</i>	<i>POST</i>
Mean (% Correct Response)	0.303125	0.69375
Variance	0.015796	0.028347
Observations	32	32
Pearson Correlation	0.07717	
Hypothesized Mean Difference	0	
Df	31	
t Stat	-10.929378	
P(T<=t) one-tail	1.8405E-12	
t Critical one-tail	1.69551868	
P(T<=t) two-tail	3.6811E-12	
t Critical two-tail	2.03951458	

The gain scores of the two groups were also established and as shown in Figure 6.7, the gain scores of the students in the experimental group are significantly higher than the gain scores of the students in the control group. A t-test of the % gain scores was conducted and the result is shown in Table 6-19. It can be gleaned from the table that the computed t value (3.9767176) is greater than the critical value (2.0128937), implying that students in the experimental group had statistically significantly higher percentage gain scores ( $p < 0.0001$ ) compared to the students in the control group.

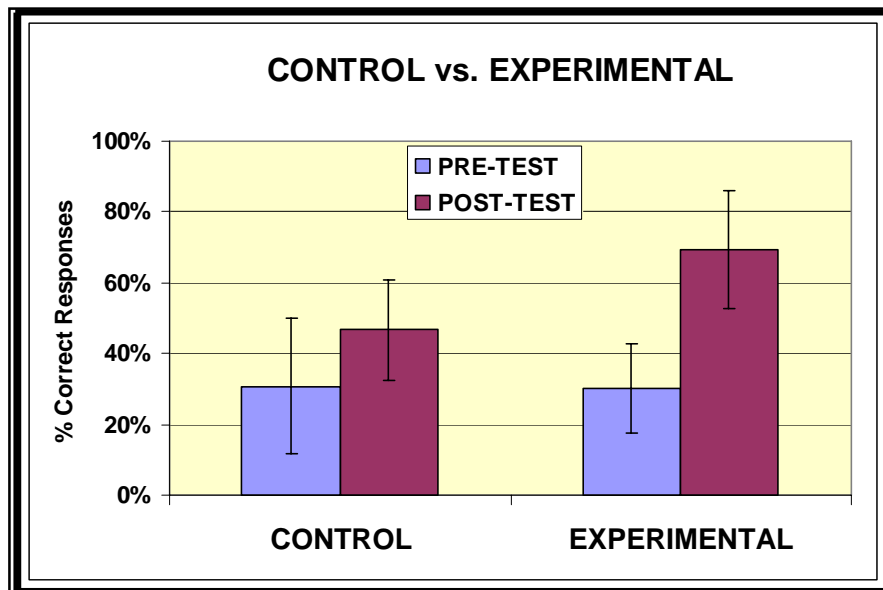
**Table 6-17. T-test of Pre-Test Mean Scores of the Control & Experimental Groups**

<i>PRE-TEST SCORES</i>	<i>CONTROL</i>	<i>EXPTL</i>
Mean	0.3083333	0.303125
Variance	0.0364493	0.015796
Observations	24	32
Hypothesized Mean Difference	0	
df	53	
t Stat	0.1161038	
P(T<=t) one-tail	0.4540991	
t Critical one-tail	1.6870945	
P(T<=t) two-tail	0.9081982	
t Critical two-tail	2.0261905	

**Table 6-18. T-test of Post-Test Means Scores of the Control & Experimental Groups**

<i>PRE-TEST SCORES</i>	<i>CONTROL</i>	<i>EXPTL</i>
Mean	0.46666667	0.69375
Variance	0.02057971	0.028347
Observations	24	32
Hypothesized Mean Difference	0	
df	53	
t Stat	-5.4387128	
P(T<=t) one-tail	6.9609E-07	
t Critical one-tail	1.67411599	
P(T<=t) two-tail	1.3922E-06	
t Critical two-tail	2.00574505	

**Figure 6.7. Pre-test vs. Post-test Comparison of the Experimental & Control Groups**



**Table 6-19. T-test of the % Gain Scores of the Control & Experimental Groups**

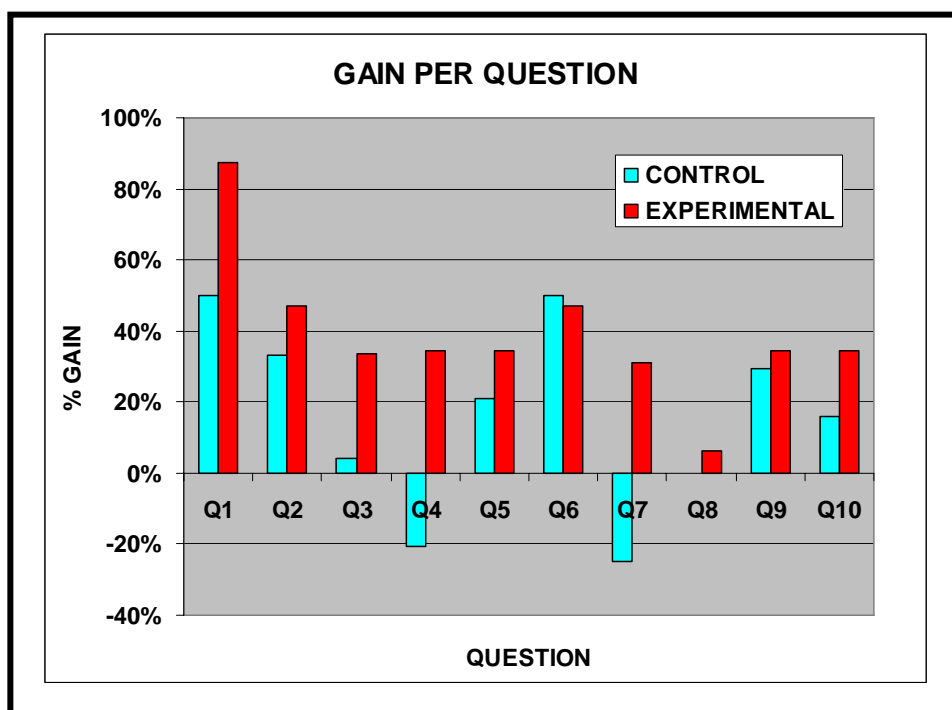
<i>% GAIN SCORES</i>	<i>CONTROL</i>	<i>EXPTL</i>
Mean	0.1583333	0.390625
Variance	0.0512319	0.040877
Observations	24	32
Hypothesized Mean Difference	0	
df	46	
t Stat	-3.9767176	
P(T<=t) one-tail	0.0001225	
t Critical one-tail	1.6786589	
P(T<=t) two-tail	0.0002451	
t Critical two-tail	2.0128937	

In terms of the gains per item in the test, the experimental group had higher than the control group in all but one of the items on the test. The experimental group showed the highest gain in item number 1 (see Figure 6.8). This item assesses the idea that when two surfaces become so smooth the friction force increases because of the increase in the number of atoms that would be electrically interacting with one another. This was one of the important target ideas of the instructional materials.

Disparities in the gain scores per question can be noted in items 3, 4 and 7. Item 3 assesses the idea that friction is not necessarily zero in a “zero g” environment due to the fact that there will still be the electrical interactions of the atoms. Item 4 assesses the idea that the leading cause of friction when there’s flat layer of atoms. Meanwhile, item 7 assesses the idea that at the atomic level the friction force varies inversely with the microscopic roughness (which in this study is measured in terms of the alignment of surface atoms).

It can also be noted in Figure 6.8 that the control group had negative gains in items 4 and 7. This implies that simply telling students that friction is caused by electrical interactions is not sufficient and effective in changing their ideas.

**Figure 6.8. Gain Scores per Question in the Two Groups**





The students who used the hands-on and minds-on activities (experimental group) tended to have better incorporated into their schema the role of electrical interactions in friction at the atomic level.

The gain scores of the two groups in item 6 and item 9 were not statistically different. These items gauged their ideas on comparing friction between smooth and rough surfaces based on sketches at the atomic level. The result implies that in terms of this construct, students from both groups seemed to provide the same responses.

Overall, the statistical analysis of data from the pilot-test conducted clearly showed that the students who used the developed instructional material performed significantly better in the traditional test (Micro-Friction Test) than those who watched the videotaped lecture.

### *Students' Cognitive Conflicts and Anxiety*

The status of students' cognitive conflicts and anxiety as they went through the hands-on and minds-on activities were monitored by having them complete the 'In-class Conflict and Anxiety Recognition Evaluation' (I-CARE) developed by Kim & co-workers (2006)

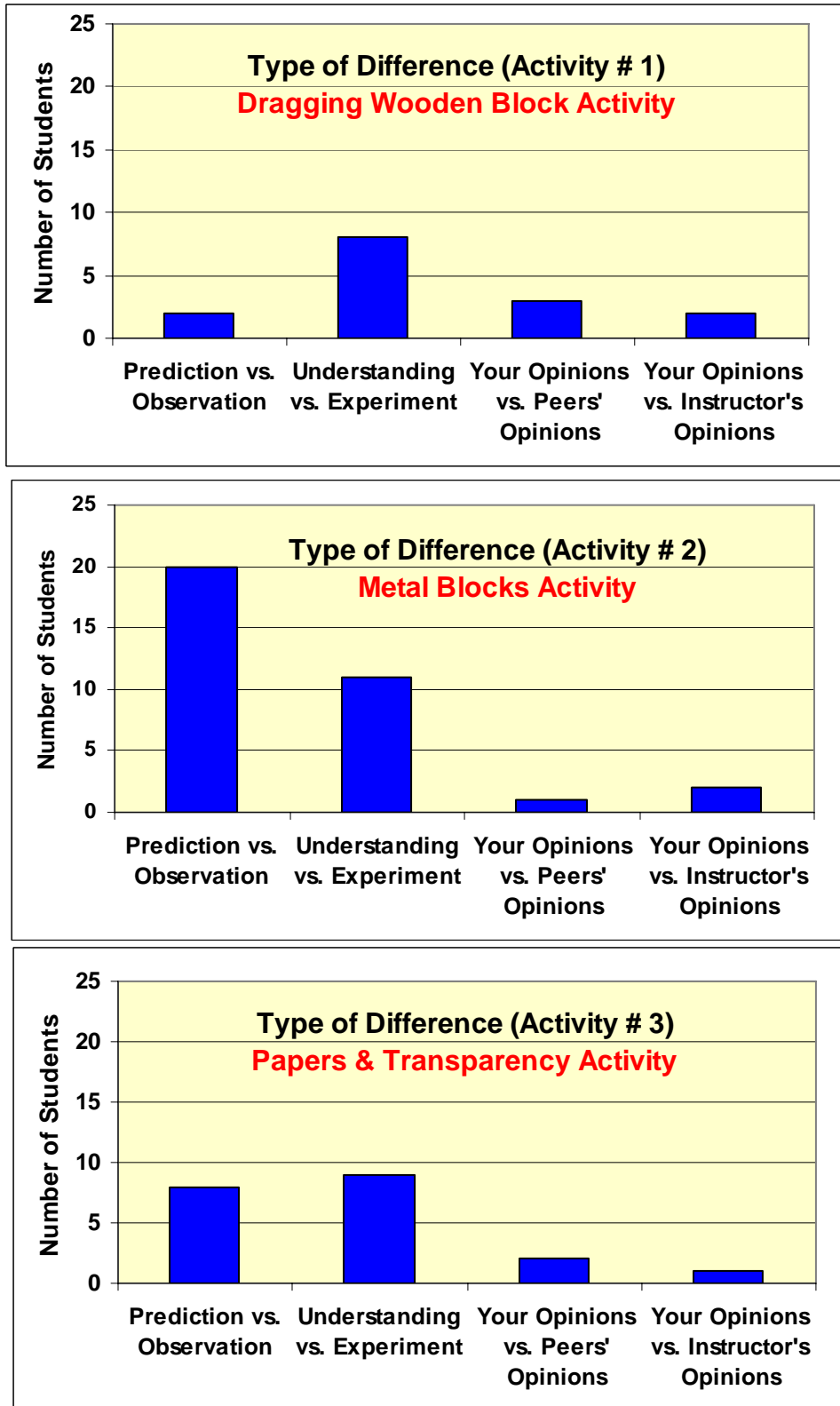
First the students were asked to choose activities which they believed had caused the following kinds of differences:

1. differences between their predictions and observations,
2. differences between their understanding and understanding of another experiment,
3. differences between their opinions and the opinions of other group members, and
4. differences between their opinion and the opinions of the instructor.

They were further asked their attitudes towards those differences. Figure 6.9 shows the different activities selected by the 24 students, the identified differences caused by the activity and how they were affected by these differences. It can be seen that eight students (8) indicated that Activity #1 (Dragging of Wooden Block) caused a difference between their understanding of one experiment and their understanding of another experiment. As expected, majority (20 out of 24) indicated that Activity #2 (Metal Blocks Activity) caused differences between their predictions and the results of the experiment. Ten (10) of the students indicated that Activity #2 caused a difference between their understanding of one experiment and their understanding of another experiment. I speculate that they were referring to the differences between the wooden

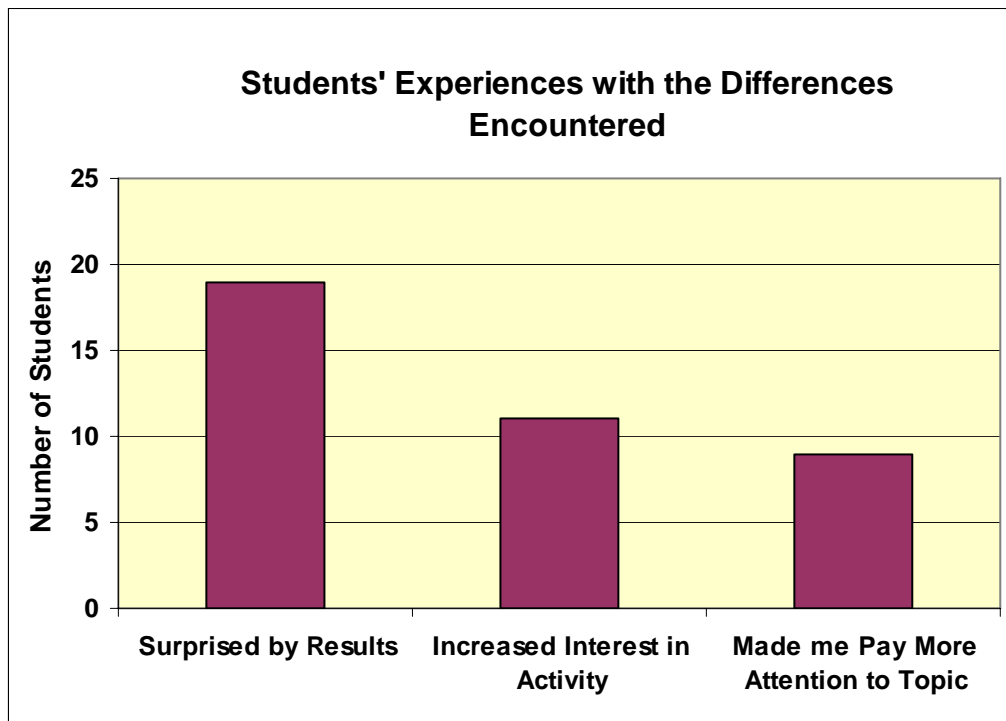
block activity and the metal block activity (i.e. Activity # 1 and # 2). Nine (9) of the students indicated that Activity #3 (Papers & Transparency) caused a difference between their understanding of one experiment and their understanding of another experiment. These results clearly demonstrate that the activities indeed provided cognitive conflict among students.

Figure 6.9. Differences Caused by the Activities



But how were the students affected by these differences? Figure 6.10 shows the effect of the difference identified above for each of the activities. It can be seen that most of the students (19) were surprised by the results of the activity. Eleven (11) of them indicated that the differences between their predictions and observations increased their interest in the topic. Meanwhile, nine (9) of them indicated that the differences made them pay more attention to the topic and spend more time to work on it.

**Figure 6.10. Students' Experiences with the Differences Encountered**



Thus, it appears that the cognitive conflict produced in these activities did not produce any deleterious effects on their disposition toward learning. In fact, the results appear to indicate that for many of the students, the cognitive conflict produced by the activities had a positive impact on their attitudes toward learning. I speculate that the cognitive conflict in the activities did not appear to cause undue anxiety among students, as some curriculum designers are concerned, because students were provided activities that help them resolve the conflict soon after the discrepant event.

## 6.5 Chapter Summary

This chapter presents the methodology, data analysis technique, and results of the third phase of the research which involved the development, formative evaluation and pilot-testing of the instructional activities on microscopic friction. Action research methodology was adopted in order to address the research question for the third phase of the research.

The instructional activities were a by-product of the teaching experiment that was conducted in the previous phase of the research. The activities, questions and hints which were found productive in helping students progress to a certain conceptual trajectory were incorporated. The developed instruction material was then shown to experts for content validation.

Formative evaluation of the instructional material was conducted by having intended users go through the sequence of the activities. The students typically worked in groups of two or three students as they completed the activities. The researcher observed and made field notes of each session and also conducted post-activity interviews in order to cross validate the researcher's observations, get students feedback regarding students' difficulties and confusions and bring forth other issues of concern regarding the implementation of the developed instructional materials. Moreover, a Likert-scale questionnaire that pertains to the content, appeal, design, and difficulty of the developed learning instructional materials was accomplished by individual students. A multiple choice test (Micro-Friction Test) was developed in order to quantitatively gauge students' understanding of microscopic friction. The validity and reliability of the test were established.

The summative evaluation of the instructional material was conducted using two measures. First, the relative effectiveness of the material in terms of improving students' scores on the Micro-Friction Test was determined by conducting a pre-test, post-test control group design. Second, the status of students' cognitive conflicts and anxiety as they went through the hands-on and minds-on activities were also monitored by having them accomplish the 'in-class Conflict and Anxiety Recognition Evaluation' (i-CARE) developed by Kim & co-workers (2006)

In terms of students' attitudes towards the developed instructional material, students gave a favorable rating on content, appeal, design, and difficulty. The average rating given by the seventeen (17) *General Physics* students was 4.23, indicating a very favorable perception.

Meanwhile, the thirty two (32) *Concepts of Physics* students also rated the material favorably with an overall mean rating of 4.39.

Students' conceptual trajectories were also established while they use the developed instructional material. Result show that a lot of the associations that students generated as they used the instructional material were quite similar to the ones observed during the teaching interviews. However, differences on their use of the associations were noted. For example, I observed that in the teaching interview students were able to incorporate the association of increasing smoothness with increasing friction to their previous association of increasing roughness and increasing friction. In the case of the students who used the instructional material, it appeared that the association between increasing smoothness and increasing friction displaces their earlier association between increasing surface roughness and increasing friction. Thus, rather than accommodating this new association into their model of friction vs. surface roughness, these students displaced their previous association and replaced it with a new one.

It is also interesting to point out that this pattern of reasoning was not observed for any of the students in the teaching interview in Phase II. I speculate that the reason for this difference is because the teaching interview provides a context for more interaction with and feedback from the instructor. When students worked in groups, while they completed this activity, they typically did not get the same kind of scaffolding as they did from the teacher-interviewer in the teaching interview. This observation underscores the importance of the teacher in the learning process, regardless of how carefully designed the other aspects of the learning experience.

Results also show that students who used the instructional material performed significantly better compared to students who used a videotaped lecture on microscopic friction.

It was also established that the activities indeed provided cognitive conflict among students. However, it appears that the cognitive conflict produced in these activities did not produce any deleterious effects on their disposition toward learning. In fact, the results appear to indicate that for many of the students, the cognitive conflict produced by the activities had a positive impact on their attitudes toward learning. I speculate that the cognitive conflict in the activities did not appear to cause undue anxiety among students, as some curriculum designers are concerned, because students were provided activities that help them resolve the conflict soon after the discrepant event.

## **CHAPTER 7 - Summary and Conclusions**

### **7.1 Overview of the Study**

At present we are at the verge of several breakthroughs in nanoscience and technology. There is an urgent need to make the citizenry scientifically literate about these scientific and technological developments. To this end, there have been several efforts to develop curricular materials geared toward advancing nanoscience education in the elementary, secondary and undergraduate levels. However, for these efforts to succeed there is a dire need for research studies that would inform curriculum developers the details on how students learn and build their understanding of phenomena at the nanoscale.

This study investigated students' modeling of friction at the microscopic level. Friction is a familiar concept that is a part of the daily life of students and a concept that they might have had previously studied in their science courses. While friction is a well known phenomenon at the macroscopic level, it is very poorly understood at the microscopic level, not just by students, but also by scientists. Nanotribologists are currently providing evidence of disparity between microscopic and macroscopic friction. The disparity provides a useful context for exploring students' ideas and the cognitive process underlying knowledge construction. These processes are the focus of this research. Learning about microscopic friction will help students understand some of the key scientific issues underlying the promise of nanoscience and technology.

A vast majority of studies in physics education (McDermott & Redish, 1999) about students' learning and understanding are focused on students' misconceptions and difficulties in various topics. There have been relatively few research studies that investigate students' knowledge construction, which is the main focus of this research. Fewer still are studies that investigate how students construct or reconstruct their knowledge about a phenomenon at the microscopic world (Unal, 1996; Hamed, 1999). This research will add to the body of literature in that area of need.

This research was conducted at the main campus of Kansas State University (KSU), Manhattan, KS. The participants of the study were taking one of the following introductory

physics courses: The Physical World -- conceptually-based for non-science majors, Concepts of Physics – conceptually-based for elementary education majors, General Physics – algebra-based for life-science majors, Engineering Physics – calculus-based for engineering and physics majors.

In the first phase of the study, I investigated students' existing mental models of atomic friction by conducting clinical interviews with eleven (11) Contemporary Physics students. The variations in their models were established through phenomenographic (Marton, 1986) analysis of clinical interview data.

Furthermore, I also interviewed content experts and conducted a thorough survey of literature to understand the models that scientists typically use to explain microscopic friction. Keeping in view students' naïve models and those used by experts, I arrived at a set of target ideas or models that I concluded were appropriate goals for student learning. These target ideas, after validation by a set of educational and content experts, were used in carrying out the second phase of the research.

The second phase of the research focused on creation of learning experiences that provide a context for investigating the dynamics of students' model construction and reconstruction. I conducted individual and group teaching interviews to determine students' learning trajectories and the dynamics of students' model construction and reconstruction processes as they created a new model of friction at the atomic level while progressing through these learning experiences. The teaching interviews specifically made me aware how the scaffolding activities influence students' model construction and reconstruction and hence allowed me to investigate the conceptual development of students as they go through the scaffolding activities. Furthermore, the group teaching interviews provided me insights into the variations of the dynamics of students' interaction as they completed a series of model-building activities.

The third phase of the research involved the development and validation of an instructional module and associated assessment tasks, based on my insights into students' learning trajectories. The module was geared towards helping students construct with a scientific model of atomic friction. Scaffoldings, based on results of the second phase which were found productive in helping students reconstruct their knowledge were incorporated in the development of the instructional material. Student-material, student-student, and student-instructor interactions were investigated by having several groups of students using the instructional



module in a laboratory-like setting. Content validity of the instructional module and assessment tasks was established by having content-experts critique the developed material.

## 7.2 Conclusions

In this section I address the different research questions that were formulated at the beginning of this research study.

### ***7.2.1 Research Question #1: What are the variations in the existing models of introductory college physics students regarding microscopic friction?***

Based on the analysis of data from the clinical interviews conducted with eleven (11) introductory college physics students three (3) variations were noted in students' models in explaining friction at the atomic level: interlocking/intertwining model, rubbing/sliding of atoms, breaking of bonds model. In the "interlocking model", friction is the force needed to pull an atom over the bumps due to mechanical intertwining or interlocking of atoms. In the rubbing/sliding model, friction is produced by the rubbing or sliding of an atom past another atom. Lastly, in the "breaking of bonds" model, friction is the force needed to break the bonds between atoms of surfaces that come into contact. A vast majority (10/11) of the students used the interlocking/intertwining and the rubbing/hitting of atoms model in their explanations.

The above findings suggest two themes in students' explanations of friction at the atomic level. Most of the students hold onto the idea that friction at the atomic level is simply due to *mechanical interactions*. This finding is evident from the models used by students in explaining why static friction is greater than kinetic friction as well as the lubricating mechanism of oil. When students were asked to sketch what the smoothest surface would look like at the atomic level, they often drew atoms lining up. When asked if there was still friction when two such surfaces come into contact and move past one another, I often heard students say, "*There will still be friction because there is still some contour in them (atoms.)*" Thus, for most students, what is true macroscopically must also be true microscopically.

The second theme is the *breaking of bonds* explanation. According to three (3) of the (11) students interviewed, microscopic friction is the force needed to break the bonds between the atoms of surfaces that come into contact. When these students were asked to explain why kinetic friction is less than static friction they explain that there are fewer bonds to break once the other surface is set in motion.

### ***7.2.2 Research Question #2: What scaffolding (cues, hints, activities and other external inputs) causes students to reorganize their knowledge about atomic friction?***

Based on the data gathered from the 18 teaching interviews I was able to document how a particular scaffolding activity impacts students' knowledge construction. In terms of making sketches of rough and smooth surfaces, three variations in students' associations were noted. Two students associate smooth surfaces with atoms closer together while one of them appeared to think otherwise. A vast majority of the students (16/18) interviewed associated a rough surface with atoms arranged in an up and down jagged arrangement, while a smooth surface is associated with atoms lining up. Clearly, we see that students are building on their macroscopic ideas. These associations were particularly helpful in facilitating students' associations between the friction force and the real (atom to atom) contact. For some students merely sketching the surfaces activated their prior knowledge about charges.

The activities of the dragging of a wooden block across the wooden plank and sandpaper surface and the graphing of friction force versus the roughness of the surfaces tend to effectively elicit students' prior ideas about friction. These activities elicit the association between increasing roughness and increasing friction.

Meanwhile, the metal blocks activity was particularly useful in challenging students to rethink their prior ideas about friction. For some students this activity activates their internal resources about electrical bonding and subsequently helped these students make the association between the friction force on very smooth surfaces with the bonding of atoms. For most students, this is not the case. They needed further scaffolding in order to make sense of their observations. Having students sketch the pair of sliding surfaces activates the association between the friction force and the contact area, an association which is further strengthened when they do the paper and transparency activity.

Furthermore, by having students do the paper and transparency activity, their internal resources about charges are also being activated which makes them make the association that when surfaces become microscopically smooth the charges come into play. The quality of their explanations obviously depended upon the span of their knowledge about charges and their interactions. When students were asked to modify their previous graph of friction force versus roughness of the surfaces, they tried to assimilate into their previous model the association of increasing friction with increasing smoothness to come up with the u-shaped graph.

It has been established in this research that for a certain target idea (U-shaped graph of friction vs. surface roughness), students tend to have the same trajectory when they are provided with the same sets of scaffolding activities. In coming up with the U-shaped graph, students needed to assimilate the association of increasing friction with increasing smoothness into their existing association of increasing friction with increasing roughness. However, for some target ideas, such as the role of electrical interactions in friction, the students seem to need different scaffolding inputs. The reason is that in this case students need to modify their knowledge structure by breaking existing associations of friction at the atomic level with mechanical interactions. Some students require more scaffolding to help them suppress this association and activate the association of atomic friction with electrical interactions. In other words students needed to accommodate electrical interactions into their model. This finding appears to indicate that students would be more willing to undergo conceptual change if it involves assimilation of certain concepts into their existing knowledge structures, rather than a situation where they need to modify their internal knowledge structures.

### ***7.2.3 Research Question #3: To what extent can students utilize this scaffolding to reorganize and reconstruct their models of atomic friction?***

The extent to which students make use of the inputs provided to them to construct a target model greatly depends on their zone of proximal development. It is apparent from the results of our analysis that those students with broader span of knowledge about charges and their interactions tended to create more scientific explanations about the phenomena observed. In other words a broader span of knowledge of charges and interactions corresponded to a wider zone of proximal development because it afforded these students the cognitive resources with which they could construct their new model. Thus, how far we can facilitate their model building process greatly depends on their internal knowledge which in turn is related to their zone of proximal development. Also, the scaffolding activities appeared to facilitate efficient control of displacement and incorporation of associations to explain their observations and construct a new model of microscopic friction.

#### ***7.2.4 Research Question #4: What are the variations in students' interactions as they go through a series of model-building activities?***

From the analysis of the data gathered from the group teaching interviews, four variations in students' interactions were noted:

Student interaction could be balanced or unbalanced. For balanced interaction every participant tended to participate in the discussion as they went through the model-building activities. There were three variations observed. The first type of interaction is the case where all students tended to be assimilating their peers ideas into their own in coming up with their models. The second variation (one-way assimilation) is the case where one of the students simply stuck to his ideas and was not affected in anyway by the ideas presented by peer. Students tried to assimilate the ideas brought out by each other. Another mode of interaction that was observed was the case where two students started out with different models of explanation and then tried to accommodate each other's model as the teaching interview progressed. However, ultimately, these two students converged in their models of explanation by assimilating the associations picked up from their peer with their own initial internal associations.

The “*pitcher and catcher*” mode of interaction results in an unbalanced participation. This case was observed for two students who apparently were in different zones of proximal development. This type of interaction would likely happen if one of the members has broader span of knowledge and has accumulated more internal resources than the other group member. In this situation, the other student is somewhat shut off from collaborating in the model-building process and tends to remain more passive, while the first student is more active.

#### ***7.2.5. Research Question #5: What teaching interventions and/or instructional strategies can be designed to help students come up with a more scientifically accepted model of atomic friction?***

Through sequences of hands-on and minds-on activities, including cognitive dissonance and resolution, it is possible to facilitate students' construction of a scientifically correct model of atomic friction. Moreover, the extent to which students can utilize this scaffolding to construct the target ideas depends upon their individual zone of proximal development. Students who have knowledge of electrical interactions can build on their models through the sequences of activities developed. However, for students who are unfamiliar with electrical interactions,

some of the target ideas appeared to fall outside their zone of proximal development. For instance, these students were able to construct the U-shaped graph describing force of friction vs. surface roughness as well as the relationship with the area of contact. But they were unable to accommodate the role of electrical interactions into their model of microscopic friction.

The sets of activities appeared to produce the desired cognitive conflict for most of the students. However, this cognitive conflict did not appear to produce any deleterious effects in their disposition toward learning. In fact, the results appear to indicate that for many of the students, the cognitive conflict produced by the activities had a positive impact on their attitudes toward learning. I speculate that the cognitive conflict in the activities did not appear to cause undue anxiety among students, as some curriculum designers are concerned, because students were provided activities that help them resolve the conflict soon after the discrepant event.

## **7.3 Implications for Research, Curriculum Development & Instruction**

### ***7.3.1 Further Research***

This study has identified several issues that can affect students' modeling of phenomena at the microscopic level. However, several issues emerged which could be addressed in future research.

I found that one of the variations in the dynamics of interactions between students is the case where one of the students seems to dominate the discussion because their zones of proximal developments do not overlap. Further investigations could be conducted to determine how one can better optimize collaboration during model-building process in this type of situation.

In this study I primarily used hands-on activities in order to scaffold students' learning. I have not examined how simulations might impact students' model construction and reconstruction. Further research can be conducted to investigate students' conceptual projections when they are provided scaffolding using computer simulations.

In scaffolding students' modeling of friction at the atomic level, I particularly adopted the hard sphere model of the atom. Further research can be done to investigate the extent to which they can use other models of the atom and subsequently investigate how their explanations of atomic friction would be affected. This research might be particularly useful to conduct with students who already have some knowledge of the quantum mechanical nature of the atom --- such as students in their third semester of a physics course or physics and chemistry majors.

### ***7.3.2 Instruction***

I have demonstrated in this research study that with respect to a certain target idea, a set of scaffolding activities may produce the similar conceptual trajectories among different students. For example for in coming up with the U-shaped graph of friction force versus surface roughness, the wooden block, metal blocks, and papers & transparency activities seem to provide similar conceptual trajectories among students. However, in understanding the role of electrical interactions the students seem to need different scaffolding inputs depending on their span of knowledge of electrical interactions.

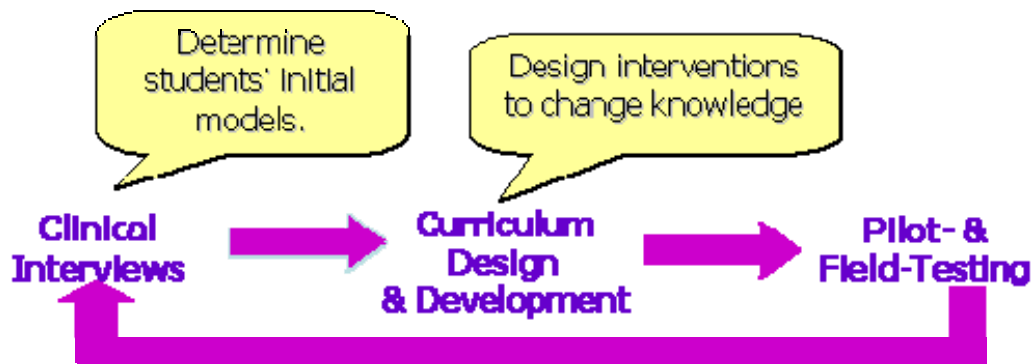
Throughout the instructional module I observed that even though students were able to construct the target ideas by themselves by performing the activity, answering the questions and interacting with their peers, most felt the need for an authority figure that would facilitate their learning. An instructor is critical for providing formative feedback to students and also providing appropriate scaffolding to facilitate the activation of productive associations between phenomena they are interacting with and their own internal knowledge. This implies that we should not attempt to design stand alone curriculum material, without taking into consideration the role of the instructor.

The importance of the role of the instructor discussed above also underscores the point that we must focus our efforts on synergistic models of research, instruction and curriculum development in which students, teachers and researchers all of whom are stakeholders in the educational enterprise work collaboratively to develop superior models of learning.

### ***7.3.3. Curriculum Development***

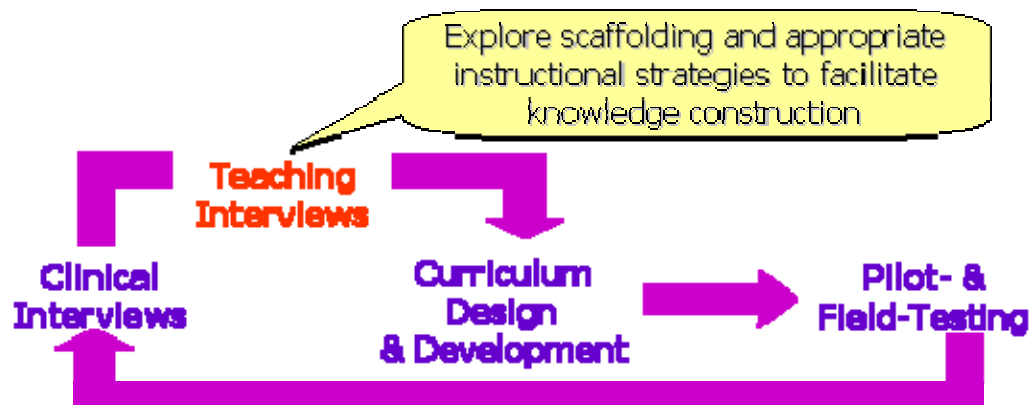
It has been observed that the teaching interview can play a very significant role in optimizing the benefits of curriculum materials. Typically, the curriculum development process follows the steps indicated in Figure 7.1. First, one conducts clinical interviews with students to determine students' initial models. Based on students' initial knowledge, one designs interventions to facilitate conceptual change. The developed materials are then pilot-tested and field-tested. Formative evaluation of the material is done by conducting clinical interviews with experts & target users.

**Figure 7.1. Typical Curriculum Material Development**



I believe that research completed in this study has demonstrated the process can be significantly improved by conducting teaching interviews (see Figure 7.2.) in transitioning from the establishments of students' initial knowledge via clinical interviews to the design and development of interventions.

**Figure 7.2. Alternative Strategy for Curriculum Design and Development**



The teaching interview can elucidate the fine-grained detail of students' knowledge construction processes. This will subsequently allow one to establish appropriate scaffolding activities that can be afforded to students to lead them to a particular conceptual trajectory.

Thus, this research study has broader implications for curriculum development that extend beyond the scope of the content addressed in this study. The curriculum design and development strategy suggested below is particularly useful in content areas where students may not necessarily have well established models. In these cases, it is even more important and productive to focus on how they construct their ideas rather than on their initial understandings.



## Bibliography

- Abraham, M. R., E. B. Grzybowski, et al. (1992). "Understanding and misunderstandings of eighth graders of five chemistry concepts found in textbooks." Journal of Research in Science Teaching **29**: 105-120.
- Adams, L., J. Kasserian, et al. (1988). "The effects of facts versus problem-oriented acquisition." Memory and Cognition **16**: 167-175.
- Anderson, B. R. (1990). Pupils' conception of matter and its transformations (age 12-16). Relating macroscopic phenomena to microscopic particles: A central problem in secondary science education. P. L. Lijnse, Licht, P., Vos, W., de Waarol, A. J., Utrecht, CD-B Press. **12-35**.
- Andersson, B. R. (1990). Pupils' Conceptions of matter and its transformations. In Relating macroscopic phenomena to microscopic particles: a central problem in secondary. P. L. P. L. Lijnse, W. Vos. Utrecht, Germany, CD-β Press: 12-35.
- Bao, L. and E. F. Redish (2000). "Model Analysis: Modeling and Assessing the Dynamics of Student Learning." Journal of Physics Education Research submitted.
- Barlia, L. and M. E. Beeth (1999). High School Students' Motivation to Engage in Conceptual Change Learning in Science. Annual Meeting of the National Association for Research in Science Teaching, Boston, MA, National Association for Research in Science Teaching.
- Bartlett, F. C. (1932). Remembering. Cambridge, Cambridge University Press.
- Bassok, M. (1990). "Transfer of domain-specific problem-solving procedures." Journal of Experimental Psychology: Learning: 522-533.
- Bodner, G. (1986). "Constructivism: A theory of knowledge." Journal of Chemical Education **63**(10): 873-878.
- Bonk, C. J. and D. J. Cunningham (1998). Searching for learner-centered constructivist and sociocultural components of collaborative educational learning tools. Electronic Collaborators: Learner-centered technologies for literacy, apprenticeship, and discourse. C. J. Bonk and K. S. King. Mahwah, NJ, Lawrence Erlbaum Associates.
- Bowden, F. P. and D. Tabor (1950). Friction and Lubrication of Solids, Oxford University Press.
- Bransford, J. D., A. L. Brown, et al., Eds. (1999). How People Learn: Brain, Mind, Experience, and School. Washington, DC, National Academy Press.
- Bransford, J. D., J. J. Franks, et al. (1989). New approaches to instruction: Because wisdom can't be told. Similarity and Analogical Reasoning. S. Vosniadou and A. Ortony. Cambridge, U.K., Cambridge University Press.
- Bransford, J. D. and D. Schwartz (1999). "Rethinking transfer: A simple proposal with multiple implications." Review of Research in Education **24**: 61-100.
- Brown, A. L., Bransford, J. D., Ferrera, R. A., & Campione, J. C. (1983). Learning, remembering, and understanding. Handbook of Child Psychology. M. J. H. Flavell, E. M. New York, Wiley. Vol. 3 Cognitive Development.
- Brown, A. L. and M. J. Kane (1988). "Preschool children can learn to transfer: Learning to learn and learning from example." Cognitive Psychology **20**: 493-523.
- Bruner, J. (1966). Toward a Theory of Instruction. Cambridge, MA, Harvard University Press.
- Bruner, J. (1976). Toward a Theory of Instruction. Cambridge, MA, Harvard University Press.

- Bruner, J. T. (1984). Vygotsky's Zone of Proximal Development: The Hidden Agenda. Children's Learning in the Zone of Proximal Development. B. Rogoff and J. Wertsch. San Francisco, CA, Jossey-Bass.
- Buckley, B. C. and C. J. Boulter (2000). Investigating the Role of Representations and Expressed Models in Building Mental Models. Developing Models in Science Education. J. K. Gilbert and C. J. Boulter, Kluwer Academic Publishers: 119-135.
- Burns, A. R., J. E. Houston, et al. (1999). "Friction and Molecular Deformation in the Tensile Regime." Physics Review Letters **82**: 1181–1184.
- Burrell, G. and G. Morgan (1979). Sociological Paradigms and Organizational Analysis. London, Heinemann Educational Books.
- Chan, C., J. Burtis, et al. (1997). "Knowledge building as a mediator of conflict in conceptual change." Cognition and Instruction.
- Chen, Z. and M. W. Daehler (1989). "Positive and negative transfer in analogical problem solving." Cognitive Development **4**: 327-344.
- Chi, M. T. H. (1992). Conceptual change within and across ontological categories: Examples from learning and discovery in science. Cognitive Models of Science: Minnesota Studies in the Philosophy of Science. R. G. ). Minneapolis, MN, University of Minnesota Press.
- Chi, M. T. H. and R. D. Roscoe (2002). The process and challenges of conceptual change. . Reconsidering conceptual change: Issues in theory and practice. M. Limon and L. Mason. Dordrecht, Kluwer Academic Publishers.
- Chinn, C. and W. Brewer (1993). Factors that influence how people respond to anomalous data. Fifteenth Annual Conference of the Cognitive Science Society, Boulder, CO, Cognitive Science Society.
- Clement, J. (1998). "Expert novice similarities and instruction using analogies." International Journal of Science Education **20**: 1271-1286.
- Cobb, P. (2005). Where is the mind? A coordination of sociocultural and cognitive constructivist perspectives. Constructivism: Theory, Perspectives and Practice. C. T. Fosnot. New York, Teachers College Press.
- Cohen, D. (1987). Behaviorism. The Oxford Companion to the Mind. R. L. Gregory. New York, Oxford University Press: 71.
- Cohen, L. and L. Manion (1994). Research Methods in Education. New York, NY, Routledge.
- Cosgrove, M. and R. Osborne (1985). Lesson frameworks for changing children's ideas. . Learning in science: the implications of children's science. R. Osborne and P. Freyberg. Auckland, Heineman.
- Denzin, N. K. (1989). The Research Act: A Theoretical Introduction to Sociological Methods. Engelwood Cliffs, NJ, Prentice Hall.
- DiSessa, A. and J. Wagner (2005). What Coordination Has to Say about Transfer. Transfer of Learning from a Modern Multidisciplinary Perspective. J. P. Mestre. Greenwich, CT, information Age Publishing Inc.
- diSessa, A. A. (1993). "Towards an epistemology of physics." Cognition and Instruction **10**(2-3): 105-225.
- diSessa, A. A. and B. L. Sherin (1998). "What changes in conceptual change?" International Journal of Science Education **20**(10): 1155-1192.
- Driver, R., Bell, B. (1986). "Students' thinking and the learning of science: A constructivist view." School Science Review **67**: 443-456.

- Driver, R. and J. Easley (1978). "Pupils and paradigms: A review of literature related to concept development in adolescent science students." Studies in Science Education **5**: 61-84.
- Duch, B. J. (1996). "Problem-Based Learning in Physics: The Power of Students Teaching Students." Journal of College Science Teaching **15**(5): 326.
- Edgen, P. D. and D. P. Kauchak (2004). Educational psychology : windows on classrooms. NJ, Upper Saddle River.
- Engelhardt, P. V., E. G. Corpuz, et al. (2003). The Teaching Experiment - What it is and what it isn't. Physics Education Research Conference, 2003, Madison, WI.
- Eylon, B. and U. Ganiel (1990). "Macro-Micro Relationships: The Missing Link Between Electrostatics and Electrodynamics in Students' Reasoning." International Journal of Science Education **12**: 79-94.
- Fauconnier, G. and M. Turner (2002). Conceptual Blending and Analogy. The Analogical Mind: Perspectives from Cognitive Science. D. Gentner, K. J. Holyoak and B. N. Kokinov. Cambridge, MA, MIT Press.
- Ferguson, E. L. H. (1995). "Learning with Real Machines or Diagrams: Application of Knowledge to Real-World Problems." Cognition and Instruction **13**(1): 129-160.
- Festinger, L. (1957). A Theory of Cognitive Dissonance. Stanford, CA, Stanford University Press.
- Franco, C. and D. Colinvaux (2000). Grasping Mental Models In Developing Models in Science Education. J. K. Gilbert and C. J. Boulter, Kluwer Academic Publishers: 93-118.
- Gentner, D. and A. L. Stevens (1983). Mental Models. Hillsdale, Lawrence Erlbaum.
- Gick, M. L., and Holyoak, K. J. (1980). "Analogical Problem Solving." Cognitive Psychology **12**: 306-355.
- Gilbert, J. K. and C. J. Boulter (1998). Learning Science through models and modeling. International Handbook of Science Education. K. Tobin and B. Frazer.
- Glaserfeld, E. (1989). "Cognition, construction of knowledge and teaching." Synthese **80**(1): 121-140.
- Greca, I. M. and M. A. Moreira (2002). "Mental, physical, and mathematical models in the teaching and learning of physics." Science Education **86**(1): 106-121.
- Gredler, M. (1997). Learning and Instruction Theory in Practice. New York, NY, MacMillan Publishing Cox.
- Greeno, J. G., J. L. Moore, et al. (1993). Transfer of situated learning. Transfer on trial: Intelligence, cognition and instruction. D. K. Detterman and R. J. Sternberg. Norwood, NJ, Ablex: 99-167.
- Griffiths, A. K. and K. R. Perston (1992). "Grade 12 students' misconceptions relating to fundamental characteristics of atoms and molecules." Journal of Research in Science Teaching **29**: 611-628.
- Gunstone, R. R., A. B. Champagne, et al. (1981). "Instruction for Understanding: A case study." Australian Science Teachers Journal **27**: 27-32.
- Hamed, K. M. (1999). Investigating Students' Understanding of Surface Phenomena, Ph.D. Dissertation. Physics. Manhattan, KS, Kansas State University.
- Hammer, D. (2000). "Student resources for learning introductory physics." American Journal of Physics, Physics Education Research Supplement, **68**(S1): S52-S59.
- Hammer, D. and A. Elby (2002). On the form of a personal epistemology. Personal Epistemology: The Psychology of Beliefs about Knowledge and Knowing. P. R. Pintrich and B. K. Hofer. Mahwah, N.J., Lawrence Erlbaum: 169-190.

- Hammer, D., A. Elby, et al. (2005). Resources, Framing and Transfer. Transfer of Learning: From a modern multidisciplinary perspective. J. P. Mestre. Greenwich, Connecticut, Information Age Publishing: 89-120.
- Hesse, J. J. I. and C. W. Anderson (1992). "Students' conceptions of chemical change." Journal of Research in Science Teaching **29**: 277-299.
- Hewson, P. W. (1981). "A conceptual change approach to learning science." European Journal of Science Education **3**(4): 383-396.
- Hoffding, H. (1892). Outlines of psychology. London, U.K., Macmillan.
- Holloway, I. (1997). Basic Concepts of Qualitative Research. Malden, MA, Blackwell Science Inc.
- Hrepic, Z. (2002). Identifying students' mental models of sound propagation. Physics. Manhattan, KS, Kansas State University.
- Hunt, E. and J. Minstrell (1993). A cognitive approach to the teaching of Physics. Classroom lessons: Integrating cognitive theory and classroom practice. K. McGilly.
- Ioannides, C. and S. Vosniadou (in press). "Exploring the changing meaning of force: From coherence to fragmentation." Cognitive Science Quarterly.
- Johnson-Laird (1983). Mental Models. Cambridge, Harvard University Press.
- Karplus, R. J. (1974). "Science teaching and development of reasoning." Journal for Research in Science Teaching **12**: 213-218.
- Kouka, A., S. Vosniadou, et al. (2001). The development of students' understanding of water as solvent. . Biennial Meeting of the European Science Education Association. Thessaloniki, Greece.
- Kovalik, S. and Olsen (1998). "The Physiology of Learning: Just What Does Go On in There?" Schools in the Middle **7**(4): 32-37.
- Krim, J. (1996). "Friction at the atomic scale." Scientific American.
- Krim, J. (2002). "Surface science and the atomic-scale origins of friction: What once was old is new again." Surface Science **500**: 741-758.
- Kurtz, K., C. H. Miao, et al. (2001). "Learning by analogical bootstrapping." Journal of Learning Sciences **10**: 417-446.
- Lave, J. and E. Wenger (1991). Situated learning: Legitimate peripheral participation. Cambridge, UK, Cambridge University Press.
- Lee, O., D. C. Eichinger, et al. (1993). "Changing Middle School Students' Conceptions of Matter and Molecules." Journal of Research in Science Teaching **30**: 249-270.
- Lesh, R. and A. E. Kelly (2000). Multitiered Teaching Experiments. Handbook of Research Design in Mathematics and Science Education. R. Lesh and A. E. Kelly. Mahwah, NJ, Lawrence Earlbaum Associates.
- Limon, M. and M. Caraterro (1997 ). "Conceptual change and anomalous data: A case study in the domain of natural sciences." European Journal of Psychology of Education **12**: 213-230.
- Lincoln, Y. S. and E. G. Guba (1986). Naturalistic Inquiry. Beverly Hills, CA, SAGE Publications.
- Lobato, J. E. (1996). Transfer Reconceived: How "sameness" is produced in mathematical activity, Ph.D. Dissertation. Education. Berkeley, CA, University of California, Berkeley: 254.
- Lockhart, R. S., M. Lamon, et al. (1988). "Conceptual transfer in simple insight problems." Memory and Cognition **16**: 36-44.

- Marton, F. (1986). Journal of Thought.
- Marton, F. (1986). "Phenomenography- a research approach to investigating different understanding of reality." Journal of Thought **21**: 29-39.
- McClelland, G. M., G. J. Germann, et al. (1993). "Atomic scale friction of a diamond tip on diamond (100) and (111) surfaces." Journal of Applied Physics **73**(1): 163-167.
- McCloskey, M. (1983). Naive theories about motion. Mental Models. D. Gentner and A. Stevens. Hillsdale, New York, Lawrence Erlbaum.
- McCombs, B. L. (1996). Alternative perspectives for motivation. Developing engaged readers in school and home communities. L. Baker, Afflerback, P, and Reinking, D. Mahwah, NJ, Erlbaum.
- McDermott, L. C. and E. F. Redish (1999). "Resource Letter: PER-1: Physics Education Research." American Journal of Physics **67**(9): 755-767.
- McInerney, D. M. and V. McInerney (2002). Educational Psychology: Constructing Learning, Prentice Hall
- Mertens, D. M. (2005). Research and Evaluation in Education and Psychology. Thousand Oaks, CA, SAGE Publications.
- Mikelskis-Seifert, S. and H. Fischler (2003). Can students develop meta-concepts for particle representation? Presenting an approach for introducing the particle model. D. Zollman. Kiel, Germany.
- Mikelskis-Seifert, S. and H. Fischler (2003). A multidimensional approach for analyzing and constructing teaching and learning processes about particle models. D. Zollman. Kiel, Germany.
- Muser, M. H. (2001). "Dry friction between flat surfaces:multistable elasticity vs. material transfer and plastic deformation." Tribology Letters **10**(1-2).
- Muser, M. H., E. Wenning, et al. (2001). "Simple Microscopic Theory of Amontons' Laws for Static Friction." Physical Review Letters **86**: 1295-1298.
- Nisbett, R. E., G. T. Fong, et al. (1987). "Teaching reasoning." Science **238**: 625-630.
- Norman, D. A. (1983). Some observations on mental models. Mental models. D. A. Gentner and A. L. Stevens. Hillsdale, NJ, Lawrence Erlbaum.
- Novak, J. (1977). A theory of education. Ithaca, Cornell University Press.
- Novick, L. (1988). "Analogical transfer, problem similarity, and expertise." Journal of Experimental Psychology: Learning, Memory & Cognition **14**: 510-520.
- Park, J. (2006). "Modeling Analysis of Students' Processes of Generating Scientific Explanatory Hypotheses." International Journal of Science Education **28**(5): 469-489.
- Patton, M. Q. (1990). Qualitative Evaluation and Research Methods. Newbury Park, CA, SAGE Publications.
- Pavlov, I. P. (1927). Conditioned Reflexes. London, Oxford.
- Perfetto, G. A., Bransford, J. D., Franks, J. J. (1983). "Constraints on access in a problem solving context." Memory and Cognition **11**: 12-31.
- Phillips, D. C. (1995). "The good, the bad and the ugly: The many faces of constructivism." Educational Researcher **24**(7): 5-12.
- Piaget, J. (1964). "Development and Learning." Journal of Research in Science Teaching **2**(3): 176-186.
- Pintrich, P. R. and D. Schunk (1996). Motivation in Education: Theory, Research and Application. Columbus, OH, Merrill Prentice-Hall.

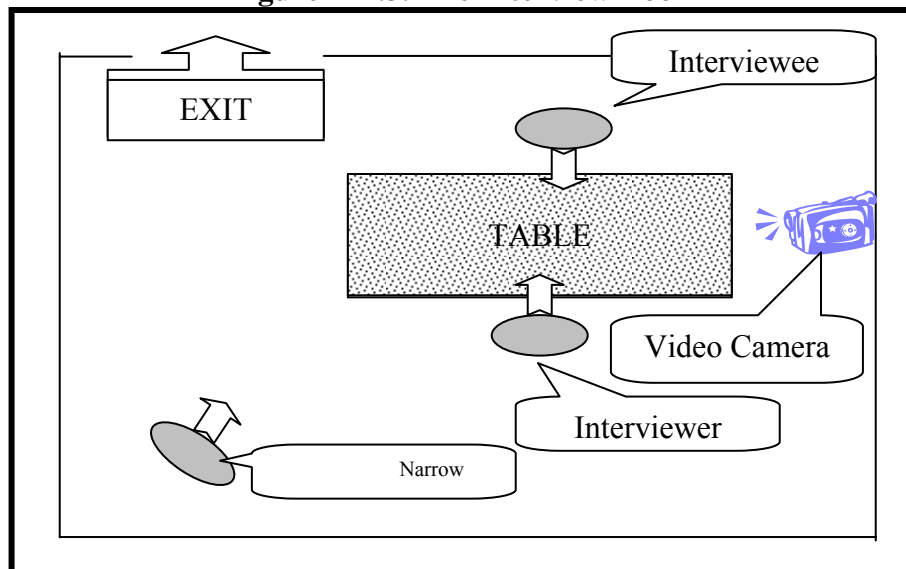
- Pintrich, P. R., Schunk, D. (1996). Motivation in Education: Theory, Research and Application. Columbus, OH, Merrill Prentice-Hall.
- Posner, B., K. Strike, et al. (1982). "Accommodation of a scientific conception: Toward a theory of conceptual change." Science Education **66**: 211-227.
- Rebello, N. S., D. A. Zollman, et al. (2005). Dynamic Transfer: A Perspective from Physics Education Research. Transfer of Learning from a Modern Multidisciplinary Perspective. J. P. Mestre. Greenwich, CT, Information Age Publishing Inc.
- Redish, E. F. (1994). "The Implications of Cognitive Studies for Teaching Physics." American Journal of Physics **62**(6): 796-803.
- Redish, E. F. (2004). A Theoretical Framework for Physics Education Research: Modeling Student Thinking. International School of Physics, "Enrico Fermi", Course CLVI, Varenna, Italy, Italian Physical Society.
- Reed, S. K. (1993). A schema-based theory of transfer. Transfer on trial: Intelligence, Cognition and Instruction. D. K. Detterman and R. J. Sternberg. Norwood, NJ, Ablex: 39-67.
- Reed, S. K., G. W. Ernst, et al. (1974). "The role of analogy in transfer between similar problem states." Cognitive Psychology **6**: 436-450.
- Reiner, M., J. D. Slotta, et al. (2000). "Naive physics reasoning: A commitment to substance-based conceptions." Cognition and Instruction **18**(1): 1-34.
- Rennie, L. J. and L. H. Parker (1996). "Placing Physics Problems in Real-Life Context: Students' Reactions and Performance." Australian Science Teaching Journal **42**(1): 55-59.
- Robbins, M. O. and M. H. Muser (2001). Computer Simulations of Friction, Lubrication and Wear. Modern Tribology Handbook. B. Bhushan. Boca Raton, CRC Press.
- Robbins, M. O. and J. Ringlein (2004). "Understanding and illustrating the atomic origins of friction." American Journal of Physics **72**(7): 884-891.
- Rouse, W. B. and N. M. Morris (1986). "On looking into the black box: Prospects and limits in the search for mental models." Psychological Bulletin **100**(3): 349-363.
- Skinner, B. F. (1953). Science and Human Behavior. New York, Macmillan.
- Steffe, L. P. (1983). The Teaching Experiment Methodology in a Constructivist Research Program. Fourth International Congress on Mathematical Education., Boston, MA, Birkhäuser.
- Svennson, L. and T. J. (1983). A Case of Phenomenographic Research.
- Swartz, C. E. and T. Miner (1997). Teaching Introductory Physics: A Resource Book. Woodbury, NY, AIP Press.
- Thagard, P. (1990). "Concepts and conceptual change." Syntheses **82**: 255-274.
- Tomassone, M. S., J. B. Sokoloff, et al. (1997). "Molecular Dynamics Simulation of Friction in Xenon Films on a Silver Substrate." Phys. Rev. Lett. **79**(24 ): 4798-4801.
- Unal, R. (1996). Students' Perception of an Atom. Physics Department, Kansas State University.
- van Manen, M. (1990). Researching Lived Experience: Human Science for an Action Sensitive Pedagogy. New York, State University of New York Press.
- Viennot, L. (1979). "Spontaneous reasoning in elementary dynamics." European Journal of Science Education **1**: 205-211
- Vosniadou, S. (1994). "Capturing and modeling the process of conceptual change." Learning and Instruction **4**: 45-69.
- Vosniadou, S. (1994). "Capturing and modeling the process of conceptual change." Learning & Instruction **4**: 45-69.

- Vosniadou, S. (2002). On the nature of naïve physics. Reconsidering conceptual change: Issues in theory and practice L. Limón and M. Mason. Dordrecht, Kluwer Academic Publishers.
- Vosniadou, S. and W. Brewer (1992). "Mental Models of the Earth: A study of conceptual change in childhood." Cognitive Psychology **24**: 535-585.
- Vygotsky, L. S. (1978). Mind in Society: The development of Higher Psychological Processes. Cambridge, Harvard University Press.
- Watson, J. B. (1912). "Psychology as the Behaviorist Views it." Psychological Review **20**: 158-177.
- Wells, M., D. Hestenes, et al. (1995). "A Modeling Method for High School Physics Instruction." American Journal of Physics **63**: 606-619.
- White, R. W. (1959). "Motivation reconsidered: The concept of competence." Psychological Review **66**: 297-333.
- Wilson, J. M. (1994). "The CUPLE Physics Studio." The Physics Teacher **32**: 518-523.
- Wittmann, M. C., R. N. Steinberg, et al. (2002). "Understanding and Addressing Student Reasoning about Sound. Manuscript submitted for publication."
- Woolfolk, A. (2001). Educational psychology. Needham Heights, MA, Allyn and Bacon.

## Appendix A - The Interview Room Set-up

The physical set-up for the clinical interviews is shown in Figure A-1. The interview room was made unobtrusive to the students as much as possible. We deliberately have them seated near the exit, that way they can easily move out if they need to. The video was set up on a tripod that is located to the side of the interviewees. A television monitor was hooked up on the video camera and interviewees are asked to briefly look at it before every interview session so as to make them aware of what I am capturing during the interview. To maintain anonymity of the subjects we made sure that their faces don't show up in the video. Basically, the video captures hand gestures, pictorial representations, written and verbal expressions.

Figure A-7.3. The Interview Room





# Appendix B - The Clinical Interview Protocols

## INTERVIEW PROTOCOL

### **Purpose of the Interview:**

This interview is being conducted in order to establish students' existing ideas about friction and some related physical phenomena involving friction both at the macroscopic and microscopic level. Results of the interview will be useful in designing instruction to help students understand physical phenomena involving friction at the microscopic level.

Your responses during the interview will not be graded and rest assured that they will remain confidential. Your ideas are important to us. So, please feel free to express them.

### **Target Participants:**

Students enrolled in "Contemporary Physics"

### **Interview Proper:**

#### **Day 1: Students' Ideas about surfaces and friction**

##### *Students' Ideas about surfaces*

I have here a block of wood. Please try to feel the bottom surface by rubbing your fingers across it.

If you just consider a very small part (say 1 square cm) of the surface, what might you see if you view this through a magnifying glass? Please sketch what you might see. (each square on the graphing paper corresponds to one-tenth of a **millimeter**).

If you just consider one square on your diagram, what might you see if you view it through a microscope with a precision of up to 0.1 micrometer. Please sketch what you might see. (each square on the graphing paper corresponds to one-tenth of a **micrometer**)

Again, just consider one square in your sketch and please describe to me what you might see if you view it through a powerful microscope with precision of up to 0.1 nanometer? Please sketch what you might see. (each square on the graphing paper corresponds to one-tenth of a **nanometer**)

Now if I let the block rest on the table surface, will there be changes in the sketches you previously made? If so, what are these?

### *Student Ideas on Static and Kinetic Friction*

Suppose you pull the block horizontally using the spring scale. Describe what do you think would happen in the reading on the spring scale if you use it to make the block move.

Now, pull the block slowly using the spring scale and observe what happens to the force.

How much force was needed in order to start the block moving?

Why is it that when the force applied is less than \_\_\_\_\_, the block didn't move?

How does the force needed to start the block moving compare to the force needed to keep it moving across the top of the table, once it has started moving?

Now, please take time to think about how you might explain in your own words why the block behaves as it does in the following situations: (Feel free to use diagrams to explain your reasoning)

- a. before the block starts to move
- b. as the block starts to move
- c. while the block is moving

What would the situations look like if you view them through a magnifying glass (each square on the graphing paper corresponds to one millimeter)? Please sketch and explain what you think you might see:

- a. before the block starts to move
- b. as the block starts to move
- c. while the block is moving

What would the situations look like if you view them through a microscope (each square on the graphing paper corresponds to one-tenth of a **micrometer**)? Please sketch and explain what you think you might see:

- a. before the block starts to move
- b. as the block starts to move
- c. while the block is moving

What would the situations look like if you view them through a very powerful microscope (each square on the graphing paper corresponds to one-tenth of a **nanometer**)?. Please sketch and explain what you think you might see:

- a. before the block starts to move
- b. as the block starts to move
- c. while the block is moving

Would your sketch in each case be the same/different if we put oil in between the surfaces? If so, who would it be same/different?

## Day 2: Students' Ideas on the Effect of Surface Area and Lubrication

### Students' Ideas on the Effect of Surface Area

Now place the block lying on its other surface. Predict how the results here would be different / same with the previous case.

Pull the block using the spring scale and start it moving across the top of the table.

How much force was needed in order to start the block moving across the table surface in this case? How does this force compare to the previous case?

What makes the results here different from the previous case?

Predict what happens to the reading on the spring scale when we add weight to the block in the following stages:

- a. before the block starts to move
- b. as the block starts to move
- c. while the block is moving

Now slowly start the block moving by pulling on the spring scale. Note the reading on spring scale before the block starts to move, as the block is moving and while the block is moving. So how is the result different/same from your prediction?

So what do you think is happening here? Please explain what happens if we add weight on the block. You can use diagrams/sketches to in your explanations.

### Student Ideas on Lubrication

Can you please give situations where friction is desired? (Lead interviewee to mention walking i.e. Can you possibly get from here to there without friction? So where else is friction desired?)

Friction is absolutely desired when walking along a road. Let's discuss the interaction between your shoe sole and the road. Could you please describe how the shoe sole interacts with the road and how friction comes into play. (assume the road is dry)

How would the interaction look like if you view through a magnifying glass? Please sketch and explain what you might see. (assume that each square on the graphing paper corresponds to one millimeter)

How would the situation look like if you view it through a microscope? Please sketch and explain what you think you might see (assume that each square on the graphing paper corresponds to one-tenth of a micrometer)

# Final Version of the Clinical Interview Protocol

## Purpose of the Interview:

This interview is being conducted in order to establish students' existing ideas about friction and some related physical phenomena involving friction both at the macroscopic and microscopic level. Results of the interview will be useful in designing instruction to help students understand physical phenomena involving friction at the microscopic level.

Your responses during the interview will not be graded and rest assured that they will remain confidential. Your ideas are important to us. So, please feel free to express them.

## Target Participants:

Students enrolled in "Contemporary Physics"

## Interview Guide (Day 1)

### Students' Ideas about surfaces and friction

#### *Students' Ideas about surfaces*

- ✚ I have here a block of wood. Could you please feel the bottom surface by rubbing your fingers across it.
- ✚ Based on what you did, could you please sketch on the graphing paper how a 10cm length of the surface would look like?
- ✚ Now just consider 1 mm (1/100 of the entire sketch) portion of your sketch. How would this portion look like if this is magnified 100 times?
- ✚ Again, just consider 1/100 of what you've just sketched. How would this portion look like if magnified 100 times?
- ✚ Do what you've just done two more times.
- ✚ If you keep zooming in, will there be a point where your sketch would look significantly different from you previous sketches?
- ✚ Now if I let the block rest on the table surface, will there be changes in the sketches you previously made? If so, what are these?

#### *Student Ideas on Static and Kinetic Friction*

- ✚ Suppose you pull the block horizontally using the spring scale. Predict what you think would happen in the reading on the spring scale if you use it to make the block move.
- ✚ Now, pull the block slowly using the spring scale and observe what happens to the reading on the spring scale.
- ✚ How much force was needed in order to start the block moving?
- ✚ Why is it that when the force applied is less than \_\_\_\_\_, the block didn't move?
- ✚ Could you please explain what is happening between the two surfaces as you try to move the block across the surface? (Let student explain it at the smallest level previously thought of)

- ✚ So what causes friction between the surfaces?
- ✚ How does the force needed to start the block moving compare to the force needed to keep it moving across the top of the table, once it has started moving?
- ✚ Now, please take time to think about how you might explain in your own words why the force needed to start the block moving is greater than the force needed to keep it moving.  
Student Ideas on Lubrication
- ✚ Would your sketch in each case be the same/different if we put oil in between the surfaces? If so, how would it be same/different?
- ✚ What would happen if we put water instead? How would your sketches be different?
- ✚ What are the ways in which you can reduce friction between two surfaces?

## **Interview Guide (Day 2)**

### *Surface Area*

- ✚ In your own opinion, with other variables constant (e.g. roughness or smoothness) how does the surface area affect friction?
- ✚ (We may need to show the movie to show the effect of surface area <http://www.nano-world.org/frictionmodule/content/0200makroreibung/0100leonardo/?lang=en> )
- ✚ Could you please explain what is happening? (Let student explain it at the smallest level that he came up with)
- ✚ How does the area of contact between a masking tape and another surface affect friction? Could you please explain this mechanism? (Again lead student to explain it at the smallest level that he came up with)

### *Effect of Gravity & Mass Dependence of Friction*

- ✚ Please predict what happens to the force needed to start the block moving if we double its mass.
- ✚ Add some weight on top of the block and try to start it moving by slowly increasing the force on the spring scale.
- ✚ Why do you think the force increased?
- ✚ Could you please explain what is happening between the surfaces when you added weight? (explanations should be at the smallest level that students came up with)
- ✚ Suppose you do the activity (dragging of wooden block across a wooden surface) on the moon. What will be different on your previous explanations regarding the behavior of the block?

## Appendix C - The Teaching Interview Protocols

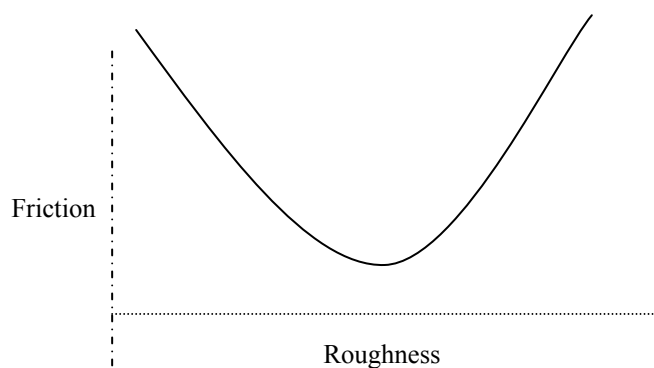
### Initial Version of the Protocol

Target Idea/s:

- Friction is dependent on the actual surface area of contact.

$$F = \mu N + cA$$

- Friction increases when materials get very rough or very smooth.



#### Introduction:

Today we will study the interactions of different surfaces that come into contact with each other. As we go along, you will be doing activities which hopefully will help you learn.

**Exploration Activities:** (: *Pulling of wooden block along its bare surface and along the surface with sandpaper*)

Could you please predict what happens to the reading on the spring scale as we try to move the block using it?

Why is it that we need a finite amount of force in order to start the block moving? (Lead students to think of friction as the reason why)

Could you please predict how the force needed to start the bare block moving across the wooden plank compare with the force needed to start the same block but dragged across the surface with sandpaper?

*(Activity: Pulling of wooden block along its bare surface and along the surface with sandpaper)*

Please sketch what you think the different surfaces (surface with sandpaper, surface of bare wooden block, surface of the wooden plank) look like at the atomic level.

Based on your sketches could please explain why the force needed to start the block moving along the surface with sandpaper is relatively larger than the force needed to start the block moving if dragged along its bare surface.

How does surface roughness affect friction? (Students might initially say that the rougher the surface is, the greater is the friction)

**Next let students do the activity on the gage blocks.**

Slide your fingernail on the two surfaces. How does the surface roughness/smoothness compare?

Please sketch what the two surfaces look like at the atomic level.

Could you please predict how the friction relatively compare in the two situations: smooth vs. rough and smooth vs. smooth

Let students slide the gauge block across the two types of surfaces.

Please explain what you observed.

How does the number of atomic contact compare in the two situations?

Lead students realize the role of the real area of contact in explaining the phenomena. (e.g. Let students imagine they zoom in on the interface and are able to look at it at the atomic level, how would the number of atoms in contact compare between the two situations)

Supplementary Activity:

CD Activity:

- Let students feel the surfaces of the CD
- Predict in which case the friction will be greater if they slide one of their fingers across the surfaces putting some pressure on it.
- Let them do activity.
  
- Have students explain what they observed.

Which of the situations previously considered partly explains the mechanism of non-stick pans?

Show them the video on the block being dragged along its different surfaces across a conveyor belt.

Explain the macroscopic observation that friction is the same for different apparent areas of contact. (e.g. rectangular block of wood dragged along its different surfaces produce the same amount of friction)

Target Idea: Ultimately friction is due to electrical interactions.

Exploration:

Plastic surface vs. plastic

Balloon

Let students predict in which case they will have greater friction: “uncharged balloon rubbed against a surface or a charged balloon rubbed against the same surface.

Slide the uncharged balloon on a sheet of paper. Now charge one of the balloons by rubbing it to your pants and slide it across on the sheet of paper.

In which case is the friction relatively greater?

Why is the friction greater in that case? (Lead students to think that there are more charges involved with the charged balloon so there will be greater electrical interaction hence greater friction)

### **Application:**

Let students explain what is happening in the metal block and CD situations in terms of the electrical interactions.

Lead students come up with their own theory of how friction is produced at the atomic level. (Hopefully at this point, students can be led to consider the fact that ultimately friction is due to electrical interactions. If not, think of alternative activities)

### **3. Target Idea: Friction is finite even if there’s no gravity (negative load).**

Exploration:

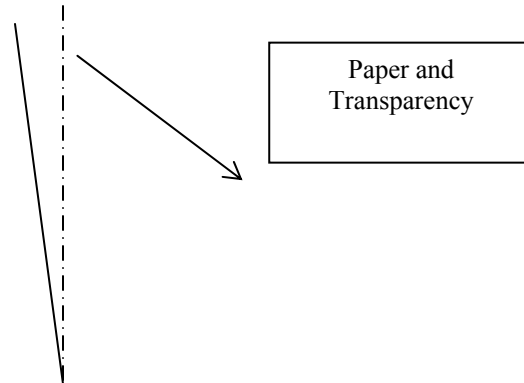
Please draw the forces acting on a paper sheet and a transparency lying horizontally. Highlight the direction of the force due to gravity.

How does gravity contribute to the friction between the two surfaces? (Student tend to think that gravity is friction?)

Will there still be friction if gravity is zero?



Is there an orientation of the interface between the paper and plastic sheet wherein gravity no longer push the surfaces against each other? ( If they can't recognize the orientation the let students draw the direction of the forces when the system is oriented as shown in the figure below)



Will there still be friction if we have the paper and transparency oriented in this way?

Do the activity (tilting of the interface slightly past  $90^\circ$ )

Please explain what you observed.

Is friction necessarily zero when gravity is zero?

## Teaching Interview Protocol (Final Version)

### The target ideas:

Friction is due to electrical interactions of atoms.

Friction is dependent on the atomic contact area.

Friction on atomically smooth surfaces is large.

Friction varies with roughness as in Figure 1.

Atomic friction is described by the equation

$$f = \mu N + cA$$

Where

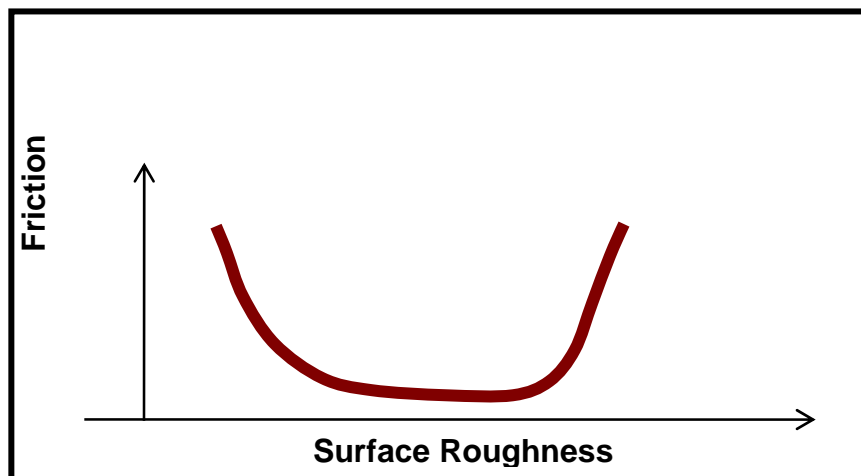
‘ $\mu$ ’ is the coefficient of friction

‘ $N$ ’ is the force of normal reaction on the surface

‘ $c$ ’ is the force needed to dislodge each atom.

‘ $A$ ’ is the number of atoms.

Figure 1. Target Model of Friction vs. Surface Roughness



### *Introduction:*

Today we will study the interactions of different surfaces that come into contact with each other.

As we go along, you will be doing activities which hopefully will help you learn.

### **Activity #1: *Feeling and sketching of surfaces.***

- Please feel the surfaces by rubbing your fingers across each.
- How would you compare the surfaces?
- Sketch what the surfaces would look like to you at the level where you see the atoms.

### **Activity #2. Pulling of wooden block along its bare surface and along the surface with sandpaper**

- If we pull the block on one end of the spring scale, could you please predict what happens to the reading as we move the block across the different surfaces (sandpaper and wooden plank)
- Why is it that we need a finite amount of force in order to start the block moving? (Lead students to think of friction as the reason why.)
- If we drag the block along the wooden plank and along the surface with sandpaper, could you please predict how the friction force would compare in the two situations?

### **After Activity #2**

- Please sketch what you think the different surfaces (surface with sandpaper, surface of bare wooden block, surface of the wooden plank) look like at the atomic level.
- Based on your sketches can please explain why the friction force is different when we dragged the block across the wooden plank and when we dragged it across the surface with sandpaper?  
How does surface roughness affect friction?

Activity #3. Graphing of friction force vs. roughness of the surfaces..

- Please make a graph on how friction force would vary with the roughness of the sliding surfaces.
- Explain the details of your graph.
- What happens to the friction force as the surfaces become rougher and rougher?
- What happens to the friction force as the sliding surfaces become smoother and smoother?

### **Activity #4. Metal Blocks Activity**

- Slide your fingernail on the two surfaces. How does the surface roughness/smoothness compare?
- Please sketch what the two surfaces would look like at the atomic level.
- Predict how the friction force compare when we slide the smooth surface of the metal block to the other smooth surface and the case where we slide the smooth on the rougher sides. Explain your prediction.
- Explain your observation.

### **Activity #5. Papers & Transparency Activity**

- How do the apparent areas of the crumpled and uncrumpled paper compare?
- Suppose we slide the two sheets of paper across the transparency one at a time. Could you please predict how the friction force between the transparency and crumpled paper compare with the friction force between the transparency and the uncrumpled paper?
- Why do you predict that?  
Could you please explain your observation?
- Could you please sort of relate what you have just observed here with that of what is happening with the metal blocks?  
How does the number of atomic contact compare in the two situations?
- Rubbed the transparency with the fur. Again slide the crumpled and uncrumpled one after the other.  
Explain your observation.

(Other Scaffolding: Have students draw the pairs of sliding surfaces)

### **Activity # 6. Modifying Previous Graph**

Do you still go with your previous graph. If not, how would you modify it.

Explain the details of your new graph.

- What happens to the friction force as the surfaces become rougher and rougher?
- What happens to the friction force as the sliding surfaces become smoother and smoother?

Activity # 7. Dragging of Wooden Block on its wide and narrow sides

- If you are to drag this wood block along its wide then on its narrow side across the wooden plank surface, how would the force compare?
- In which case will you have greater friction?
- Explain your observation

**Activity # 8. Balloon Activity**

- How would you represent the wide and narrow sides of the wooden block using this balloons?
- Predict what would happen if we let the balloon arrangement representing the wooden block surface rest on the paint tray.
- Explain your observation
- How would you relate what you have done with what you observed with the wooden block?

**Activity # 9. Mathematical Modeling (EP Students)**

- Going back to the wooden on the sandpaper/wood plank surface, how would you compute the friction force?
- Let's consider your sketches (at the atomic level) of the pair of metal block surfaces. What are the factors that we need to know in order to determine the total force that we need to pull the surfaces across each other.
- If we denote  $c$  as the force needed to overcome the electrical interaction between pairs of atoms, what other factors do we need to consider? How would you calculate the force to pull.
- Going back to your modified graph, in which regions would those factors dominate.
- Write a general expression for computing the friction force.

 **Five-Minute Paper**

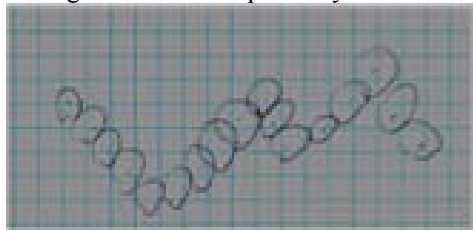
 **Post-Activity Interview**

-----END OF TEACHING INTERVIEW -----

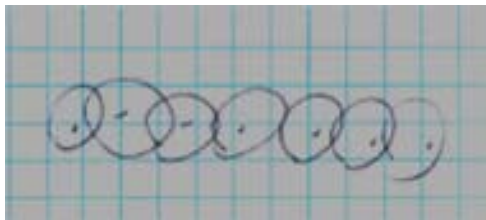
## Appendix D - The Scaffolding Activities

### Activity #1. Feeling and Sketching of Rough & Smooth Surfaces

In this activity students are asked to slide their fingers across a wooden block surface, the sandpaper surface and the wooden plank surface. Students were then asked to sketch the different surfaces at different length scales down to the level where they presume to see the atoms. Typically students would be making sketches of rough and smooth surfaces as shown in Figures 1 and 2 respectively.



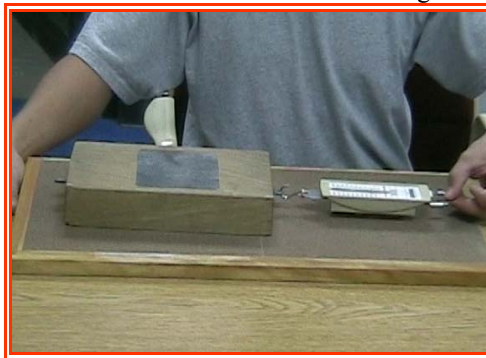
**Figure 1: Sketch of a rough surface**



**Figure 2: Sketch of a smooth surface**

### Activity #2. Dragging of Wooden Block across a Wooden Plank and Sandpaper Surface

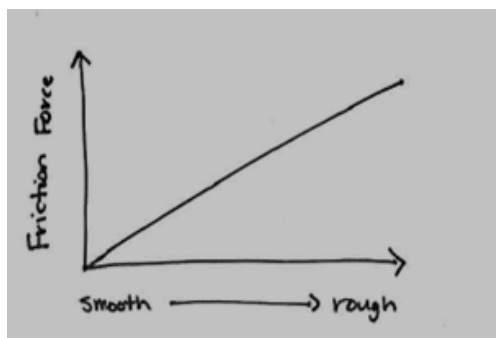
In this activity, students were first asked to predict how the force needed to pull the wooden block across the two different surfaces would compare. They were then asked to give reasons for their predictions before dragging the wooden block across the two different surfaces and describing their observations.



**Figure 3: Dragging of wooden block**

### Activity #3. Graphing the variation of friction with surface roughness of both surfaces

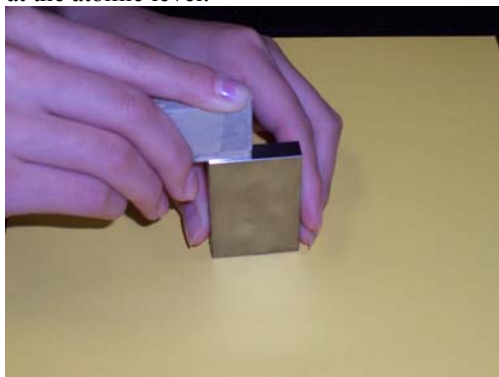
Students were asked to sketch a graph showing how friction force varies with the surface roughness of pairs of sliding surfaces. They were also explicitly asked to explain the details of their graph. Figure 4 shows a typical sketch of the students which shows a steadily increasing friction force with surface roughness.



**Figure 4: Initial graph of friction force vs. roughness of surfaces**

#### Activity #4. Metal Block Activity

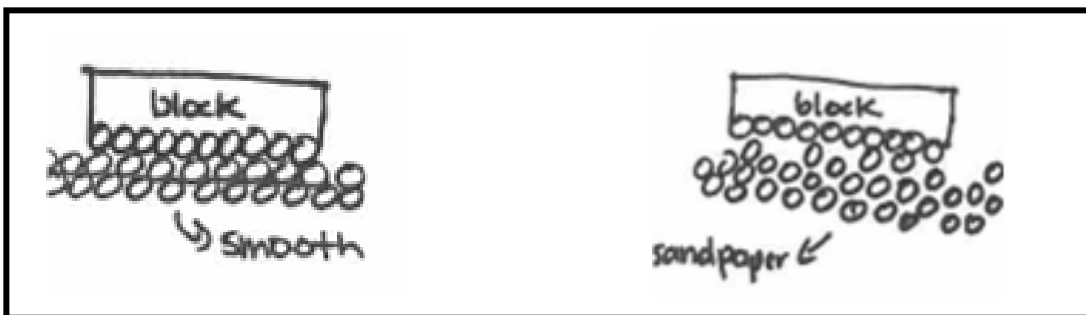
The purpose of this activity was to challenge students' prior ideas about friction. In this activity, students explored friction between a very smooth pair of surfaces of metal blocks and a smooth-rough pair of surfaces of the same metal block (see Figure 5). Students were first asked to compare the smoothness of the different surfaces of the metal block by letting them slide their fingernails across the different surfaces. They were then asked to give their prediction and reasons for their predictions of the pair of surfaces for which the friction would be greater. Students tended to predict that there will be more friction between the smooth-rough pair of surfaces because there will be more "interlocking." However, after doing the activity, they would later find out that it would be harder to slide the smooth-smooth pair of surfaces across each other rather than the smooth-rough pair of surfaces. This activity engaged students in cognitive conflict which they mostly resolved through other activities that followed. Through this activity students' current ideas were challenged. This put the students in a mode of considering alternative explanations of friction at the atomic level.



**Figure 6: Metal Blocks**

#### Activity #5. Sketching the Pairs of Sliding Surfaces at the Atomic Level

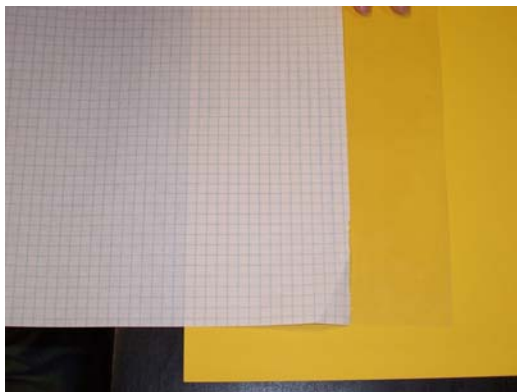
Students were explicitly asked to draw a sketch of the pairs of sliding surfaces at the level at which they could 'see' the atoms. The sketches that they drew here were quite similar to what they had sketched previously in Figures 1 and 2. (i.e. the smooth surface is represented with atoms lining up and rough is represented with atoms in an uneven pattern). This activity provided another context in which students were given the opportunity to reconsider alternative explanations about friction at the atomic level. Figure 7 shows a typical response from the students.



**Figure 7: Sketch of pairs of sliding surfaces.**

#### Activity #6. Paper-Transparency Activity

Students were provided with a transparency and plane sheet of paper. They were asked to first rub the transparency with the fur and then slide the sheet of paper across it. Student typically noticed that they needed to exert a force to pull a flat sheet of paper across the transparency rubbed with fur. Next they crumpled the sheet same sheet into a ball and after straightening it out they were asked to pull a the sheet across the same transparency. Most students noticed that it was much easier to pull the crumpled sheet of paper across the transparency compared to the flat sheet of paper.



**Figure 5: Paper over a transparency**

This activity was used to resolve the cognitive conflict brought about by the metal gage block activity. Through this activity students were provided clues to the role of electrical interactions and the real area of contact between two surfaces.

#### Activity #7. Sketching of pairs of Sliding surfaces at the Atomic Level

In this activity students sketched the pairs of sliding surfaces (flat sheet of paper over the transparency and crumpled sheet of paper over the transparency) at the atomic level. This activity was designed to help student reconsider their previous explanations about friction at the atomic level. The activity provides them another context in which they resolve the conflict in the metal gage block activity (#4). By comparing their sketches of the metal block surfaces and the paper and transparency pair students realized how the real area of contact was coming into play in the interactions between the two surfaces.

#### Activity #8. Relating the Paper-Transparency Activity with the Metal Blocks Activity

Later in the teaching interview students were explicitly asked to relate their observations in the paper-transparency activity with the metals blocks activity. Through this activity, students came to realize that friction can be large when surfaces become smooth because the real area of contact increases. The real area of contact in this case is not necessarily the visible area of the surface. Rather it is the sum total of the area of the individual atoms

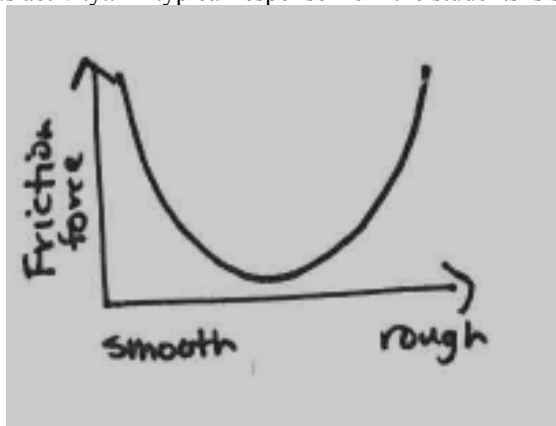
contacting each other. As the real area of contact increases, the electrical interactions between the surfaces become more pronounced.

#### Activity #9. Revisiting the Friction vs. Roughness Graph

Students were explicitly directed to go back and make sense of their previous of friction vs. roughness in the light of the new phenomena studied. The purpose of this was to make students reflect on their initial graph and realize that their initial graph was not necessarily consistent in light of the activities that they had just completed.

#### Activity #10. Modifying their Model of Microscopic Friction

In this activity the students were explicitly provided the opportunity to revise their initial model how friction varies with the surface roughness and represent this model on the graph of Friction vs. Surface roughness that they had revisited in the previous activity.. A typical response from the students is shown in Figure 9.



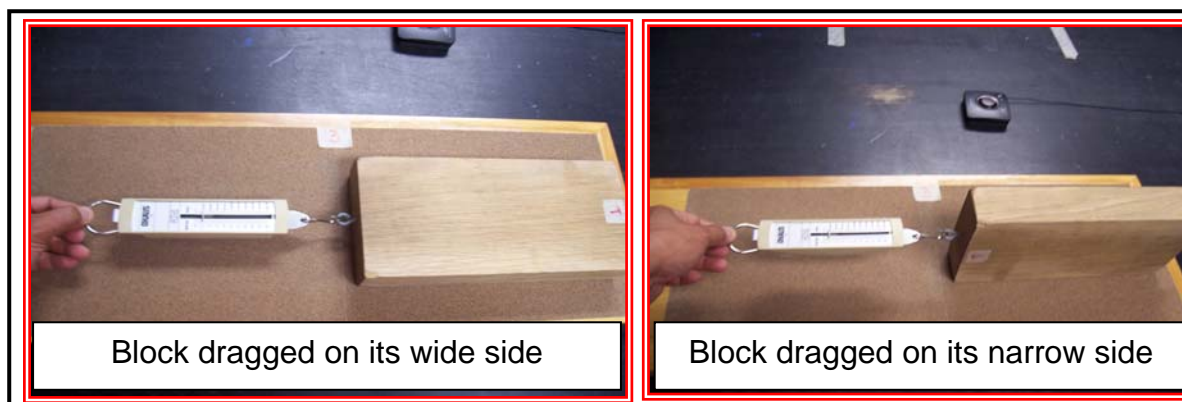
**Figure 6: Modified graph of friction force vs. roughness of surfaces.**

Students were also asked to describe what happened at the atomic level and the factors that influenced the force of friction. Most students at this point, based on the Paper & Transparency activity (#6) realized that it was the 'real' area of contact at the atomic level that determined the force of friction. The crumpled paper and flat paper both had the same area (they were identical), but the flat sheet made contact with the transparency at more points than the crumpled sheet, so it experienced more friction

#### Activity #11. Dragging of Block along its wide and Narrow Side

We again challenged students' ideas regarding the surface area of contact by having them explore the friction when the wooden block is dragged across its wide and then its narrow side (see Figure 5-10). Here, based on their ideas developed above of how friction depended upon real area of contact in the previous activity (#10) students would typically predict that the wooden block dragged along its wide side would experience greater friction. Their prediction would be contradicted by their observation that the force of friction actually ends up being the same regardless of whether the block is on its wide or narrow side.





**Figure 10. Block dragged along its wide and narrow sides**

### Activity #12. The Balloon Activity

In this activity, students modeled the atoms of the surfaces as balloons (see Figure 11). Based on the number of atoms on each side of the block, students represented the wide side with more balloons and the narrower side with fewer balloons. Students rested the balloon arrangement on a tray with paint smeared on the surface and then they made sense of what the paint marks on the balloons represented. The paint marks on the balloon are analogous to the real area of contact between the surfaces.



**Figure 7: Balloon Activity**

Students noticed that when the box rested on its wide side with more number of balloons the paint marks on each of the balloons were smaller than when the box rested on its narrower side with fewer balloons. They realized that this was because in the first case the weight of the box was distributed over more balloons than in the second case, therefore pushing down less on each individual balloon. Thus the contact area made by each atom on the surface would be smaller when the wooden block was rested on its wider side. However, the number of atoms was proportionally larger when the block was rested on its wide side. Students realized that the product of these two factors – the ‘real’ contact area made by an individual atom and the number of atoms in contact equaled out in the two cases, therefore explaining their observation that the force of friction was the same in the two cases.

### Activity #13. Mathematical Modeling

Mathematical modeling was done with some students enrolled in the algebra-based and calculus-based introductory physics courses. Participants enrolled in the conceptual physics-based courses (‘Physical World’ and ‘Concepts of Physics’) did not engage in mathematical modeling.

## Appendix E - Research Plan

### Overall Research Plan

Proposed Strategy	Resources	Goals	Methodology Guide Notes
<b>Hypotheses, Goals &amp; Benchmarks</b>			
Read thoroughly the CAREER Research Proposal.	CAREER Research Proposal	Generate goals and benchmarks of the research that is consistent with the goals of the Career Research Project	Ensured that goals of the research resonate with the goals of the CAREER research project.
<b>Adopting Philosophical Standpoint</b>			
<ul style="list-style-type: none"> <li>➤ Review different theories about Models/Model Building, Conceptual Change, Constructivism and Transfer.</li> <li>➤ Talk to members of the KSU PER Group who have strong background about the different theories of learning and teaching.</li> </ul>	<ul style="list-style-type: none"> <li>➤ Books on Models/Modeling, Theories of Learning</li> <li>➤ Research on Modeling</li> <li>➤ Research on Promoting Conceptual Change, Constructivism and Learning</li> <li>➤ CAREER Research Proposal</li> <li>➤ KSU PER Group Members</li> </ul>	Have a clear understanding of the theoretical underpinnings of the research.	Discussed and reflected on the ideas discussed in literature about friction, modeling, conceptual change and transfer.

**Overall Research Plan - Continued**

<b>Proposed Strategy</b>	<b>Resources</b>	<b>Goals</b>	<b>Methodology Guide Notes</b>
<b>Adapt and/or Design Data Collection Instruments</b>			
Design the Protocols for the Clinical Interviews	<ul style="list-style-type: none"> <li>➤ KSU PER Group Members</li> <li>➤ Researchers on Atomic Friction</li> <li>➤ Literature on Atomic Friction</li> <li>➤ Students' Pre-Existing Mental Models of Atomic Friction</li> </ul>	Design appropriate data collection instrument that would enable one to generate data that would answer the research questions	<ul style="list-style-type: none"> <li>➤ Solicited feedback from different members of the research group.</li> <li>➤ Pilot tested Protocols.</li> <li>➤ Revised protocols based on the feedback from the pilot test.</li> </ul>
Design the Protocol for the Teaching Interviews			

### Overall Research Plan - Continued

Proposed Strategy	Resources	Goals	Methodology Guide Notes
<b>Data Collection</b>			
Do Clinical Interviews with Students	Introductory College Physics Students at KSU (PWorld, GP 1, GP 2, EP1, EP2, Contemporary Physics Students)	Generate Students' Pre-Existing Mental Models about friction at the atomic level	<ul style="list-style-type: none"> <li>➤ Schedule student interviews.</li> <li>➤ Follow IRB Protocol – consent form at the beginning of interview.</li> <li>➤ Follow interview protocol.</li> <li>➤ Collect demographic data from students</li> <li>➤ Videotape and audiotape the interviews</li> <li>➤ Keep observation notes</li> </ul>
Do Teaching Interviews	Introductory College Physics Students at KSU (PWorld, GP 1, GP 2, EP1, EP2, Contemporary Physics Students)	<ul style="list-style-type: none"> <li>➤ Generate data that will help us understand the dynamics of model construction/reconstruction of students.</li> <li>➤ Generate data that will allow us to keep track on the conceptual progression of students as they do different activities in the teaching interview.</li> </ul>	<ul style="list-style-type: none"> <li>➤ Schedule student interviews.</li> <li>➤ Follow IRB Protocol – consent form at the beginning of interview.</li> <li>➤ Follow interview protocol.</li> <li>➤ Collect demographic data from students.</li> <li>➤ Videotape and audiotape the interviews.</li> <li>➤ Keep observation notes.</li> <li>➤ Involve an observer.</li> </ul>

### Overall Research Plan - Continued

Proposed Strategy	Resources	Goals	Methodology Guide Notes
<b>Data Analysis</b>			
Analyze Data	<ul style="list-style-type: none"> <li>➤ Transcripts of Interviews</li> <li>➤ Field Notes</li> </ul>	Make the data more manageable for interpretation.	<ul style="list-style-type: none"> <li>➤ Use a phenomenographic approach.</li> <li>➤ Use thematic analysis</li> </ul>
<b>Report Findings, Implications for Further Research &amp; Applications, Integration into Theoretical Framework</b>			
Compare findings with the findings from other related studies.	<ul style="list-style-type: none"> <li>➤ Findings from Related Studies.</li> <li>➤ Findings of Research.</li> </ul>	Generate Questions for Further Research	Based on the findings of the research and of other related studies try to generate questions that need further investigation.
Report Findings	Results of Data Analysis	Make other researchers aware of our significant findings.	<ul style="list-style-type: none"> <li>➤ Report findings at group meetings.</li> <li>➤ Give talks at PER seminar</li> <li>➤ Meet regularly with advisor</li> <li>➤ Keep committee members informed</li> </ul>

**Research Plan: Phase I Students' Mental Model of Friction at the Atomic Level (Grounded Theory Approach)**

<b>Proposed Strategy</b>	<b>Resources</b>	<b>Outcome</b>	<b>Methodology Note Guides</b>
<b>Development of Clinical Interview Protocol</b>			
<ul style="list-style-type: none"> <li>➤ Review research literature on friction.</li> <li>➤ Talk to physics experts.</li> </ul>	<ul style="list-style-type: none"> <li>➤ Articles written about friction at the atomic level.</li> <li>➤ Physics "Experts"</li> </ul>	Preliminary List of Interview Questions	Pilot test the protocol with students in KSU PERG before doing actual interviews
Pilot Test Preliminary List of Interview Questions	Graduate and undergraduate students	Know which questions are good and which needs to be replace or restated, and the ordering of questions.	Revise the initial list based on the feedback from the pilot testing
<b>Clinical Interview</b>			
Do Clinical Interviews	Introductory College Physics Students at KSU (PWorld, GP 1, GP 2, EP1, EP2, Contemporary Physics Students)	Generate Students' Pre-Existing Mental Models about friction at the atomic level	<ul style="list-style-type: none"> <li>➤ Recruit volunteers.</li> <li>➤ Schedule interviews.</li> <li>➤ Obtain informed consent from students as per IRB protocol.</li> <li>➤ Videotape interviews.</li> <li>➤ Analyze after <i>each</i> episode.</li> </ul>
<b>Analyze Data</b>			
Analyze Clinical Interview Data	<ul style="list-style-type: none"> <li>➤ Transcript of Interviews</li> <li>➤ Videotape of Interviews</li> <li>➤ Observation Notes</li> </ul>	<ul style="list-style-type: none"> <li>➤ Look at the variations in students' ideas.</li> <li>➤ Categorize students' ideas</li> <li>➤ Generate Themes</li> </ul>	<ul style="list-style-type: none"> <li>➤ Digitize the video</li> <li>➤ Transcribe the clinical interviews in full.</li> <li>➤ Use phenomenographic approach to code data.</li> <li>➤ Use thematic approach to generate themes.</li> </ul>

**Research Plan: Phase II – Dynamics of Students’ Model Construction/Reconstruction**

<b>Proposed Strategy</b>	<b>Resources</b>	<b>Outcome</b>	<b>Methodology Note Guides</b>
<b>Establish Target Models</b>			
<ul style="list-style-type: none"> <li>➤ Interview Physics “Experts”</li> <li>➤ Read literatures on friction at the atomic level.</li> </ul>	Articles written about friction at the atomic level	<ul style="list-style-type: none"> <li>➤ Establish the target models for the teaching interviews.</li> <li>➤ Preliminary List of Interview Questions</li> </ul>	<ul style="list-style-type: none"> <li>➤ Prepared a questionnaire (experts’ ideas on atomic friction) and sent it out to experts outside of KSU physics department to answer.</li> <li>➤ Asked experts for further references.</li> </ul>
<b>Development of the Teaching Interview Protocol</b>			
Design activities for the teaching experiment.	Results from Phase 1	Come up with different activities that would provide students cognitive conflict.	<ul style="list-style-type: none"> <li>➤ Solicited suggestions from the person in-charge of setting up laboratory activities for introductory college physics.</li> <li>➤ Brainstorm with research advisor on possible activities.</li> </ul>
Do some pilot interviews	Introductory College Physics Students	<ul style="list-style-type: none"> <li>➤ Assess how students respond to the activities</li> <li>➤ Generate questions to ask students</li> </ul>	Brainstorm with research advisor on alternative activities.
Talk to experts regarding the teaching interview protocol	KSU Physics Professors	Get feedback from expert for improvement of the protocol	Get suggestions from research advisor regarding possible resource persons.

Proposed Strategy	Resources	Outcome	Methodology Note Guides
<b>Conduct Teaching Interviews</b>			
Do Individual Teaching Interviews	Introductory College Physics Students at KSU (P. World, GP 1, GP 2, EP1, EP2, Contemporary Physics Students)	<ul style="list-style-type: none"> <li>➤ Generate data that will help us understand the dynamics of model construction/reconstruction of students.</li> <li>➤ Generate data that will allow us to keep track on the conceptual progression of students as they do different activities in the teaching interview.</li> </ul>	<ul style="list-style-type: none"> <li>➤ Recruit volunteers.</li> <li>➤ Schedule interviews.</li> <li>➤ Obtain informed consent from students as per IRB protocol.</li> <li>➤ Videotape and audiotape the interviews.</li> <li>➤ Keep observation notes.</li> <li>➤ Involve an observer.</li> <li>➤ Employ iterative analysis of the videos.</li> </ul>
Do Group Teaching Interviews	Introductory College Physics Students at KSU (P. World, GP 1, GP 2, EP1, EP2, Contemporary Physics Students)	<ul style="list-style-type: none"> <li>➤ Generate data that will help us understand the dynamics of model construction/reconstruction of students when they work with their peers</li> <li>➤ Generate data that will allow us to keep track on the conceptual progression of students as they do different activities in the teaching interview.</li> </ul>	<ul style="list-style-type: none"> <li>➤ Recruit volunteers.</li> <li>➤ Form groups (homogenous and heterogeneous) taking into account the majors of the students.</li> <li>➤ Schedule interviews</li> <li>➤ Obtain informed consent from students as per IRB protocol.</li> <li>➤ Videotape and audiotape the interviews.</li> <li>➤ Keep observation notes.</li> <li>➤ Involve an observer.</li> <li>➤ Employ iterative analysis of the videos.</li> </ul>



Proposed Strategy	Resources	Outcome	Methodology Note Guides
<b>Analyze Data</b>			
Analyze the Data using different theoretical lenses (conceptual change, transfer)	<ul style="list-style-type: none"> <li>➤ Transcript of Teaching Interview Sessions</li> <li>➤ Observation Notes</li> <li>➤ Students' Worksheets</li> </ul>	<ul style="list-style-type: none"> <li>➤ Look at how students progressed conceptually in the course of the teaching interview.</li> <li>➤ Understand how the different inputs afforded to students affected their model construction/reconstruction.</li> </ul>	<ul style="list-style-type: none"> <li>➤ Use phenomenographic approach to compare students' ideas with the target ideas.</li> <li>➤ Cross check the interpretations out of the transcripts with other members of the research group.</li> </ul>

**Research Plan: Phase III – Development & Pilot Testing of Instructional Activities**

<b>Proposed Strategy</b>	<b>Resources</b>	<b>Outcome</b>	<b>Methodology Note Guides</b>
<b>Develop/Adapt Questionnaire for Content Validation</b>			
<ul style="list-style-type: none"> <li>➤ Talk to experts on curriculum material development</li> <li>➤ Read books/articles on validating instructional materials</li> <li>➤ Review researches on instructional material evaluation</li> </ul>	<ul style="list-style-type: none"> <li>➤ Expert on Curriculum Material Development</li> <li>➤ Physics Teachers</li> <li>➤ Books on Curriculum Material Evaluation</li> </ul>	<p>Have a basis of establishing content validity of the developed material</p>	<p>Generate list of questions for establishing content validity of the instructional material.</p>
<b>Develop Learning/Attitude Assessments</b>			
<ul style="list-style-type: none"> <li>➤ Review the scientific models and target models.</li> <li>➤ Review the results of the teaching interview.</li> </ul>	<ul style="list-style-type: none"> <li>➤ Results from the Teaching Interview</li> <li>➤ Scientific and Target Models</li> </ul>	<ul style="list-style-type: none"> <li>➤ To evaluate learning of students after using the instructional materials.</li> <li>➤ To assess students' attitude towards the instructional material.</li> </ul>	<ul style="list-style-type: none"> <li>➤ Based on the review of the models and results of the teaching interview come up with varied type of questions (i.e. concept maps, multiple-choice, free response, etc.) to assess students' learning.</li> <li>➤ Develop a Likert Scale questionnaire to assess students' attitudes.</li> </ul>

Proposed Strategy	Resources	Outcome	Methodology Note Guides
<b>Content Validation with Experts</b>			
Have experts go through the developed activities and have them content-validate it.	Physics Professors at KSU who have handled introductory college physics classes.	Have a Content- Validated Teaching Material	Revise Material based on Expert's Feedback if necessary
<b>Pilot Test w/ Group of Students</b>			
Conduct group activities with students using the developed instructional material and activities	<ul style="list-style-type: none"> <li>➤ GP1 students</li> <li>➤ PWorld Students</li> </ul>	<ul style="list-style-type: none"> <li>➤ Better know the implementation issues that come up</li> <li>➤ Get feedback from End users</li> </ul>	<ul style="list-style-type: none"> <li>➤ Conduct follow up interview with students to get their feedback.</li> <li>➤ Have students fill out the developed Likert Scale questionnaire.</li> </ul>

Proposed Strategy	Resources	Outcome	Methodology
<b>Analyze Data From the Pilot Test</b>			
<ul style="list-style-type: none"> <li>➤ Go over the videotape of the activities and look for points for improvement and issues of implementation.</li> <li>➤ Listen to the audiotape to sieve through students' suggestions for improvement.</li> </ul>	<ul style="list-style-type: none"> <li>➤ Videotape of Group Activities.</li> <li>➤ Audiotape of the follow up interview with students.</li> <li>➤ Answers to the Questionnaire</li> </ul>	To further improve the instructional material.	<ul style="list-style-type: none"> <li>➤ Generate data for ascertaining the effectiveness of the material in attaining its goal/s.</li> <li>➤ Generate list of implementation issues that need to be considered during the field testing.</li> </ul>
<b>Finalize Instructional Package</b>			
Prepare the instructional package in its final form.	Results from the Pilot Test	Create an instructional package ready for use in real class setting.	<ul style="list-style-type: none"> <li>➤ Revise the instructional material based on student's feedback from the pilot test.</li> <li>➤ Write an instructor's guide for better implementation.</li> </ul>

# Appendix F - Informed Consent Form

## KANSAS STATE UNIVERSITY

### INFORMED CONSENT TEMPLATE

PROJECT TITLE:	Research on Students' Mental Models, Learning and Transfer as a Guide to Application Based Curriculum Development and Instruction in Physics
PRINCIPAL INVESTIGATOR: CO-INVESTIGATOR(S):	N. Sanjay Rebello (PI) Peter Fletcher (co-PI) Edgar G. Corpuz (Co-Investigator)
CONTACT AND PHONE FOR ANY PROBLEMS/QUESTIONS:	N. Sanjay Rebello srebello@phys.ksu.edu (785) 532 1612
IRB CHAIR CONTACT/PHONE INFORMATION:	Clive Fullagar, Chair of Committee on Research involving Human Subjects 1 Fairchild Kansas State University, Manhattan KS, 66506, (785) 532-3224  Jerry Jaax, Associate Vice Provost for Research Compliance 1 Fairchild Kansas State University, Manhattan KS, 66506, (785) 532-3224
SPONSOR OF PROJECT:	National Science Foundation
PURPOSE OF THE RESEARCH:	1.To investigate students' understanding of conceptions in physics, and how it depends upon the context (situation) in which it is presented, especially contexts related to real-world applications of physics. 2.Develop instrument(s) that can be used by others to trace development of their students' understanding in physics over a semester (or longer).
PROCEDURES OR METHODS TO BE USED:	Interviews, written open-ended and multiple choice questions
ALTERNATIVE PROCEDURES OR TREATMENTS, IF ANY, THAT MIGHT BE ADVANTAGEOUS TO SUBJECT:	None
LENGTH OF STUDY:	2 meetings of one hour each
RISKS ANTICIPATED:	No known risks
BENEFITS ANTICIPATED:	Deeper understanding of physical phenomena
CONFIDENTIALITY:	The student's performance and/or statements during interview and in survey will not be disclosed with students' name or any identifying feature.
PARENTAL APPROVAL FOR MINORS:	Not Applicable
PARTICIPATION:	Voluntary

**I understand this project is for research and that my participation is completely voluntary, and that if I decide to participate in this study, I may withdraw my consent at any time, and stop participating at any time without explanation, penalty, or loss of benefits, or academic standing to which I may otherwise be entitled.**

**I also understand that my signature below indicates that I have read this consent form and willingly agree to participate in this study under the terms described, and that my signature acknowledges that I have received a signed and dated copy of this consent form.**

**Participant Name:** \_\_\_\_\_

**Participant Signature:** \_\_\_\_\_ **Date:** \_\_\_\_\_

**Witness to Signature: (project staff)** \_\_\_\_\_ **Date:** \_\_\_\_\_

## Appendix G - Questionnaire for Experts

### Experts' Present Ideas of Friction

Purpose:

The purpose of this questionnaire is to establish the present ideas of experts in explaining friction and some related phenomena at the atomic level. Your ideas will provide us basis in designing teaching experiments aimed at helping students build expert-like models of friction at the atomic level.

Name of Expert: \_\_\_\_\_

University/Company/Institution: \_\_\_\_\_

Do you give permission to have your name mentioned in the research paper as one of the experts?

YES                       NO.

**Part I:** *Please answer the questions below keeping in mind that we are basically interested in knowing how you would explain to yourself friction and some related phenomena.*

**Question 1:** What would a rough surface and a smooth surface look like at the atomic level? Please sketch how the atoms on the outermost surface are arranged.

Answer:

**Question 2:** What would the smoothest possible surface look like at the atomic level?

Answer:

**Question 3:** Please explain how friction is produced on the atomic level when two surfaces come into contact and slide past one another.

Answer:

**Question 4:** Why based on an explanation at the atomic level is kinetic friction smaller than static friction?

**Answer: Question 5:** What happens to the friction force between two surfaces when we make the surfaces smoother and smoother? What happens to the friction force when we make two surfaces perfectly smooth?

Answer:

**Question 6:** Please sketch below the graph of how friction force varies with surface roughness. Please explain the details of your graph. What factors come into play in different regions of your graph?

Answer:

**Question 7:** Could you please write down a mathematical expression for the friction force that can somehow explain your graph?

Answer:

**Question 8:** How does a lubricant (e.g., oil) reduce friction? What is happening between two surfaces with lubricant between them at the atomic level?

Answer:

**Part II: Based on your answers to the questions above, what model/s would you use to explain friction and lubrication at the microscopic level to introductory college physics students?**

Thank you very much for your time and effort in answering the above questions!



## Appendix H - The Five-Minute Paper

**Direction:** Please answer the following questions in as much detail as you can.

What new ideas regarding friction did you learn in the interviews?

---

---

---

---

---

---

---

Please write down your comments about the activities.

---

---

---

---

How did the activities help you learn?

---

---

---

---

---

What changes do you suggest for the activities to make you better learn?

---

---

---

---

---

---

Thanks a lot!

## Appendix I - Demographics of Teaching Interview Participants

### Individual Teaching Interview Volunteers

INDIVIDUAL TEACHING INTERVIEWS ( Summer & Spring 2003 )			
STUDENT	PHYSICS COURSE	MAJOR	HIGH SCHOOL PHYSICS
P01 (F)	Physical. World	English & Psychology	Yes
P02 (F)	Physical. World	Interior Design	No
G11 (F)	General Physics 1	Biology	Yes
G12 (M)	General Physics 1	Open	Yes
G13 (F)	General Physics 1	Kinesiology	No
G14 (M)	General Physics 1	Open	Yes
G21 (F)	General Physics 2	Nutrition & Exercise Sciences	Yes
G22 (M)	General Physics 2	Biology	Yes
G23 (F)	General Physics 2	Biochemistry	No
G24 (F)	General Physics 2	Biology	Yes
INDIVIDUAL TEACHING INTERVIEWS ( Fall 2004)			
E11 (M)	Engineering Physics 1	Civil Engineering	Yes
E14 (M)	Engineering Physics 1	Electrical Engineer	Yes
E12 (M)	Engineering Physics 1	Civil Engineering	No
E13 (M)	Engineering Physics 1	Chemical Engineering	Yes
E21 (M)	Engineering Physics 2	Mechanical Engineering	Yes
E22 (M)	Engineering Physics 2	Mechanical Engineering	Yes
E23 (M)	Engineering Physics 2	Mechanical Engineering	Yes
E24 (F)	Engineering Physics 2	Electrical Engineering	Yes

### Group Teaching Interview Volunteers

GROUP TEACHING INTERVIEWS			
Name*	Physics Course	Major	HS Physics
Gerald	Engineering Physics 1	Mechanical Engineering	Yes
Matt		Chemistry	Yes
Arthur	Engineering Physics 2	Electrical Engineering	Yes
Nathan		Mechanical Engineering	Yes
Tony	Engineering Physics 1	Electrical Engineering	Yes
John		Electrical Engineering	Yes
Ron		Mechanical Engineering	Yes
Lynn	Engineering Physics 2	Chemistry	Yes
Jeff		Mechanical Engineering	Yes
Meg		Mechanical Engineering	Yes

\* Not their real names.

## Appendix J - Sample Transcript

FEELING & SKETCHING OF SURFACES	
Significant Statements	Associations
<p><i>If you are to sketch a certain portion of this (wood block) and a certain portion of the sandpaper at the level where you see the atoms, how would the atoms of the surface be arranged?</i></p> <p>For the wooden block it will be arranged like this &lt;makes sketch 5&gt;. It will be more uniform as the sandpaper would be &lt;makes sketch 6&gt;</p> <p>The &lt;points to sketch 5&gt; wooden block would have the same, since it is smoother the atoms would be arranged in a better manner than the sandpaper were, because it is rougher. It will be more disorganized.</p>	<pre> graph TD     WB(Wooden Block) &lt;--&gt; S(Smoother)     S &lt;--&gt; UA(Uniform Arrangement of Atoms)     Sandpaper &lt;--&gt; RS(Rougher Surface)     RS &lt;--&gt; DA(Disorganized Arrangement of Atoms)         </pre>
<p><i>Could you please elaborate more about the atoms in your wooden block?</i></p> <p>The atoms would be the same kind. And for the sandpaper, it is made up of different materials and so it will be of different sizes and it wouldn't be as uniform.</p>	<pre> graph TD     WB(Wooden Block) --&gt; SKA(Same Kind of Atoms)     Sandpaper --&gt; CDM(Consists of Different Materials)     CDM --&gt; DSA(Different Sizes of Atoms)         </pre>
<p><i>What do you mean by atoms?</i></p> <p>&lt;makes sketch 7&gt; you have your protons and neutrons depending on the material and you have different numbers of these. And then these would be surrounded by clouds of electrons.</p>	<pre> graph TD     Atoms --&gt; Protons     Atoms --&gt; Neutrons     Atoms --&gt; CE(Cloud of Electrons)         </pre>

**PULLING OF BLOCK ACROSS THE SANDPAPER**

*What do you think happens to the reading on the spring scale as we try to drag the wooden block across the wooden plank?*

It will go up to a certain point and then as the block moves it will drop down to another point because of the static friction will be higher than the kinetic friction.

*What's the reason for your prediction?*

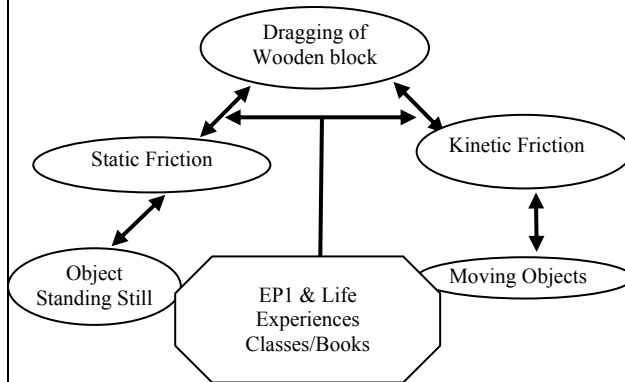
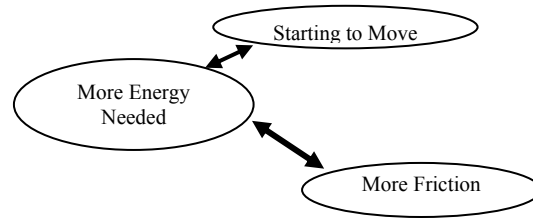
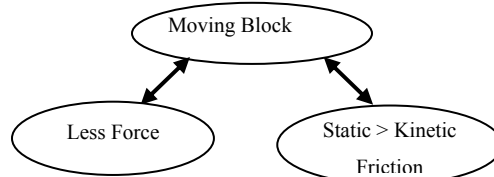
That there is friction between the block and the plank and to get the block moving it requires more energy than to keep it moving once its, cause static friction is greater than kinetic which is when it is moving.

*What is static and kinetic friction to you?*

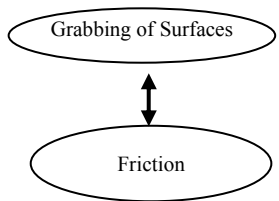
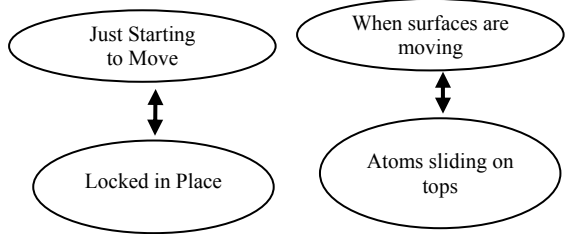
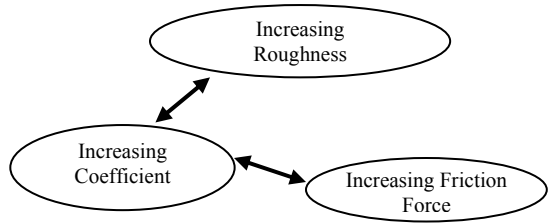
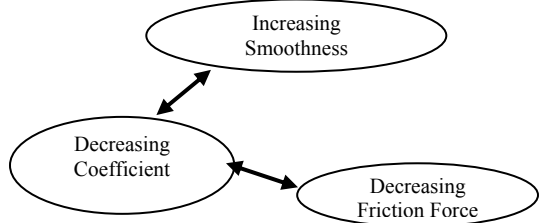
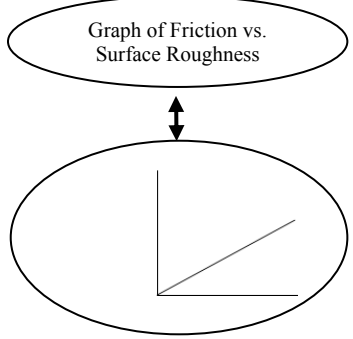
Static is when it is standing still and kinetic is when it's in motion.

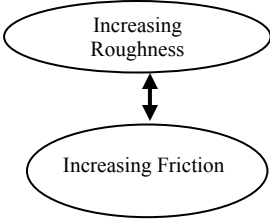
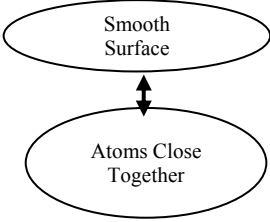
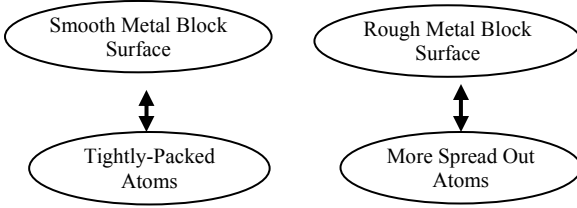
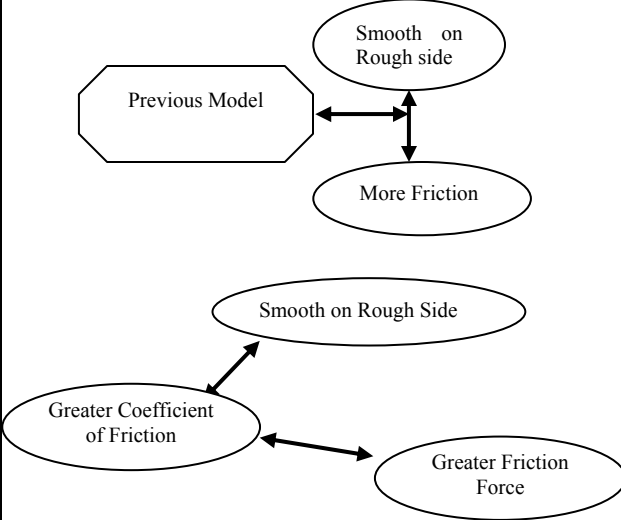
*Where are you basing your predictions?*

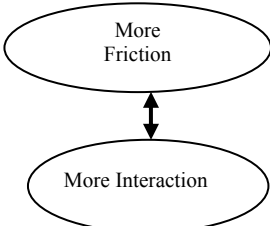
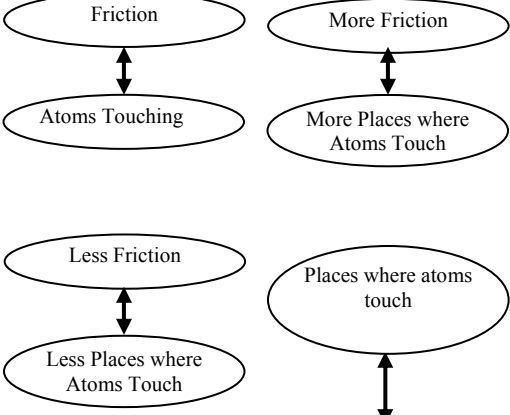
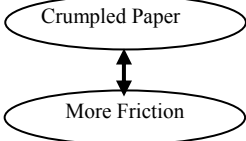
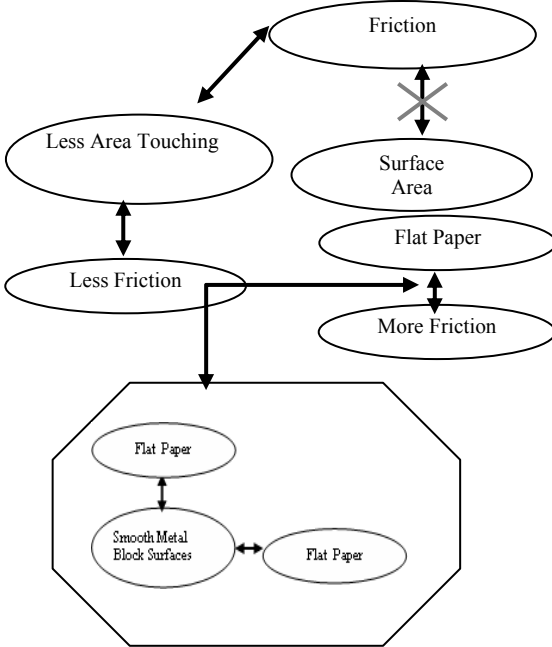
That is what we learned in EP 1 and also just knowledge from life experiences. Like sliding, trying to load something into a truck, and when you are sliding it up on a ramp. Depending on the surface of the ramp is how easy or how hard it is to push it up...



<p>What is causing the friction between the two surfaces?</p> <p>Just the arrangement of the atoms. And also due to the weight of the other atoms on top pushing together. And so there is a force pushing down on the wood plank and the wood also pushing back with the same force...that is causing the friction.</p>	<pre> graph TD     A(Cause of Friction) --&gt; B(Arrangement of Atoms)     A --&gt; C(Force Pushing)     C --&gt; D(Weight)   </pre>
<p>Could you please talk about the interactions of the surfaces when you are just starting it to move and when it is already moving?</p> <p>Well this (sketch 6) is just before it is moving. Since the atoms are in circles and they are probably arranged like this &lt;makes sketch 9&gt; So the one of these (atoms) of the block it's on the valley of the planks but then when it starts to move they kind of glide &lt;makes sketch 10&gt; , they just run along on the tops of the atoms and they don't drop down into the valleys.</p> <p>What will that do the friction force?</p> <p>It will make the friction less, because it is just touching on the tops instead of the whole thing.</p>	<pre> graph TD     A(Before Motion Starts) &lt;--&gt; B(Atoms of One Surface drops down on the valleys)     B --&gt; C(Surfaces Moving over the other)     C &lt;--&gt; D(Atoms run along on the tops)     D --&gt; E(Less Friction)   </pre>
<p>If we do the same thing over here (sandpaper) could you please predict what would happen to the force?</p> <p>Static friction would be higher because the surface is rougher. But it will have the same effect that once it starts to move there will be less force needed.</p>	<pre> graph TD     A(Rougher Surface) --&gt; B(More Static Friction)     A --&gt; C(More Kinetic Friction)   </pre>
<p>Could you please sketch how the interacting surfaces would look like at the level where you see the atoms.</p> <p>&lt;makes sketch 11&gt; This is for the sandpaper (lower portion of sketch 11) and since it has smaller sizes it's more rougher the block's atoms fit down into it more than they do on the smooth surface. So it creates more friction.</p>	<pre> graph TD     A(Sandpaper) &lt;--&gt; B(Smaller-sized atoms compared to Wood Block)     B --&gt; C(Atoms Fit More)     C --&gt; D(More Friction)   </pre>

<p><i>So what is causing the increase in friction?</i></p> <p>Over here (block over the wood plank) it is smooth, the surfaces are all just the same but on here (block over the sandpaper) there's edges that actually that grab on to the block and create the friction.</p>	
<p><i>In terms of the interaction of the surfaces, what is happening?</i></p> <p>When you are starting to move they are locked in place. But then as they start to move &lt;makes sketch &gt; they just slide along the tops of the atoms, so it can't create as much friction.</p>	
<p><i>If we make the surfaces rougher and rougher, what do you think would happen to the force?</i></p> <p>The friction force will get greater because the static coefficient of friction will become greater because of the roughness.</p>	
<p><i>How about if we make the surfaces smoother and smoother?</i></p> <p>The force needed would be less and less because the coefficient of friction would be small.</p>	
<p><i>Could you please make a graph on how the friction force varies with the roughness of the surfaces?</i></p> <p>&lt;makes sketch 13&gt; This &lt;points to the vertical axis&gt; is the friction between the surfaces. If it is smooth then it is less than when it goes to rough.</p>	

<p>Could you please talk a bit more about this region here (right side of the graph)? Will it keep going up?</p> <p>Yeah, it will keep going up because the surfaces can get rougher and there's no actual limit on how rough they can get.</p>	
<p>How would you sketch the pair of surfaces at the level where you see the atoms?</p> <p>At this extreme (left side of graph) they'd just be &lt;makes sketch 17&gt;. The atoms would be close together just so that there's not much space between them where the other's atoms would fall in between.</p>	
<p><b>METAL BLOCKS ACTIVITY</b></p>	
<p>Please make a sketch on how the surfaces would look like to you at that level (atomic)?</p> <p>This is for the top &lt;makes sketch 19&gt;. This would be tightly packed together, with not much space in between. And then for the sides it will be a little bit more spread out &lt;makes sketch 20&gt;</p>	
<p>If we are to slide this (slider) surface across the smooth and rough side of the rectangular block</p> <p>There will be more friction on the rough side instead of the smooth side.</p> <p>And why do you think that is?</p> <p>Because the coefficient of friction is greater on the rougher side than the two smooth sides.</p> <p>Are you basing your prediction to what we did earlier with wooden block?</p> <p>Yeah.</p>	

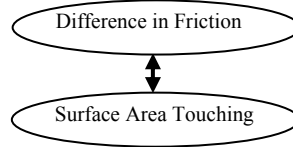
<p><i>Was that what you expected?</i></p> <p>No. I'm guessing that the surface feels smooth but it's just interacting with the other surface creating more friction than the other surface together.</p>	
<p><i>Could you please make a sketch on how the interacting surfaces would look like?</i></p> <p>&lt;makes sketches 21 and 22&gt; This (sketch 21) would be for the smooth block and the smooth part of the other block. And this (sketch 22) is the smooth block and the rough block. The reason that there's actually more friction on this one (sketch 21) is that there's more places where the atoms are touching and creates more friction. Whereas on this (sketch 22) one there's less points of interaction.</p>	
<p><b>PAPER-TRANSPARENCY ACTIVITY</b></p>	
<p><i>If we are to slide these two sheets of paper one after the other across the transparency, which one will create more friction?</i></p> <p>This one (crumpled paper) will have more friction.</p>	
<p><i>Why do you believe that?</i></p> <p>Cause it's rougher but actually no, it would be this one because it is just like the two blocks where they are both smooth so they'll create sort of vacuum together kind of. Whereas on this one there'll be areas touching so there'll be less friction.</p> <p><i>Where are you basing your predictions?</i></p> <p>Just because it's like the two metal blocks that we just used. Where on the smooth side on the smooth side creates more friction.</p>	



**EXPLANATION OF PAPER-TRANSPARENCY OBSERVATION**

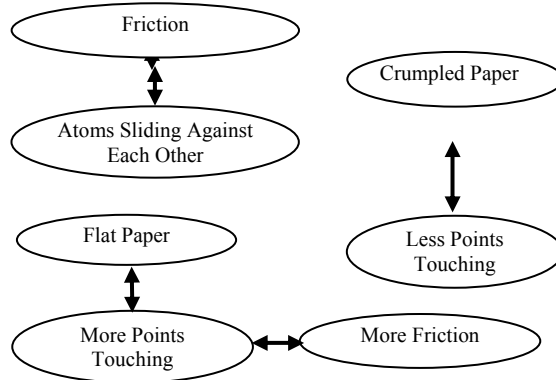
*Why do you think that there's more friction on that case?*

Just that there is more surface area that is actually touching the transparency than this (crumpled) one.



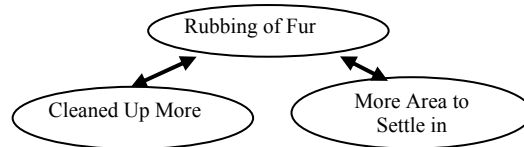
*What is causing the friction between these two (flat paper and transparency) surfaces here?*

The edges of the paper touching the transparency, the atoms sliding against each other. On this one (flat) it's touching on all the points so there's more friction. Where here (crumpled) there's less points where it is touching.



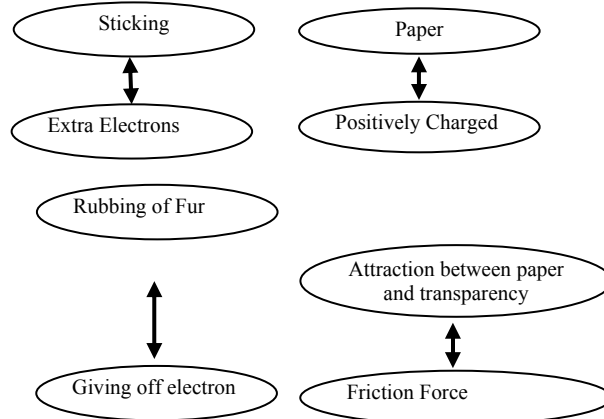
*What do you think would happen to the force if rub the transparency more with the fur?*

There will be more friction because it will be cleaned up more and there will be more area where this will settle in.

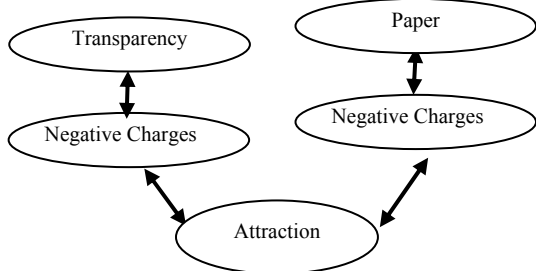


<interviewer brings the transparency rubbed with fur near the arms of the student>

I felt a little. There's electro negative. It's just that there's a different charge here so that can actually be another. It got extra electrons so that could be another reason why it holds on to the paper. Because the paper is positively charged and this (transparency) can be negatively charged because we rubbed it with fur and gave it electrons and that would create an attraction between the transparency and the paper and that would add to the friction force.



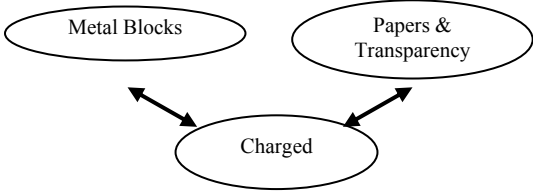
Since there are different charges, this one is negative (transparency) and this is positively charge and when they are close together the atoms can create an attraction to keep them together.



**RELATING METAL BLOCK WITH PAPER & TRANSPARENCY ACTIVITIES**

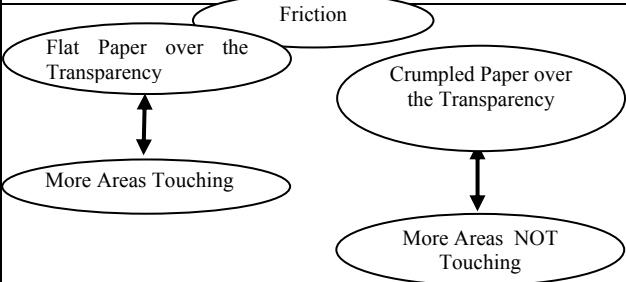
*How would you relate that to the metal blocks?*

Like on the blocks they could have if one is positively charged that would also create a friction between them just like the transparency and the paper.



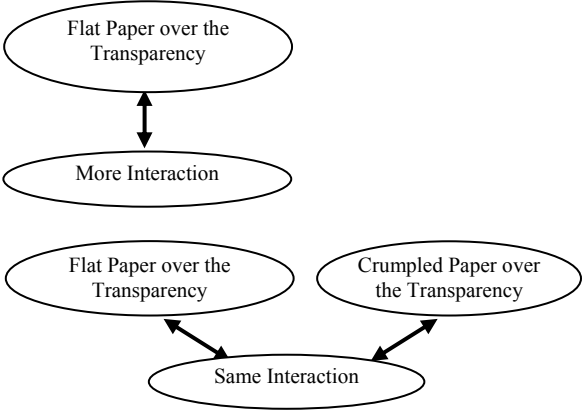
*In these two cases (paper and transparency), how would the surface touching compare?*

On this one (flat paper) they are touching a lot more than on this one (crumpled) since it is crumpled there's more areas where they are not touching.



*So in which case do you more of this (attraction) interaction?*

On this one (flat) there's more of this interaction because they are closer. Well there's the same interaction but on this one (flat) it is more evident because they are closer so this force (attractive) can be more powerful.

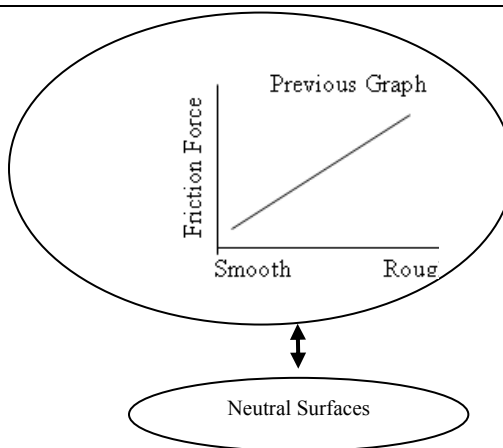


<p>How would you relate that to what you observed on the metal blocks?</p> <p>Just that on the two smooth metals if one is positive and the other is negative, that will create an attraction which will increase the friction between them. And then on the rough one, they would be of the same charge and that would create a repulsion that would push them away slightly so there would be less friction.</p> <p>=</p>	<p>The diagram consists of several ovals connected by arrows. At the top, 'Positive Charges' and 'Negative Charges' are connected by double-headed arrows to a central 'Attraction' oval. Below 'Attraction' is 'Increased in Friction', connected by a double-headed arrow. To the left, 'Rough Surface' is connected by a double-headed arrow to 'Same Charges'. 'Same Charges' is connected by a double-headed arrow to 'Repulsion'. 'Repulsion' is connected by a double-headed arrow to 'Less Friction' at the bottom.</p>
<p>You said earlier here that the interactions are the same but there are just fewer on this (crumpled paper). So what is your basis in thinking that for this (sketch 22) both are positive or both are negative?</p> <p>Actually yeah, that they can be both positive and negative but this one (sketch 22) there's only like three attraction which would be less than the attraction here (sketch 21) like four to four.</p>	<p>The diagram shows 'Rough Surfaces' at the top. Below it, 'Same Charge' and 'Less Attraction' are shown. A double-headed arrow connects 'Same Charge' and 'Less Attraction', but it is crossed out with a large 'X'. A single-headed arrow points from 'Rough Surfaces' down to 'Less Attraction'.</p>
<p>What do you think can we do to increase this (attraction) the number of interacting atoms.</p> <p>You can probably make the surface smoother or get denser material.</p>	<p>The diagram shows two parallel paths. On the left, 'Increasing Smoothness' is connected by a double-headed arrow to 'Increasing Attraction'. On the right, 'Increasing Density of Material' is connected by a double-headed arrow to 'Increasing Attraction'.</p>

**MODIFYING GRAPH OF FRICTION VERSUS ROUGHNESS**

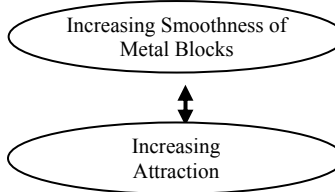
Going back to your graph over there do you still go with it?

Well this is if there's no electric charges like if both particles are neutral then this holds true. But if they are of the same charge or opposite charges the graph would be different.



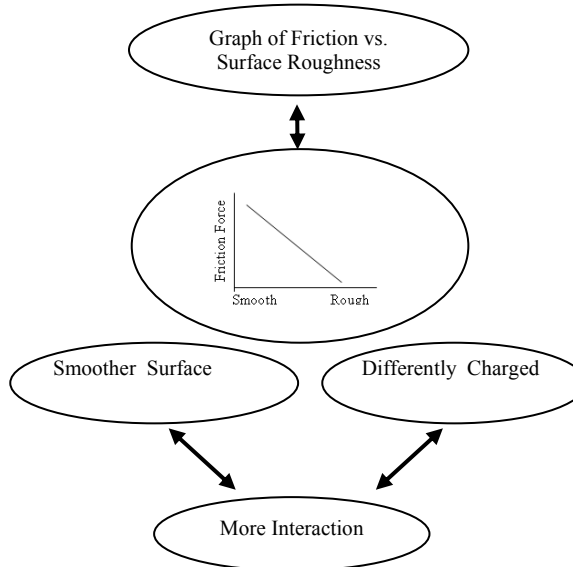
For differently charged surfaces what would your graph of friction be? What do you think would happen to the friction if we make these (metal blocks) smoother and smoother?

It will increase.



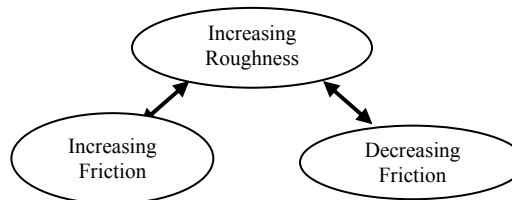
What would your graph be for this material?

<makes sketch 26> It will be more like this. If they are differently charged then the smoother they are the more interactions.



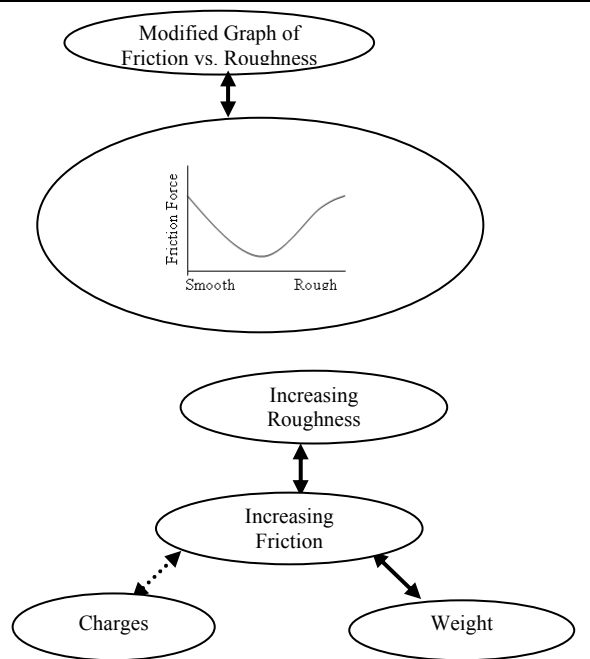
How about if we make these rougher and rougher, what do you think would happen to the friction force? If we can make them as rough or maybe even rougher than the sandpaper.

It will get less but then it will also increase because of the charges can only create so much attraction between the surfaces.



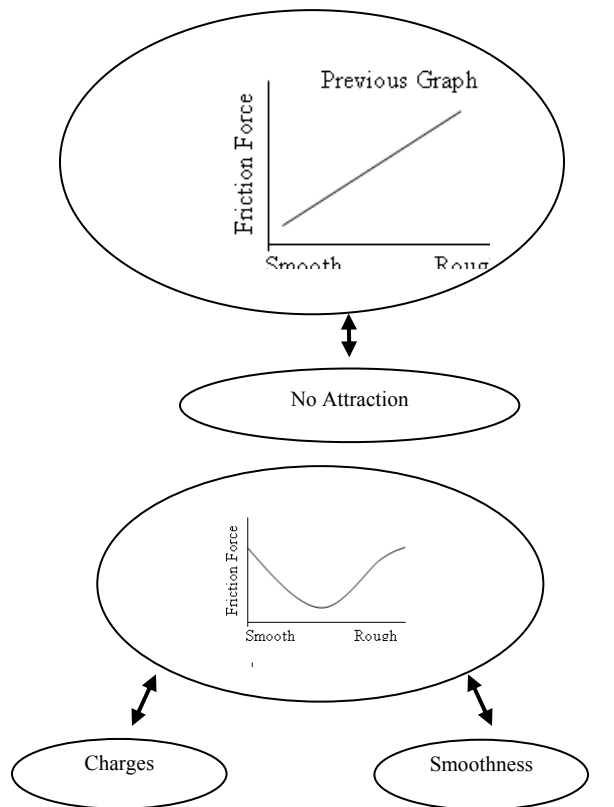
How would you incorporate that in your graph?

<makes sketch 27> it would be high and then as it gets rough there will be a point where the charges are overwhelmed by the actual weight of the object and then the friction will increase again.



What do you feel about the graph that you just came up with? Does that make more sense to you than the graph you made earlier?

Well this one here (sketch 25) depends on the charges along with the smoothness of the object. The one that I made earlier was just with objects that aren't fully charged and there wouldn't be any attraction.



# **Appendix K - Version of the Instructional Material for Content Validation**

## **Cover Letter**

Dear Expert,

As a part of my doctoral research, I am currently developing and validating an instructional material entitled "When Things Get Rough". This material aims to help introductory physics students develop a better model of friction at the atomic level. I know that with your strong research and teaching background you could provide me helpful feedback on the developed material. In this regard, could you please critique the said instructional material in terms of the physics content, activities and assessment task by answering the questionnaires attached to this packet?

Rest assured that your help will be properly acknowledged on my paper. Thanks a lot for your time and help.

Truly yours,

Edgar G. Corpuz  
Graduate Student  
Physics Department  
Kansas State University

**Name:** \_\_\_\_\_

**Field of Research:**\_\_\_\_\_

**Number of Semesters You Have Taught Introductory Physics Courses:**

**Engineering Physics** \_\_\_\_\_

**General Physics** \_\_\_\_\_

**Physical World** \_\_\_\_\_

=====

**Direction**

*In the proceeding pages, the left hand page contains the material to be critiqued. The right-hand side contains a space where you can write down your specific comments and suggestions. A description and purpose of the activity on the left hand page is also provided. You might find these useful in making your comments and suggestions.*

## Details of the Instructional Material

**Title:** When Things Get Rough

### Learning Goal:

After doing the activities students are expected to have a better understanding of friction at the microscopic level.

**Learning Objectives:** After going through the activities students are expected to be able to:

- Identify the different factors that come into play when talking about friction at the atomic level.
- Discuss how each of the different factors affects friction.
- Apply the mathematical model ( $\mu N + cA$ ) in explaining friction in different situations and contexts.
- Realize that friction at the macroscopic level is different from microscopic friction.

### Target Ideas:

- At the atomic level, friction is due to electrical interactions between atoms.
- Friction is dependent on the atomic contact area.
- Friction varies with surface roughness as in the figure 1.
- Friction on atomically smooth surfaces can be large.
- Atomic friction is described mathematically by equation 1.



Figure 1. Variation of Friction with Roughness

$$f = \mu N + cA \quad [1]$$



**Target Students:** Introductory College Physics Students (Physical World, General Physics and Engineering Physics Students)

## 'Details of the Instructional Material

**Title:** When Things Get Rough

### Learning Goal:

After doing the activities students are expected to have a better understanding of friction at the microscopic level.

**Learning Objectives:** After going through the activities students are expected to be able to:

- Identify the different factors that come into play when talking about friction at the atomic level.
- Discuss how each of the different factors affects friction.
- Apply the mathematical model ( $\mu N + cA$ ) in explaining friction in different situations and contexts.
- Realize that friction at the macroscopic level is different from microscopic friction.

### Target Ideas:

- At the atomic level, friction is due to electrical interactions between atoms.
- Friction is dependent on the atomic contact area.
- Friction varies with surface roughness as in the figure 1.
- Friction on atomically smooth surfaces can be large.
- Atomic friction is described mathematically by equation 1.

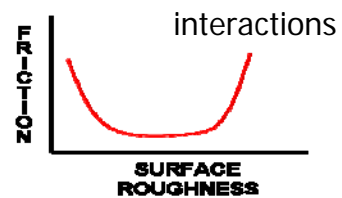


Figure 1. Variation of Friction with Roughness



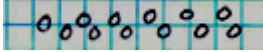
$$f = \mu N + cA \quad [1]$$

**Target Students:** Introductory College Physics Students (Physical World, General Physics and Engineering Physics Students)

COMMENTS	DETAILS OF THE INSTRUCTIONAL MATERIAL
	<p>Description:</p> <p>This part provides a brief learning goals and objectives as well as the target ideas and target students.</p>

COMMENTS	INTRODUCTION
	<p data-bbox="818 344 976 380">Description:</p> <p data-bbox="818 417 1339 489">This part provides a brief introduction about the instructional material.</p>

COMMENTS	ACTIVITY 1
	<p data-bbox="829 268 1338 338">1.1 Listing Existing Ideas About Friction</p> <p data-bbox="829 380 1338 558">Description of the Activity: In this activity students list down their prior ideas about friction based on their everyday experiences and science courses taken.</p> <p data-bbox="829 636 1338 779">Purpose of the Activity: The purpose of the activity is to establish students' current ideas of friction before doing the activities.</p>
	<p data-bbox="829 894 1338 963">1.2 Feeling and Sketching of Different Surfaces</p> <p data-bbox="829 1041 1338 1329">Description of the Activity: In this activity students are asked to slide their fingers across two wooden block surfaces (one is rougher than the other) and a sandpaper surface. They were then asked to sketch how the surfaces would look to them at the level where they see the atoms.</p> <p data-bbox="829 1407 1338 1766">Purpose of the Activity: The purpose of this activity is to activate students' ideas about how rough and surfaces look to them at the atomic level. This is also a way of activating their previous knowledge about atoms and it is hoped that they will use these knowledge in explaining the interaction of two surfaces that move past one another.</p>

COMMENTS	ACTIVITY 1
	<p data-bbox="755 268 1338 338">1.3 Dragging of Wooden Block across Sandpaper and Wooden Surface</p> <p data-bbox="755 380 1338 558">Description of Activity: Here students explore how friction varies with the surface roughness of materials by dragging a wooden block across a wooden surface and a surface with sandpaper.</p>  <p data-bbox="755 863 1338 1077">Purpose of the Activity: This activity provides a context in which students apply their previous ideas about friction. This activity provides a context in which students see how friction behaves at the macroscopic level.</p>
	<p data-bbox="755 1121 1338 1190">1.4 Sketching of Pair of Sliding Surfaces at the Atomic level</p> <p data-bbox="755 1194 1338 1335">Description of the Activity: Students are asked to sketch (1-D sketch) how the pair of sliding surfaces would look to them at the level where they see the atoms.</p>  <p data-bbox="818 1415 1273 1446"><i>Typical Sketch of a Smooth Surface</i></p>  <p data-bbox="818 1520 1273 1551"><i>Typical Sketch of a Rough Surface</i></p> <p data-bbox="755 1598 1338 1812">Purpose of the Activity: This activity activates students' current ideas of friction at the atomic level. The sketches are used by students in making sense of what is happening when two surfaces move across each other.</p>

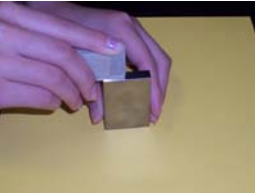
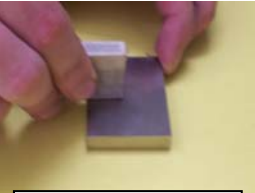
COMMENTS	ACTIVITY 1
	<p data-bbox="873 268 1437 338">1.5 Making a graph of friction vs. surface roughness</p> <p data-bbox="873 380 1227 415">Description of the Activity:</p> <p data-bbox="873 453 1437 594">Here students are asked to make a sketch on how friction varies with surface roughness of the materials that move past one another.</p> <div data-bbox="1073 632 1330 810" data-label="Figure"> </div> <p data-bbox="889 821 1414 856"><i>Typical Graph of Friction vs. Roughness</i></p> <p data-bbox="873 961 1190 997">Purpose of the Activity:</p> <p data-bbox="873 1003 1437 1178">This activity provides another context in which students' initial ideas of friction are being activated. This also provides a means of exploring further into the current ideas of students about friction.</p>

COMMENTS	ACTIVITY 1
	<p data-bbox="889 268 1365 300">1.6 Coming up with Consensus Ideas</p> <p data-bbox="889 380 1045 411">Description:</p> <p data-bbox="889 417 1430 590">In this part of the activity, students are deliberately asked to talk to their group members and come up with a consensus idea about the cause of friction and the factors that would affect friction.</p>
	<p data-bbox="889 1003 1214 1035">1.7 Writing of Own Ideas</p> <p data-bbox="889 1077 1240 1108">Description of the Activity:</p> <p data-bbox="889 1150 1430 1220">Students list down their own ideas about friction.</p> <p data-bbox="889 1335 1000 1367">Purpose:</p> <p data-bbox="889 1444 1430 1514">To establish individual student's current ideas of friction.</p>

COMMENTS	ACTIVITY 1
----------	------------

	<p>1.8 Concept Introduction</p> <p>Description of the Activity: In this part the concept that for macroscopic roughness friction is given by</p> $\text{Friction} = \mu N$ <p>Purpose of the Activity: This provides an additional scaffolding activity that is needed for students to proceed further in reconstructing their ideas of friction.</p>
COMMENTS	ACTIVITY 2
	<p>2.1 Sliding fingernails across surfaces (one rough one smooth) of metal gage blocks</p> <p>Description of the Activity: Students are asked to slide their fingernails across different surfaces of metal gage blocks(one smooth and one rough).</p> <p>Purpose of the Activity: The purpose of the activity is to have students identify which surface is rougher or smoother to them based on their sense of touch.</p>



COMMENTS	ACTIVITY 2
	<p>2.2 Sketching of Pair of Surfaces at the Atomic Level</p> <p>Description of the Activity: Students are again deliberately asked to sketch how the pairs of sliding surfaces would look to them at the level where they see the atoms.</p> <p>Purpose of the Activity: This activity provide context in which students can based their explanations of friction at the atomic level.</p>
	<p>2.3 Sliding metal surfaces across each other</p> <div style="display: flex; justify-content: space-around;"> <div style="text-align: center;">  <p><b>Smooth vs. Smooth</b></p> </div> <div style="text-align: left;"> <p><b>Description:</b> Here students predict in which pair of surfaces (smooth vs. smooth or smooth vs. rough) would be easier to drag across each other and tested their predictions which would show that friction will be greater between the smooth surfaces.</p> </div> </div> <div style="display: flex; justify-content: space-around; margin-top: 20px;"> <div style="text-align: center;">  <p><b>Smooth vs. Rough</b></p> </div> <div style="text-align: left;"> <p><b>Purpose:</b> This activity engages students in cognitive conflict which they try to resolve by doing other activities. Through this activity students' current ideas are being challenged. This put the students in a mode of reconsidering alternative explanations of friction at the atomic level.</p> </div> </div>

COMMENTS	ACTIVITY 2
	<p data-bbox="885 268 1419 338">2.4 Sketching of Pairs of Sliding Surfaces at the Atomic Level</p> <p data-bbox="885 415 1419 741">Description of the Activity: Students make a sketch of the pair of sliding surfaces at the level where they see the atoms. The sketches that they make here is still similar to what they would have sketched previously (i.e. smooth is represented with atoms lining up and rough is represented with atoms in a wavy pattern)</p> <p data-bbox="885 819 1419 995">Purpose of the Activity: This provides another context in which students are given opportunity to reconsider alternative explanations about friction at the atomic level.</p>

COMMENTS	ACTIVITY 3
	<p data-bbox="885 1150 1419 1255">3.1 Pulling of flat paper across a transparency before and after rubbing the transparency with fur</p> <p data-bbox="885 1297 1419 1549">Description of the Activity: Here students are asked to pull a flat paper before and after students rub the transparency with fur. Students find out that it is harder to pull the flat sheet of paper when the transparency is rubbed with fur.</p> <p data-bbox="885 1591 1419 1696">Purpose of the Activity: This is activity to provide a clue on the electrical origin of friction.</p>

COMMENTS	ACTIVITY 3
	<p data-bbox="886 310 1430 373">3.2 Pulling of Flat and Crumpled Paper Across the Transparency Rubbed with Fur</p> <p data-bbox="886 422 1235 449">Description of the Activity:</p> <p data-bbox="886 491 1430 737">Students compare the force needed to pull a flat sheet of paper across the transparency rubbed with fur with the force needed to pull a crumpled sheet of paper across the same transparency. Student find out that it is harder to pull the flat sheet of paper.</p> <p data-bbox="886 821 1187 848">Purpose of the Activity:</p> <p data-bbox="886 890 1430 1100">This activity is used to resolve the cognitive conflict brought about by the metal gage block activity. Through this activity students are provided clue to the role of electrical interactions and the real area of contact between two surfaces.</p>

COMMENTS	ACTIVITY 3
	<p data-bbox="886 233 1430 300">3.3 Sketching of pairs of Sliding surfaces at the Atomic Level</p> <p data-bbox="886 342 1430 558">Description of the Activity: Here students sketch how the pairs of sliding surfaces (flat sheet of paper over the transparency and crumpled sheet of paper over the transparency) would look to them at the atomic level.</p> <p data-bbox="886 600 1430 961">Purpose of the Activity: This activity help student reconsider their previous explanations about friction at the atomic level. This activity provide them another context in which they resolve the conflict in the metal gage block activity. By using their sketches of the metal block surfaces and the paper and transparency student realize how the real area of contact is coming into play.</p>
	<p data-bbox="886 1073 1430 1140">3.4 Relating the Paper &amp; Transparency with the Metal Gage Blocks Activity</p> <p data-bbox="886 1182 1430 1325">Description of the Activity: Students are asked deliberately to relate the paper and transparency activity with the metal block activity.</p> <p data-bbox="886 1409 1430 1654">Purpose of the Activity: Through this activity, students come to realize that friction can be large when surfaces become smooth because the real area of contact increases. Also the electrical interactions between the surfaces become more pronounced.</p>


COMMENTS	ACTIVITY 3
	<p>3.5 Revisit Graph of Friction vs. Surface Roughness</p> <p>Description of the Activity: Students are explicitly directed to go back and make sense of their previous of friction vs. roughness in the light of the new phenomena studied.</p> <p>Purpose of the Activity: The purpose of this is to make students realize that their initial graph doesn't work in the light of the activities that were done.</p>
	<p>3.6 Modifying Graph</p> <p>Description of the Activity: Students are directed to modify their graph if they feel like it. Most students would make a graph that is shown below.</p> <div data-bbox="1015 1087 1349 1318" data-label="Figure"> </div> <p style="text-align: center;"><i>Typical Modified Graph</i></p> <p>Purpose of the Activity: This activity put the students in a mode of making a new graph that shows that friction is high when both surfaces are smooth and also when the surfaces are really both rough (like the sandpaper).</p>

COMMENTS	ACTIVITY 3
	<p data-bbox="885 233 1365 268">3.7 Coming up with Consensus Ideas</p> <p data-bbox="885 306 1045 342">Description:</p> <p data-bbox="885 342 1437 485">Students are deliberately directed to discuss to each other their answers to the different questions in the handout and ask them to come up with a consensus idea.</p> <p data-bbox="885 562 1195 598">Purpose of the Activity:</p> <p data-bbox="885 598 1437 701">Make students collaborate in coming up with better explanations of friction at the atomic level.</p>
	<p data-bbox="885 1037 1187 1073">3.8 Writing Own Ideas</p> <p data-bbox="885 1110 1000 1146">Purpose:</p> <p data-bbox="885 1184 1437 1255">To establish individual student's ideas at this point of the activity.</p>

COMMENTS	ACTIVITY 3
	<p data-bbox="867 268 1192 300">3.9 Concept Introduction</p> <p data-bbox="867 304 1027 336">Description:</p> <p data-bbox="867 340 1437 409">In this part the following ideas are introduced:</p> <ul data-bbox="922 413 1437 632" style="list-style-type: none"> <li data-bbox="922 413 1437 483">▪ electrical interaction as a cause of friction</li> <li data-bbox="922 487 1437 556">▪ the real area of contact and not the geometric area affect friction</li> <li data-bbox="922 560 1437 632">▪ mathematically friction can be represented as <math>\mu N + cA</math>.</li> </ul> <p data-bbox="867 779 982 810">Purpose:</p> <p data-bbox="867 814 1437 957">The purpose of this part is either to further reinforce the ideas that students had just came up with or to further challenge their current ideas and reconstruct it.</p>

COMMENTS	ACTIVITY 3
	<p data-bbox="885 233 1365 268">3.10 Coming up with Consensus Idea</p> <p data-bbox="885 306 1045 342">Description:</p> <p data-bbox="885 380 1437 520">Students are deliberately directed to discuss to each other their answers to the different questions in the handout and ask them to come up with a consensus idea.</p> <p data-bbox="885 600 1192 636">Purpose of the Activity:</p> <p data-bbox="885 674 1437 772">Make students collaborate in coming up with better explanations of friction at the atomic level.</p>
	<p data-bbox="885 1115 1240 1150">3.11 Own Ideas of Friction</p> <p data-bbox="885 1230 1045 1266">Description:</p> <p data-bbox="885 1304 1437 1360">Students list down their own ideas about friction.</p> <p data-bbox="885 1482 997 1518">Purpose:</p> <p data-bbox="885 1556 1437 1654">This is to keep track of ideas that students have so far constructed from the different activities.</p>



COMMENTS	ACTIVITY 4
	<p data-bbox="862 233 1154 264">4.1 Balloon Activity</p> <p data-bbox="862 306 1437 516">Description of the Activity: Students model the wide and narrow sides in terms of different balloon arrangements. The wide side is modeled with more atoms on it and the narrower with fewer atoms on it.</p>  <p data-bbox="862 915 1437 1125">They rest the balloon arrangements on a paint tray and find out that the marks per atom on the arrangement for the narrower side are smaller in diameter than the ones for the wider side. But if they add all of the marks they end up being equal.</p> <p data-bbox="862 1247 1437 1377">Purpose: To make students realize that it's the real atomic contact that matters in talking about friction at the atomic level.</p>

Continuation of Balloon Activity

COMMENTS	ACTIVITY 4
	4.2 Balloon Activity

COMMENTS	ACTIVITY 4
	<p data-bbox="885 344 1365 375">4.3 Coming up with Consensus Ideas</p> <p data-bbox="885 491 1437 667">Description: Students are deliberately directed to discuss to each other their answers to the different questions in the handout and ask them to come up with a consensus idea.</p> <p data-bbox="885 747 1437 884">Purpose of the Activity: Make students collaborate in coming up with better explanations of friction at the atomic level.</p>
	<p data-bbox="885 1184 1437 1251">4.4 Own Ideas of Friction at the Atomic Level</p> <p data-bbox="885 1331 1240 1362">Description of the Activity:</p> <p data-bbox="885 1442 1437 1512">Students list down the ideas they now have after doing the activities.</p> <p data-bbox="885 1591 1437 1837">Purpose of the Activity: This provides opportunity for individual students to write what they learned. This part provide a context of establishing what ideas they now have after doing the activities.</p>

COMMENTS	ACTIVITY 4
	<p data-bbox="885 344 1209 375">4.4 Concept Introduction</p> <p data-bbox="885 417 1242 449">Description of the Activity:</p> <p data-bbox="885 491 1437 632">Here the friction when the wooden block is dragged along the wide and narrow sides are explained in terms of the equation</p> $\text{Friction} = \mu N + cA$ <p data-bbox="885 821 1193 852">Purpose of the Activity:</p> <p data-bbox="885 894 1437 999">This part provides a synthesis of what students should have gotten from the material.</p>

COMMENTS	ACTIVITY 4
	<p data-bbox="885 306 1317 338">4.5 Own Thoughts about Friction</p> <p data-bbox="885 380 1240 411">Description of the Activity:</p> <p data-bbox="885 453 1430 520">Students list down the ideas they now have after doing the activities.</p> <p data-bbox="885 636 1195 667">Purpose of the Activity:</p> <p data-bbox="885 709 1430 884">This provides opportunity for individual students to write what they learned. This part provide a context of establishing what ideas they now have after doing the activities.</p>

**What problems might STUDENTS have in using the instructional material in terms of the following?**

*Content:*

---

---

---

---

---

*Sequencing of Activities:*

---

---

---

---

**What do you suggest in addressing the issues you raised above?**

*Content:*

---

---

---

---

---

*Sequencing of Activities:*

---

---

---

---

---

**What problems might INSTRUCTORS have in using the instructional material in terms of the following?**

**Content:**

---

---

---

---

---

**Activities/ Sequencing of Activities:**

---

---

---

---

---

---

---

---

**What do you suggest in addressing the issues you raised above?**

**Content:**

---

---

---

---

---

---

---

---

**Activities/Sequencing of Activities:**

---

---

---

---

---

---

---

---

## Revised Version based on Expert's Feedback

### WHEN THINGS GET ROUGH

#### Introduction

At present, we are at the verge of several breakthroughs in nanoscience and technology. In medicine for example nanorobots would soon be able to enter our bodies to detect defects, destroy cancer cells, repair damaged cells or deliver drugs to specific organs in our body. In physics, nanotribologists are currently working on trying to understand the microscopic origin of friction. In our day to day experience friction plays an important role. For example when walking we need friction between our feet and the ground. On the other hand, friction also has its adverse effects (i.e. friction reduces the efficiency of your car's engine). Did you know that friction wastes about 20% of energy in your car's engine? By most estimates the economic cost of poor friction control is more than 6% of GNP which translates to ~ \$400 billion per year.

If nanotribologists succeed in pinning down the nanoscale origin of friction then we will have a better way of manipulating surfaces so that we can totally eliminate friction if desired. Microscopic engines and gears would soon be realities as microscopic circuits are today. Although friction on the microscopic scale has not yet been completely understood, nanotribologists are now establishing evidence of the disparity between friction at the microscopic and macroscopic level.

The series of activities below will guide you to rethink your ideas about friction. After going through them we hope that you will come up with a model of friction at the atomic level which is consistent with that of experts. Let's get started.



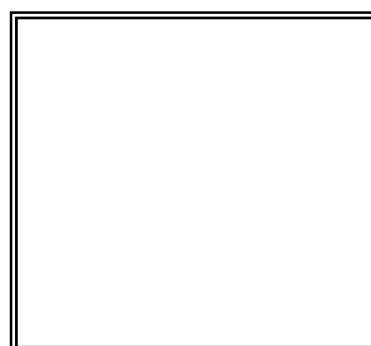
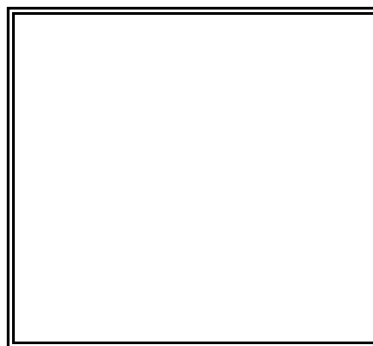
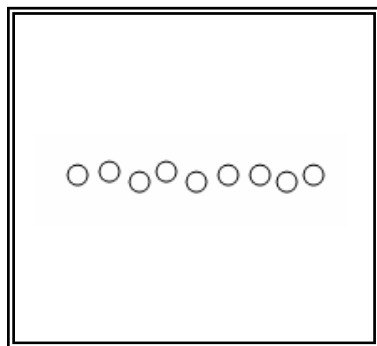
# Activity 1

1.1 Based on your experiences or science classes taken, please list down below your ideas about friction (e.g. what causes it, what factors affect it etc.)?



Your Ideas of friction

1.2. On your table you have a wooden block and a wooden plank with sandpaper on it. Feel the different surfaces (numbered 1, 2 and 3) by sliding your fingers across each. Zooming in at the level where you see the atoms, portions of the cross section of surface 1 is represented by the sketch below. The circles represent the atoms. How would you represent the other two surfaces?



*If surface 1 is dragged across surface 2 and all the way to surface 3 predict in which case you will have greater reading on the spring scale.*

**Prediction:**

---

What are the reasons for your prediction?

Reason/s:

---

---

1.3 Now actually drag surface 1 across surface 2 all the way to surface 3 using the spring scale. Observe what happens on the reading on the spring scale.

Observation:

---

---

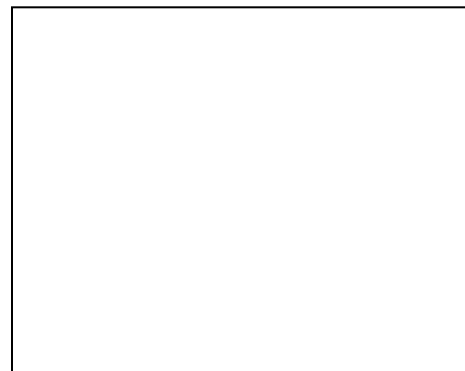
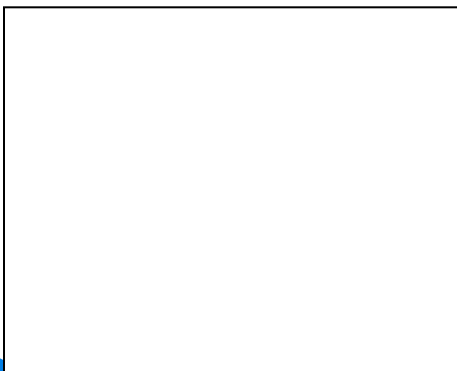
What is your explanation for your observation?

Explanation:

---

---

1.4 Sketch below the pairs of sliding surfaces at the level where you see the atoms. Please shade the atoms of one of the surfaces.



In which case is the friction greater in between the surfaces?

---

---



Based on your sketch, what is causing the friction in between the surfaces?

---

---



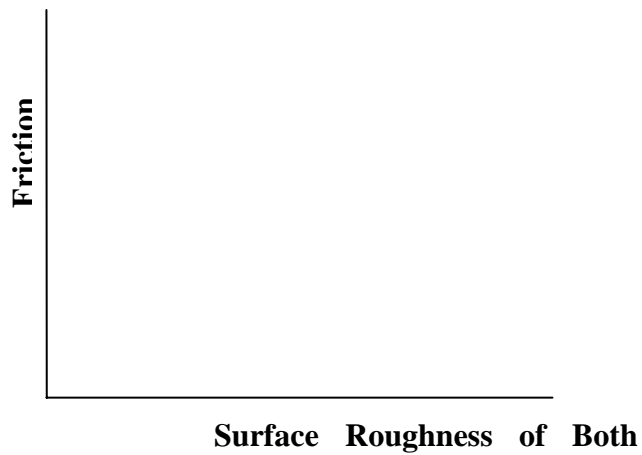
*What does this activity tell you about how the force needed to pull the wooden block across vary with surface roughness?*

---

---

---

Sketch how friction varies with surface roughness of both surfaces.



You are not expected to draw an exact graph. Just draw a graph to indicate overall trends, e.g. increasing, decreasing or constant.



Explain the details of your graph.



What happens to the friction force when we make two surfaces smoother and smoother?



1.6. Discuss with your group members your answers to the different questions and try to come up with a consensus answer.



Write your consensus idea/s about friction.

Factors Affecting Friction:

How Friction varies with Surface Roughness of Both Surfaces:



1.7 Write down below the ideas that you now have about friction.



## 1.8 Concept Introduction

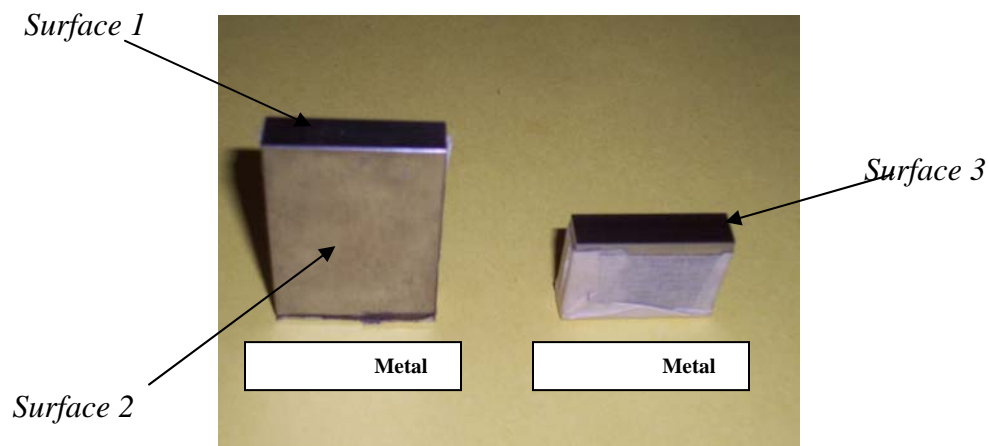
Macroscopically, the friction force between two surfaces is dependent on the type of materials ( $\mu$ ) that come into contact and the force that keeps the two surfaces together (the load or the normal force  $N$ ). It is given by the equation

$$\text{Friction force} = \mu N$$

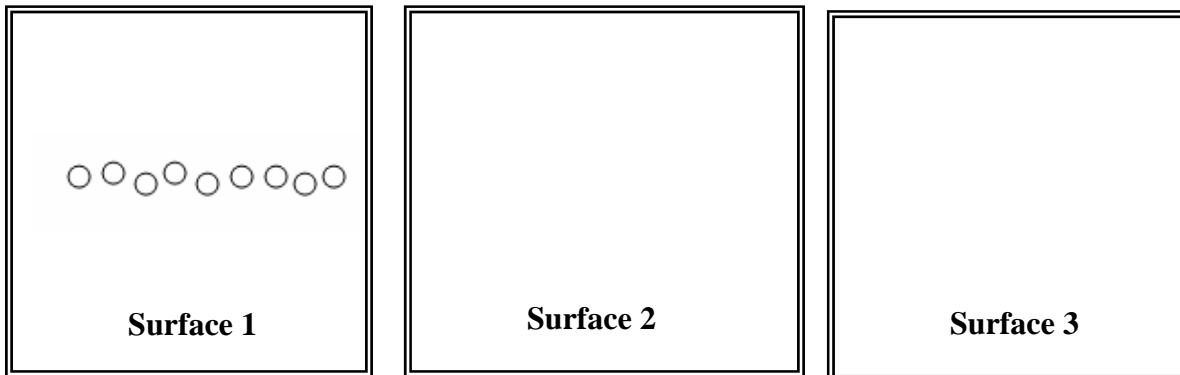
For certain degrees of roughness the coefficient of friction remains the same. And the friction force varies directly with the load or the normal force. The friction force also does not depend on the surface area. These empirical observations are referred to as Amonton's Law. But do these laws hold true at the atomic level? What happens to the friction when materials become microscopically smooth? The remaining activities will help you answer these questions.

## Activity 2

- 2.1 On your table you have two small metal blocks. Now, slide your **fingernails** across the **exposed surfaces** of metal block #1 and metal block #2. Please refer to the picture below.



Sketch how portions of the surfaces would look like to you at the level where you see the atoms like what you did previously in step 3.



? If we slide surface 3 across surface 1 and across surface 2, predict in which case you will have greater friction.

Prediction:

---

---

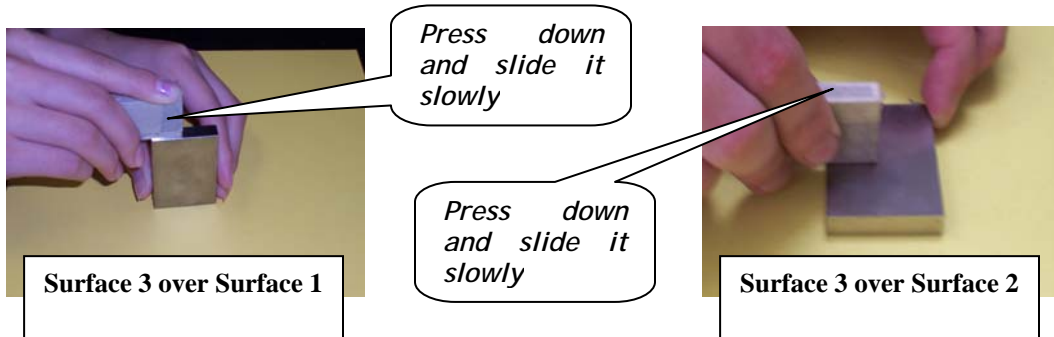
What are the reasons for your prediction?

Reason/s:

---

---

2.2 Now slide surface 3 across surface 1 and surface 2. You may want to press down on surface 3 and slide it real slow to see a more dramatic difference.



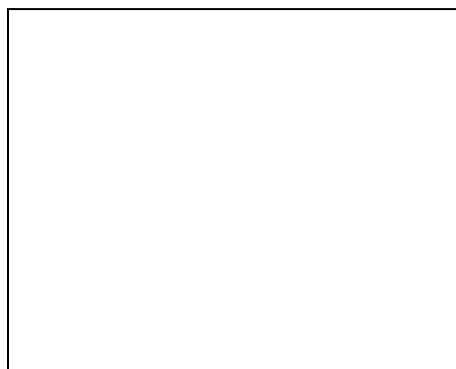
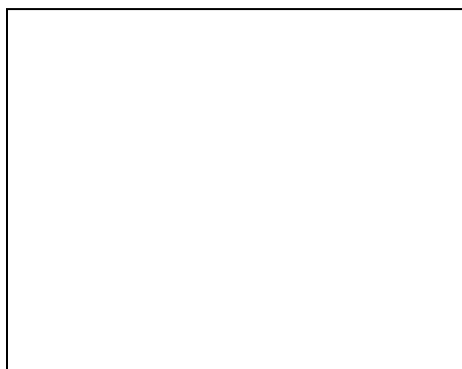
What did you observe? Was that what you predicted?

---

---

---

2.3 Sketch the pair of sliding surfaces at the level where you see the atoms.



Write down below an explanation for your observation (It's fine if you can't think of any explanation at the moment).

---

---

---

## Activity 3

3.1. On your table you have two sheets of papers and a transparency. It's time to play with them. Crumple one of the papers and then flatten it out as much as you can. Rest the **uncrumpled paper** over the transparency. Pull the paper across the transparency.



*What do you predict would happen to the force you need to pull the paper across, if the transparency is first rubbed with the fur?*

---

---

---



*Please explain your prediction.*

---

---

---

3.2 Now rub the transparency vigorously with the fur. Rest the **uncrumpled** paper on the transparency and pull it across.



What did you observe? Was that what you predicted?

---

---



What is causing the difference on the force that you need to pull in step 10 and step 11?

---

---



If we slide the crumpled paper after rubbing the transparency with the fur, how would the force needed to pull compare with the force you needed to pull the uncrumpled paper in step 11?

**Prediction:**

---

---

**Reason/s:**

---

---

Again, rub the transparency vigorously with the fur. Rest the **crumpled** paper on the transparency and pull it across.



What did you observe?

---

---



Please explain your observation.

---

---



What are the factors that affect the force that you needed to pull?

---

---



3.3. Sketch the pairs of sliding surfaces at the level where you see the atoms.



3.4 Now let us relate what you have just done with the metal block activity.



*What similarities/differences do you see between the metal block activity and the one that you just did with the papers and transparency?*

---

---



*How does the actual area in contact affect the force needed to pull one surface across another?*

---

---



*Can you now make an explanation for your observation in the metal block activity? Write down your explanation below.*

---

---



*So what happens to the friction force when we make two surfaces smoother and smoother?*

---

---

3.5 Now go back to the graph you made earlier regarding how friction varies with the surface roughness.



*Do you still agree with it? What happens to the friction force if we make two surfaces smoother and smoother, probably smoother than the metal blocks?*

---

---

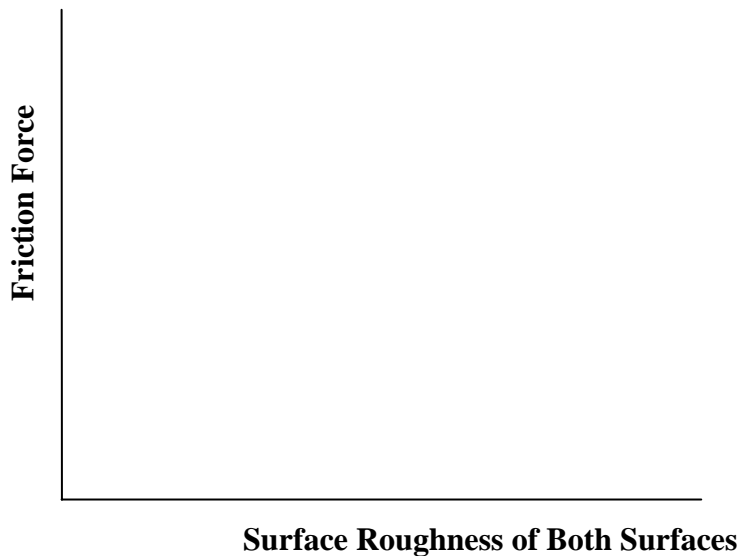


*What happens to the friction force if the metal surfaces become as rough as the sand paper?*

---

---

3.6 If you feel you need to modify your previous graph please sketch below your modified graph.



Explain below the details of your modified graph.

---

---

---



*Based on the activities that you did, what factors do we need to consider when determining the friction between two surfaces that are really smooth?*

---

---

---



*From the paper-transparency and metal block activities, what do those tell you about what might cause friction between two surfaces at the atomic level?*

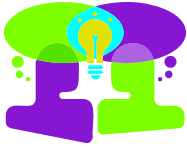
---

---

---



3.7 Discuss with your group members your answers to the different questions and try to come up with a consensus answer.



Please write your consensus idea/s on the box below.

Factors Affecting Friction:

How Friction varies with Surface Roughness of Both Surfaces:



3.8 Write your individual thoughts now about friction?



### 3.9 Concept Introduction

From the previous activities, you have seen that the **actual surface area** in contact **DOES** affect the friction force between two surfaces. Also, when surfaces become microscopically smooth, the force of friction does not actually go zero but actually it may be unexpectedly large. In this case some friction would be caused by electrical interactions. For some materials, like the metal blocks when they become atomically smooth the friction will be large because the atoms would then form bonds with each other.

A more accurate mathematical description of the friction force at the atomic level is given by

$$\text{Friction force} = \mu N + cA$$

where  $A$  here represents the real area of contact (area where atoms on opposing surfaces are close enough that they strongly interact) and  $c$  is a constant needed to overcome the interaction of an atom in the absence of load.



*For the metal block activity, in which case is the real area of contact  $A$  greater?*

---

---

---



*How about in the case of the crumpled and uncrumpled paper in which case is  $A$  greater?*

---

---

---



*Going back to the activity on the uncrumpled paper and transparency, what do you think happens to the value of  $c$  when the transparency was rubbed with the fur? Why?*

---

---

---



*Which term ( $\mu N$  or  $cA$ ) from the above equation dominates when the surfaces are roughened? Which dominates when the surfaces are made smoother?*

---

---



# Activity 4

4.1 Let's go back to the wooden block and the surface with sandpaper.

**?** *If we are to drag the wooden block along its wide and narrow sides across the sandpaper surface, in which case will you have to overcome greater friction? Why?*

**Prediction:**

---

---

---

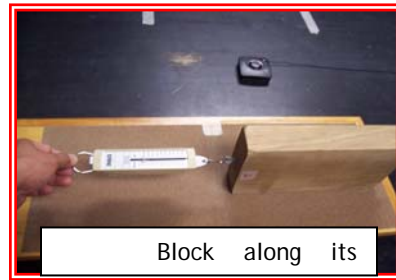
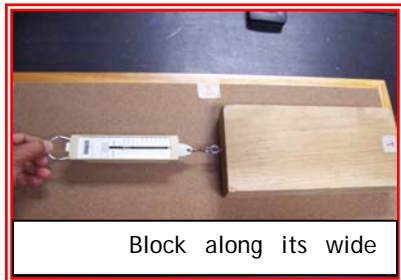
**Reason/s:**

---

---

---

Drag the wooden block along its wide side across the sandpaper. Note the reading on the spring scale. Repeat but this time drag the wooden block along its narrower side. **Do these several times and average the result.** *Be sure the spring scale is parallel to the wooden plank and it's not twisted.*



**Observation:**

---

---

**Explanation:**

---

---

? Suppose we represent atoms of the surfaces as balloons. Which of the balloon arrangements represent the wider side? and the narrow side?

---

---

---



4.2 Now smear paint all over the tray. Rest the balloon arrangement representing the wider side on the tray. Support it on the sides to prevent it from swaying. Just be sure you don't press down on it.

Remove the balloon arrangement from the tray.

? What do the marks on the balloons represent?

---

---

? What do you predict would happen to the marks if we do the same thing with the balloon arrangement representing the narrower side of the block? Why do you predict such?

*Prediction:*

---

---

*Reason/s:*

---

---



Now rest the balloon arrangement representing the narrow side on the tray. Again support it on the side to prevent it from swaying and be sure you don't press down on it. (Add a bit more of paint if necessary) .

Remove the balloon arrangement from the tray.



*What did you observe on the marks on each balloon in this case? Was this what you predicted?*

---

---



*If we combine the all the paint marks on each of the balloon arrangement, how would the total compare?*

---

---



*Can you now explain your observation regarding the wooden block dragged along its wide and narrow sides across the sandpaper?*

---

---



4.3 Discuss with your group members your answers to the different questions and try to come up with a consensus answer.



Please write your consensus idea/s on the box below.

Factors Affecting Friction:

How Friction varies with Area of Contact:



What are your thoughts now about friction at the atomic level?

Empty box for writing thoughts on friction at the atomic level.



x

#### 4.4 Concept Introduction

Let's analyze further why the friction is the same when the wooden block was dragged along its wide and narrow side. Recall that the friction force is more completely described by the equation

$$\text{Friction force} = \mu N + cA$$

Since the interacting surfaces are made of the same material (also the same smoothness), the value of  $\mu$  and  $c$  are essentially the same in each case. Whether the block is dragged along the wide and narrow side, the weight is also the same. So the first term in the above equation is the same in both situations. Also, you have seen from the balloon activity how the actual area of contact could be the same when the block is dragged along the wide and narrow side. The second term then is also the same for both cases. This explains why the overall friction is the same in this case.

For rough surfaces like the case of the sandpaper the  $\mu N$  term dominates, and as the materials gets rougher the friction increases. For some materials, when they become really smooth (metal block and the paper and transparency) the electrical interactions come into play and  $cA$  term dominates. For pairs of surfaces that tend to bond to each other  $c$  would be greater. You have seen from the previous activities (metal blocks, crumpled vs. uncrumpled paper, wooden block on its wide and narrow side) that the geometric area is not essentially the one affecting the friction force but rather the actual area of contact  $A$  between the surfaces. The actual contact  $A$  increases as the surfaces become smoother because you will have more atoms interacting (electrical) between the two surfaces.



4.5 Based on the activities you did, write down below your own thoughts now about friction at the atomic level?

Cause of friction at the atomic level:

Factors Affecting Friction:



Please write down below confusions that you have that you want to be clarified by your instructor.

Empty box for writing confusions.

At this point discuss your new ideas with your instructor.

## Appendix L - Students' Feedback Questionnaire

### QUESTIONNAIRE

**Physics Class/es Taken:** \_\_\_\_\_ **Major:** \_\_\_\_\_

*Directions: Please indicate your agreement and disagreement to the following statements regarding the instructional material "WHEN THINGS GET ROUGH" by ticking on the appropriate column. Your responses will provide great help for us in improving the developed instructional material as well as its implementation.*

STATEMENT	Strongly disagree	Disagree	Neutral	Agree	Strongly agree
1. The objectives of the instructional material are clear to me.					
2. I find the topic in the instructional material interesting.					
3. The level of difficulty of the material is just right for me.					
4. I find the activities interesting.					
5. The activities helped me build better ideas about friction at the atomic level.					
6. The instructions for the activities are clear.					
7. The activities challenged me to re/think critically about my prior ideas regarding friction.					
8. The activities are properly sequenced in a way that helped me progressively develop a better model about friction at the atomic level.					
9. I would like the activities to be incorporated in my general physics laboratory class.					
10. I learned a lot from the activities.					
11. The instructional material helped me come up with ideas that I had never thought before.					
12. The instructional material helped me construct my own ideas.					

Please write down below your other comments regarding the developed instructional material:

---



---



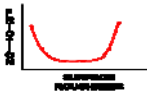
---



---

THANKS A LOT !!!!!

## Appendix M - Table of Specifications (Micro-Friction Test)

<b>Table of Specifications</b>	
Target Ideas	Item Number/s
<ul style="list-style-type: none"> <li>• Friction is due to electrical interactions between atoms.</li> </ul>	2,3,4,5
<ul style="list-style-type: none"> <li>• Friction is dependent on the atomic contact area.</li> </ul>	1,5,7,
<ul style="list-style-type: none"> <li>• Friction varies with roughness as in the Figure below:   </li> </ul>	6,8,9
<ul style="list-style-type: none"> <li>▪ Friction on atomically smooth surfaces is large</li> </ul>	5,9
<ul style="list-style-type: none"> <li>• Atomic friction is described by the equation <math>f = \mu N + cA</math></li> </ul>	5,9,10

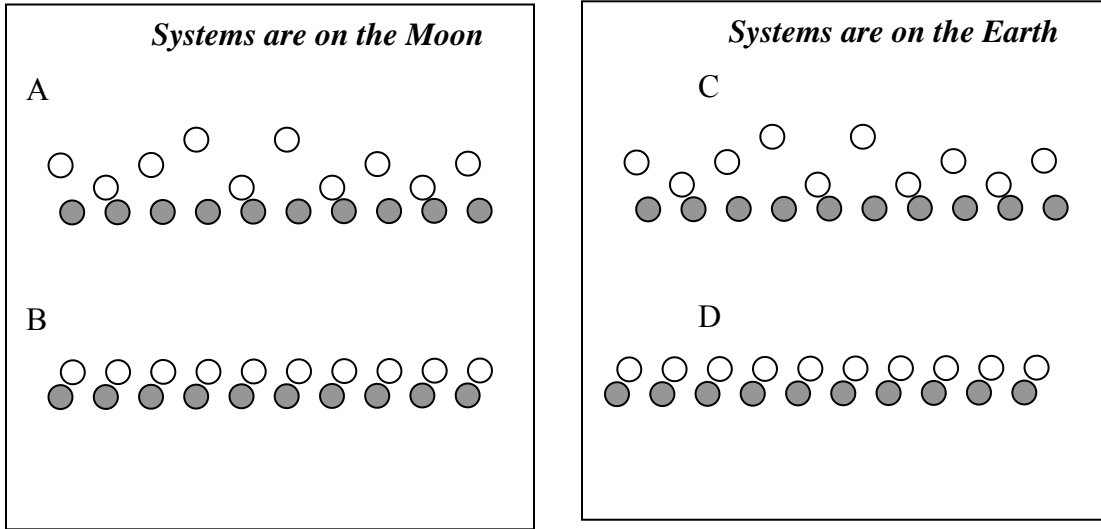
## Appendix N - Micro-Friction Test

### Initial Version

**Multiple Choice:** Read the following questions carefully. Circle the letter of the best answer from the choices provided.

1. What happens to the friction force between two smooth metal blocks when they are made smoother and smoother?
  - A. The friction force decreases because there will be less atoms catching each other.
  - B. The friction force decreases because there will be less ridges that will interlock.
  - C. The friction force increases because there will be more atoms interacting.
  - D. The friction force increases because there will be more ridges that interlock.
2. What happens to the friction force between two rough surfaces when they are made rougher and rougher?
  - A. The friction force decreases because there will be less atoms catching each other.
  - B. The friction force decreases because there will be less ridges that will interlock.
  - C. The friction force increases because there will be more atoms interacting.
  - D. The friction force increases because there will be more ridges that interlock.
3. Which of the following is NOT TRUE about friction at the atomic level?
  - A. Friction at the atomic level arises from the electrical interactions between the atoms.
  - B. The greater the real area of contact between two surfaces the greater would be the friction.
  - C. The amount of friction when materials become weightless is dependent on the type of surfaces that come into contact.
  - D. Friction at the atomic level is zero if the weight is zero.
4. What happens to the friction force between two materials if they are made to move across (by a force parallel to the surfaces in contact) each other in a space shuttle where the materials are weightless?
  - A. The friction force would approach zero because the materials are weightless.
  - B. The friction is not necessarily zero because of electrical interactions.
  - C. The friction force will not be affected by the roughness of the material.
  - D. The friction force will not be affected by the area of contact.
5. Friction at the atomic level arises from
  - A. rubbing between atoms.
  - B. interlocking of atoms.
  - C. electrical interactions between atoms.
  - D. gravitational force pushing down on the atoms.

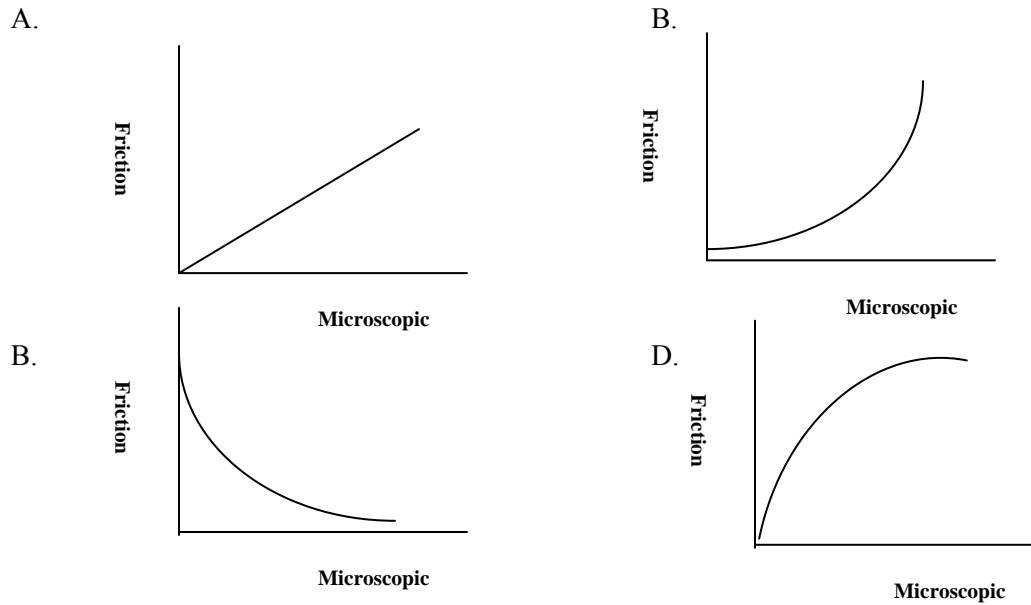
6. The following drawings show pairs of surfaces that move across each other. The circles represent atoms.



Which of the following gives the arrangement of the systems starting with the highest friction to the system with lowest friction?

- A.  $A > B > C > D$       B.  $D > B > C > A$       C.  $C > D > A > B$       D.  $D > C > B > A$

7. Which of the following shows the variation of friction with microscopic (atomic level) roughness?





8. What is TRUE about the friction in a wooden block dragged along its narrow and wide side?

- A. Friction is the same because friction does not depend on surface area of contact.
- B. Friction is the same because the area touching is the same.
- C. Friction is different because the surfaces have different geometric areas.
- D. Friction is different because the normal force is different.

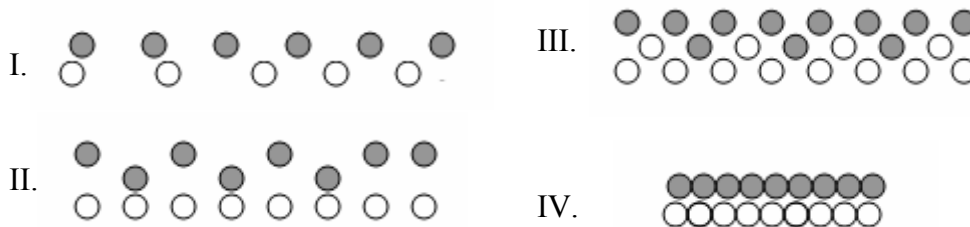
9. Consider the following statements regarding friction:

- I. For rough surfaces, the friction increases as we make the surfaces rougher and rougher.
- II. For smooth surfaces, the friction force increases as we make the surfaces smoother and smoother.
- III. The amount of friction is zero when the objects become weightless.

Which of the above statements are TRUE?

- A. I & II
- B. II & III
- C. I & III
- D. I, II & III

10. In the figures below which would create the greatest friction?



- A. I & IV
- B. II & III
- C. II & IV
- D. III & IV

11. Which of the following affects the friction between two surfaces at the atomic level?

- I. Strength of electrical interactions
- II. Normal force
- III. Real Area of Contact
- IV. Coefficient of friction

- A. II & IV
- B. I & III
- C. II, III & IV
- D. I, II, III & IV

## Final Version



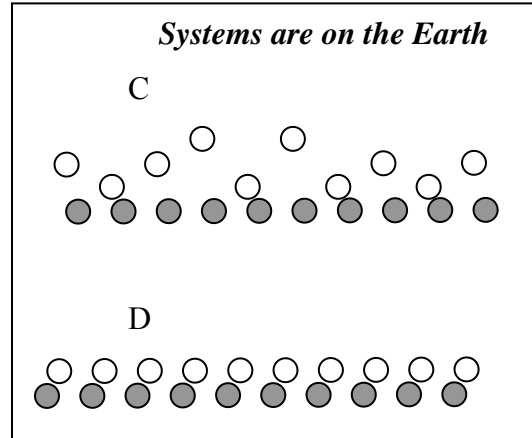
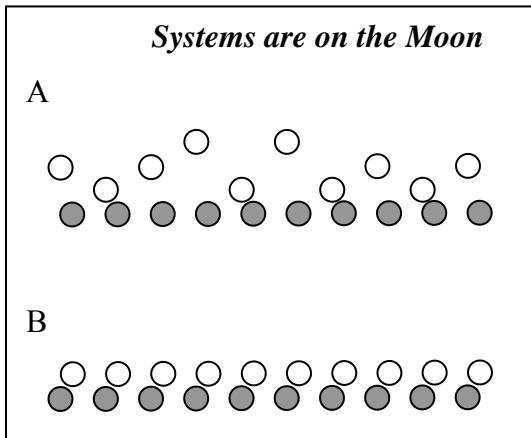
## ASSESSMENT

### “When Things Get Rough”

**Multiple Choice:** Read the following questions carefully. Circle the letter of the best answer from the choices provided.

1. What happens to the friction force between two smooth metal blocks when they are made smoother and smoother?
  - A. The friction force decreases because there will be less atoms catching each other.
  - B. The friction force decreases because there will be less ridges that will interlock.
  - C. The friction force increases because there will be more atoms interacting.
  - D. The friction force increases because there will be more ridges that interlock.
2. Which of the following is NOT TRUE about friction at the atomic level?
  - A. Friction at the atomic level arises from the electrical interactions between the atoms.
  - B. The greater the real area of contact between two surfaces the greater would be the friction.
  - C. The amount of friction when materials become weightless is dependent on the type of surfaces that come into contact.
  - D. Friction at the atomic level is zero if the weight is zero.
3. What happens to the friction force between two materials if they slide across each other in a weightless environment, such as in the space shuttle?
  - A. The friction force would approach zero because the materials are weightless.
  - B. The friction is not necessarily zero because of electrical interactions.
  - C. The friction force will not be affected by the roughness of the material.
  - D. The friction force will not be affected by the area of contact.
5. If two surfaces are made extremely smooth so that they both have completely flat layers of atoms, then what is the leading cause of friction between these two surfaces?
  - A. Rubbing between atoms.
  - B. Interlocking of atoms.
  - C. Electrical interactions between atoms.
  - D. Weight of one layer of atoms pushing down on the other layer of atoms.

For item 5 and item 6 consider the sketches below showing pairs of surfaces that move across each other. The circles represent atoms. The shaded circles are atoms on one surface, the unshaded circles are atoms on a different surface that is resting on top of it.



5. Which system gives the greatest friction?

A.) EarthX

B.) EarthY

C.) MoonX

D.) MoonY

6. Which system gives the greatest friction?

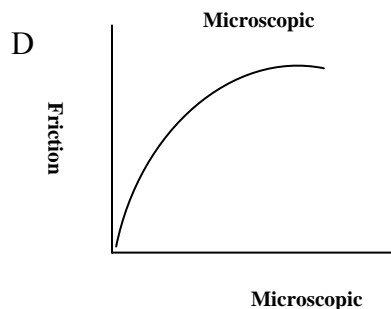
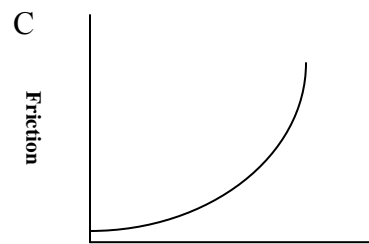
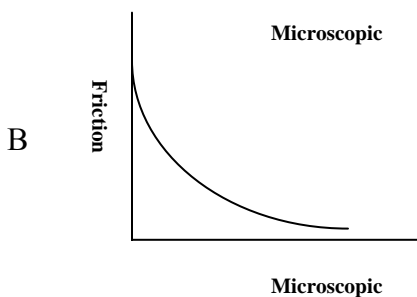
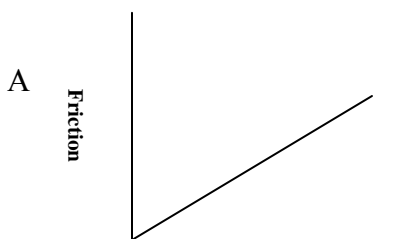
A.) EarthX

B.) EarthY

C.) MoonX

D.) MoonY

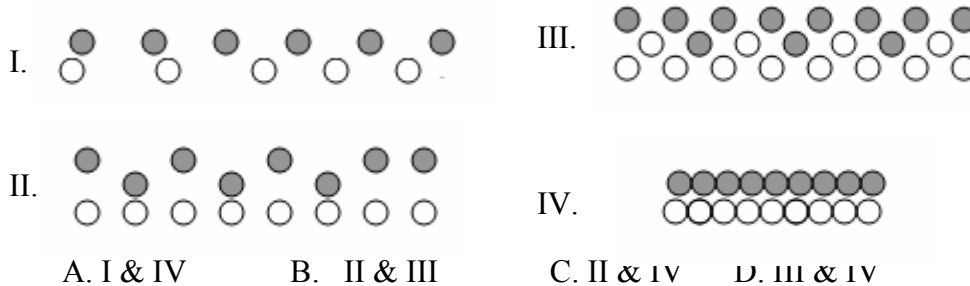
7. Which of the following shows the variation of friction with microscopic (atomic level) roughness?



8. What is the BEST explanation regarding friction when a rectangular wooden block dragged along on its narrow side versus when it is dragged on its wide side?

- A. Friction is the same whether it is dragged on its narrow side or on its wide side because friction does not depend on surface area of contact.
- B. Friction is the same whether it is dragged on its narrow side or on its wide side because the area of touching is the same.
- C. Friction is different depending on whether it is dragged on its narrow side or on its wide side because the surfaces have different areas in the two cases.
- D. Friction is different depending on whether it is dragged on its narrow or on its wide side because the force exerted by the block on the surface is different in the two cases.

9. In the figures below the shaded and unshaded circles represent atoms on two different surfaces. Which would create the greatest friction?



10. Which of the following affects the friction between two surfaces at the atomic level?

- I. Strength of electrical interactions
- II. Normal force
- III. Real Area of Contact
- IV. Coefficient of friction

## Appendix O - i-CARE

During the session, you may have encountered situations that caused:

- (1) Differences between your predictions (or what you believed) and the results of an experiment.
- (2) Differences between your understanding of one experiment and your understanding of another experiment.
- (3) Differences between your opinions and the opinions of other group members.
- (4) Differences between your opinions (or what you believed) and the opinions of the instructor.

When someone encounters such differences, he/she may have different kinds of experiences such as

- A. *The differences surprised me.*
- B. *The differences increased my interests in the topic.*
- C. *The differences made me want to pay more attention to the topic and spend more time to work on it.*

In the following table, please identify the experiments that may have given rise to the different situations discussed above. Identify the situations with (1) ~ (4) and your experience with A, B, C (see above). **Select all that apply.** You may add your own categories if not listed. If you need more space and/or have more comments, use the back of the page.

Experiment ID	The situation that causes differences	Your experiences with the difference	Now, can you completely resolve the experiment by yourself?
<b>Activity 1</b>	<input type="checkbox"/> (1) <input type="checkbox"/> (2) <input type="checkbox"/> (3) <input type="checkbox"/> (4)	<input type="checkbox"/> A <input type="checkbox"/> B <input type="checkbox"/> C	<input type="checkbox"/> Yes <input type="checkbox"/> No
<b>Activity 2</b>	<input type="checkbox"/> (1) <input type="checkbox"/> (2) <input type="checkbox"/> (3) <input type="checkbox"/> (4)	<input type="checkbox"/> A <input type="checkbox"/> B <input type="checkbox"/> C	<input type="checkbox"/> Yes <input type="checkbox"/> No
<b>Activity 3</b>	<input type="checkbox"/> (1) <input type="checkbox"/> (2) <input type="checkbox"/> (3) <input type="checkbox"/> (4)	<input type="checkbox"/> A <input type="checkbox"/> B <input type="checkbox"/> C	<input type="checkbox"/> Yes <input type="checkbox"/> No
<b>Activity 4</b>	<input type="checkbox"/> (1) <input type="checkbox"/> (2) <input type="checkbox"/> (3) <input type="checkbox"/> (4)	<input type="checkbox"/> A <input type="checkbox"/> B <input type="checkbox"/> C	<input type="checkbox"/> Yes <input type="checkbox"/> No

From the experiments you listed, select one that had the most impression to you and use it as the basis for answering the questions listed below: ►

**Write down the experiment ID that you have selected (\_\_\_\_\_).**

1. The result of this experiment confused me.

1                      2                      3                      4                      5

NOT AT ALL TRUE      SOMEWHAT TRUE      VERY TRUE

2. Since I cannot solve the differences, I am uncomfortable.

1                      2                      3                      4                      5

NOT AT ALL TRUE      SOMEWHAT TRUE      VERY TRUE

3. I am upset because I cannot understand the reason for the result.

1                      2                      3                      4                      5

NOT AT ALL TRUE      SOMEWHAT TRUE      VERY TRUE

4. Now add your answers to the above three questions and put **the number** here: (\_\_\_\_\_)

► If your number in 4 is less than 9 (3~8), please go to **Part 1** only, otherwise (9~15) go to **Part 2** only.



**Part 1 (Finish this part if your calculated number 3~8):** Among the following sentences, **check the number** that best describes how true it is of you about the cause of the above feelings.

- 1. Before the experiment, I predicted multiple possible outcomes. From the experiment, I have seen one of my predictions proved. So I am satisfied with the experiment result even without detailed explanations.
- 2. I was confident that by reevaluating my previous beliefs, I would be able to find an explanation without others' help.
- 3. I accepted what instructors or my classmates had said. I didn't spend much effort to find an explanation on my own.
- 4. I made my predictions for this experiment by thinking about my past experience. I also tried to make sense of what I saw in the experiment based on my understandings through that experience.
- 5. Other causes of the above feelings involved with this experiment (please specify): (Use the back of the page.)

**Part 2 (Finish this part if your calculated number 9~15):** Among the following sentences, **check the number** that best describes how true it is of you about the cause of the above feelings.

- 1. Before the experiment, I was highly confident in my previous understandings of the subject. However, my understanding seems to be inconsistent with the outcome of the experiment.
- 2. After I saw the experiment's outcome, I tried to explain it by considering things that I might have ignored as I was making the predictions.
- 3. I believe that there must be good reasons that can explain the experiment well. But right now I don't think I have learned enough physics to build a good explanation yet.
- 4. On this experiment, the results are inconsistent with what I expected based on my experience and I haven't been able to resolve the problem yet.
- 5. Other causes of the above feelings involved with this experiment (please specify): (Use the back of the page.)

During the session, you may have encountered situations that caused:

- (1) Differences between your predictions (or what you believed) and the results of an experiment.
- (2) Differences between your understanding of one experiment and your understanding of another experiment.
- (3) Differences between your opinions and the opinions of other group members.
- (4) Differences between your opinions (or what you believed) and the opinions of the instructor.

## Appendix P - Sample Worksheets

3.3. Sketch the pairs of sliding surfaces at the level where you see the atoms.



3.6 Now let us relate what you have just done with the metal block activity.



*What similarities/differences do you see between the metal block activity and the one that you just did with the papers and transparency?*

---

---



*How does the actual area in contact affect the force needed to pull one surface across another?*

---

---



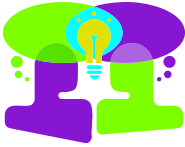
*Can you now make an explanation for your observation in the metal block activity? Write down your explanation below.*

---

---



**3.7** Discuss with your group members your answers to the different questions and try to come up with a consensus answer.



**Please write your consensus idea/s on the box below.**

**Factors Affecting Friction:**

**How Friction varies with Surface Roughness of Both Surfaces:**

**Cause of friction at the atomic level:**



**3.8 Write your individual thoughts now about friction?**



## Appendix Q - T-test Results (Students' Perceptions of the Material)

Item # 1. Objectives of the instructional material are clear		
	<i>Item 1 (CP)</i>	<i>Item 1 (GP)</i>
Mean	4.21875	4.352941
Variance	0.36996	0.367647
Observations	32	17
Hypothesized Mean Difference	0	
Df	33	
t Stat	-0.73661	
P(T<=t) one-tail	0.233283	
t Critical one-tail	1.69236	
P(T<=t) two-tail	0.466565	
t Critical two-tail	2.034515	
No significant difference at 0.05 level		

Item # 2. Topic is interesting		
	<i>Item2 (CP)</i>	<i>Item 1 (GP)</i>
Mean	4.21875	3.823529
Variance	0.36996	0.654412
Observations	32	17
Hypothesized Mean Difference	0	
Df	26	
t Stat	1.76649	
P(T<=t) one-tail	0.044527	
t Critical one-tail	1.705618	
P(T<=t) two-tail	0.089054	
t Critical two-tail	2.055529	
Significant difference at 0.05 level (one-tailed)		

Item # 3. Difficulty of the material is just right		
	<i>Item3 (CP)</i>	<i>Item 3 (GP)</i>
Mean	4.0000	4.058824
Variance	0.451613	0.308824
Observations	32	17
Hypothesized Mean Difference	0	
Df	39	
t Stat	-0.32741	
P(T<=t) one-tail	0.372555	
t Critical one-tail	1.684875	
P(T<=t) two-tail	0.745109	
t Critical two-tail	2.022691	
No significant difference at 0.05 level		

Item # 4. Difficulty of the material is just right		
	<i>Item4 (CP)</i>	<i>Item 4 (GP)</i>
Mean	4.4375	4.117647
Variance	0.254032	0.360294
Observations	32	17
Hypothesized Mean Difference	0	
Df	28	
t Stat	1.873972	
P(T<=t) one-tail	0.035702	
t Critical one-tail	1.701131	
P(T<=t) two-tail	0.071405	
t Critical two-tail	2.048407	
Significant difference at 0.05 level (one-tailed)		

Item # 5. Activities helped me build better ideas about friction at the atomic level..		
	<i>Item 5 (CP)</i>	<i>Item 5 (GP)</i>
Mean	4.65625	4.588235
Variance	0.361895	0.257353
Observations	32	17
Hypothesized Mean Difference	0	
Df	38	
t Stat	0.418224	
P(T<=t) one-tail	0.339069	
t Critical one-tail	1.685954	
P(T<=t) two-tail	0.678137	
t Critical two-tail	2.024394	
No significant difference at 0.05 level		

Item # 7. Activities challenged me to re/think critically about my prior ideas regarding friction.		
	<i>Item 7 (CP)</i>	<i>Item 7 (GP)</i>
Mean	4.71875	4.529412
Variance	0.208669	0.264706
Observations	32	17
Hypothesized Mean Difference	0	
Df	30	
t Stat	1.273862	
P(T<=t) one-tail	0.106247	
t Critical one-tail	1.697261	
P(T<=t) two-tail	0.212493	
t Critical two-tail	2.042272	
No significant difference at 0.05 level		

Item # 6 Instructions for the activities are clear..		
	<i>Item 6 (CP)</i>	<i>Item 6 (GP)</i>
Mean	4.0625	4.294118
Variance	0.576613	0.345588
Observations	32	17
Hypothesized Mean Difference	0	
Df	41	
t Stat	-1.18277	
P(T<=t) one-tail	0.121857	
t Critical one-tail	1.682878	
P(T<=t) two-tail	0.243713	
t Critical two-tail	2.019541	
No significant difference at 0.05 level		

Item # 8 activities are properly sequenced in a way that helped me progressively develop a better model about friction at the atomic level.		
	<i>Item 8 (CP)</i>	<i>Item 8 (GP)</i>
Mean	4.65625	4.588235
Variance	0.361895	0.257353
Observations	32	17
Hypothesized Mean Difference	0	
Df	41	
t Stat	0.418224	
P(T<=t) one-tail	0.121857	
t Critical one-tail	1.685954	
P(T<=t) two-tail	0.678137	
t Critical two-tail	2.024394	
No significant difference at 0.05 level		

Item # 9. I would like the activities to be incorporated in my physics laboratory class.		
	<i>Item9 (CP)</i>	<i>Item 9 (GP)</i>
Mean	4.15625	3.882353
Variance	0.458669	0.610294
Observations	32	17
Hypothesized Mean Difference	0	
Df	38	
t Stat	1.22206	
P(T<=t) one-tail	0.115763	
t Critical one-tail	1.699127	
P(T<=t) two-tail	0.231525	
t Critical two-tail	2.04523	
No significant difference at 0.05 level		

Item # 11. The instructional material helped me come up with ideas that I had never thought before.		
	<i>Item11 (CP)</i>	<i>Item 11 (GP)</i>
Mean	4.625	4.176471
Variance	0.370968	0.404412
Observations	32	17
Hypothesized Mean Difference	0	
Df	32	
t Stat	2.384524	
P(T<=t) one-tail	0.011599	
t Critical one-tail	1.693889	
P(T<=t) two-tail	0.023198	
t Critical two-tail	2.036933	
Significant difference at 0.05 level (one-tailed)		

Item # 10. I learned a lot from the activities.		
	<i>Item10 (CP)</i>	<i>Item 10 (GP)</i>
Mean	4.5	4.176471
Variance	0.322581	0.404412
Observations	32	17
Hypothesized Mean Difference	0	
Df	38	
t Stat	1.75796	
P(T<=t) one-tail	0.044477	
t Critical one-tail	1.697261	
P(T<=t) two-tail	0.088955	
t Critical two-tail	2.042272	
Significant difference at 0.05 level (one-tailed)		

Item # 12. The instructional material helped me construct my own ideas.		
	<i>Item12 (CP)</i>	<i>Item 12 (GP)</i>
Mean	4.4375	4.176471
Variance	0.383065	0.279412
Observations	32	17
Hypothesized Mean Difference	0	
Df	32	
t Stat	1.54874	
P(T<=t) one-tail	0.064867	
t Critical one-tail	1.685954	
P(T<=t) two-tail	0.129733	
t Critical two-tail	2.024394	
No Significant difference at 0.05 level		